

contardi

 **contardi**

**Contardi lights up residential and hospitality spaces with sophisticated creations born from a tailored approach, defined by exceptional quality, commitment to client satisfaction, and great flexibility.**

**Contardi illumina ambienti residenziali e hospitality con creazioni raffinate frutto di un approccio sartoriale, contraddistinto da eccellenza qualitativa, attenzione al cliente e grande flessibilità.**

## The archi-decorative style

Contardi Lighting's style is defined as 'archi-decorative,' a style in which a harmonious balance between aesthetics and functionality is achieved through the convergence of several elements: the variety of materials used, the elegance of the finishes, and the bespoke approach, on one hand, which define the unmistakable character of each design, and on the other, technological innovation, adherence to the highest safety standards, and compliance with all the required certifications for various markets. For Contardi Lighting, a decorative lighting object is an ambitious and sophisticated product: it must be able to illuminate and do so masterfully.

## Design and production Made in Italy

Contardi Lighting is based in Brianza, a region internationally recognized as the ultimate furniture district and the cradle of Italian design.

This is where Contardi products come to life, sometimes conceived and developed in-house, and sometimes the result of coordination with the creative flair of international designers. These designers work closely with the company's technical office, which, thanks to its vast experience, creates products of extraordinary quality and attention to detail. Local, "zero-mile" production, entrusted to carefully selected suppliers within the Brianza district, ensures the renowned quality of "Made in Italy," appreciated and recognized worldwide through decades of industry experience.

## Lo stile archi-decorativo

Lo stile di Contardi Lighting si definisce archi-decorativo ovvero uno stile in cui l'armonioso equilibrio tra estetica e funzionalità è ottenuto dal confluire di diversi elementi: la varietà dei materiali impiegati, l'eleganza delle finiture e l'approccio sartoriale, da un lato, che definiscono il carattere inconfondibile di ogni proposta e dall'altro, l'avanguardia tecnologica, il rispetto dei più elevati standard in termini di sicurezza e il possesso di tutte le certificazioni richieste dai vari mercati. Per Contardi Lighting l'oggetto luminoso decorativo è un prodotto ambizioso e sofisticato: deve saper illuminare e farlo magistralmente.

## Il design e la produzione Made in Italy

Contardi Lighting ha sede in Brianza, territorio riconosciuto a livello internazionale come il distretto per eccellenza dell'arredo e culla del design italiano.

È qui che prende vita il design dei prodotti Contardi, talvolta concepiti e sviluppati internamente, talvolta frutto del coordinamento con l'estro creativo di designer internazionali. Questi ultimi collaborano strettamente con l'ufficio tecnico dell'azienda, che grazie alla sua vasta esperienza, dà origine a prodotti di straordinaria qualità e cura dei dettagli. La produzione locale, a "chilometro zero", affidata a fornitori accuratamente selezionati nel distretto brianzolo, attraverso decenni di esperienza nel settore, assicura la rinomata qualità del Made in Italy, apprezzata e riconosciuta in tutto il mondo.

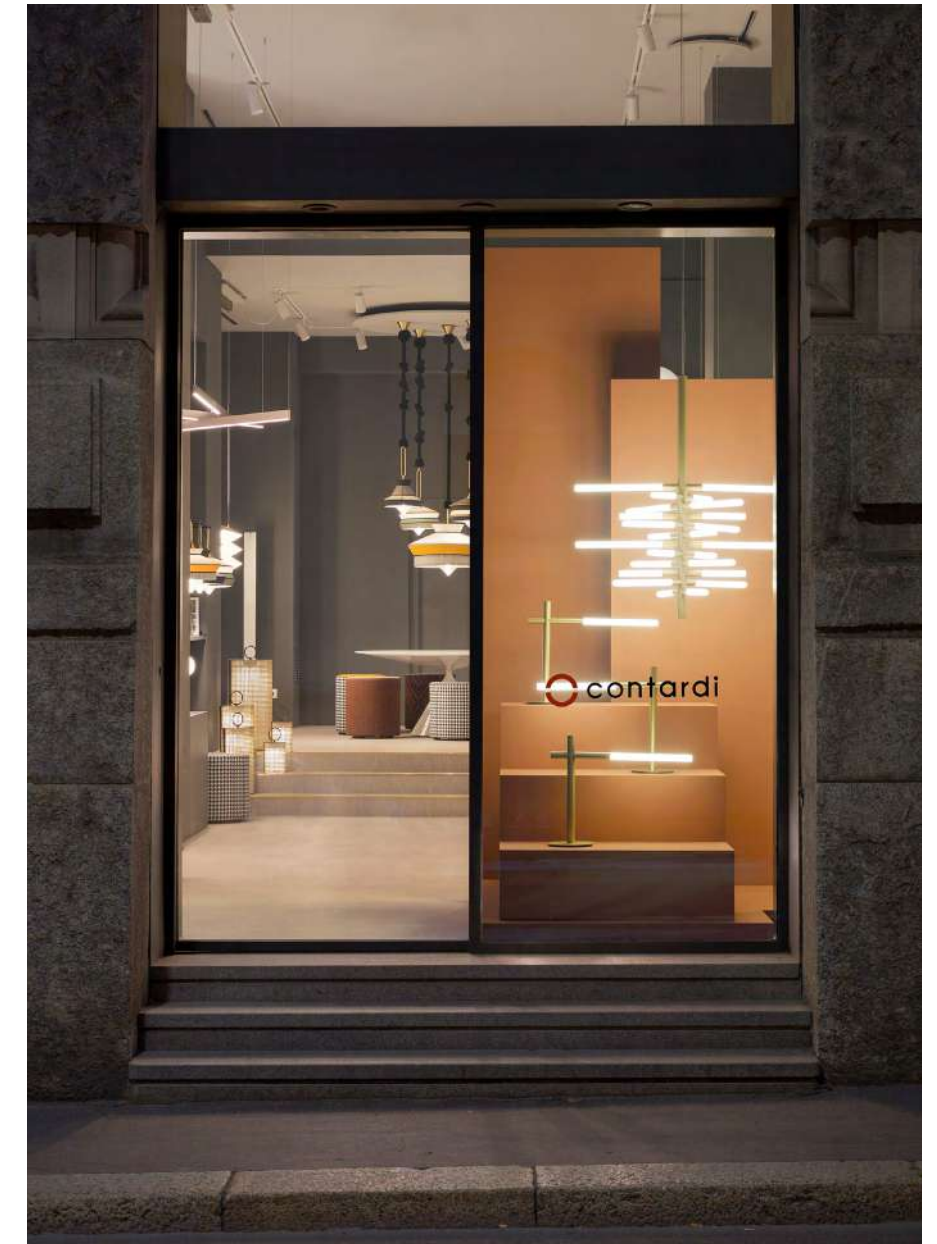



Hotel La Palma - Capri, Italia

## Design expertise and the tailored approach

Through close collaboration with architects, interior designers, and lighting consultants, Contardi Lighting has developed a strong network of professionals over the years, who turn to the brand for effective solutions in an increasingly sophisticated and demanding market. Contardi stands out for its versatile and customizable offerings and, thanks to its **Contract division**, is able to meet both aesthetic and functional needs, and for its flexible service that adapts to every project in terms of design and budget. Recognized as the "Couturier of Light," the company plays a key role in prestigious international projects, including hotels, restaurants, and yachts.

### MODIFIED STOCK

Contardi Lighting provides great flexibility in adapting its catalog offerings, allowing modifications in size, materials, and finishes, even for small order quantities.

### VALUED ENGINEERED

Upon request, **Contardi Contract division** can streamline the technology of its products to meet budget constraints, while maintaining quality and performance.

### BESPOKE

With its in-house research and development department, **Contardi Contract division** creates custom-made solutions, turning ideas into finished products for high-end projects or large-scale orders.

## L'expertise nel progetto e l'approccio su misura

Contardi Lighting, grazie alla stretta collaborazione con architetti, interior designer e consulenti di illuminazione, ha creato negli anni un solido network di professionisti che trovano nel brand risposte efficaci per un mercato sempre più evoluto ed esigente.

Contardi si distingue infatti per un'offerta versatile e personalizzabile e grazie alla **divisione Contract**, è capace di soddisfare esigenze estetiche e funzionali, e per il servizio flessibile che si adatta a ogni progetto, sia per design che per budget. Riconosciuta come il "couturier della luce", l'azienda è protagonista di prestigiosi progetti internazionali in hotel, ristoranti e yacht.

### MODIFIED STOCK

Contardi Lighting offre grande flessibilità nel modificare le proposte a catalogo per misure, materiali e finiture, anche con minimi d'ordine ridotti.

### VALUED ENGINEERED

Su richiesta, **Contardi divisione Contract** può semplificare la tecnologia dei propri prodotti per rispettare vincoli di budget, mantenendo qualità e resa.

### BESPOKE

Grazie al dipartimento di ricerca e sviluppo interno, **Contardi divisione Contract** realizza soluzioni su misura, trasformando idee in prodotti finiti per progetti di prestigio o con volumi significativi.

## Contardi USA

Contardi Lighting's international growth was solidified in 2015 with the opening of its American subsidiary, Contardi USA, in New York.

This was a crucial step in a market that has always played a key role for the brand and has seen the completion of important projects in the hospitality sector over the years, thanks to Contardi Lighting's ability to develop cutting-edge lighting solutions that fully comply with the highest standards and specific required certifications.

With the opening and presence of the American subsidiary, Contardi ensures a direct presence in one of the world's key locations, responding in real-time to the needs arising from this market.

La crescita internazionale di Contardi Lighting è stata consacrata nel 2015 dall'apertura a New York della filiale americana, la Contardi USA.

Una tappa fondamentale in un mercato che da sempre riveste un ruolo chiave per il brand e che ha visto, nel corso degli anni, la realizzazione di importanti progetti legati al mondo dell'hospitality, grazie alla capacità di Contardi Lighting di sviluppare soluzioni illuminotecniche d'avanguardia, nel pieno rispetto dei più elevati standard e delle certificazioni specifiche richieste.

Con l'apertura e presenza della filiale americana, Contardi garantisce un presidio diretto in uno dei punti nevralgici del mondo rispondendo in tempo reale alle esigenze provenienti da questo mercato.



# designers

**TRISTAN AUER**



An interior designer and "architect of emotions," Tristan Auer creates projects with an original and captivating style that combines avant-garde vision, decorative arts, and craftsmanship. His highly attentive approach to aesthetic value finds its fullest expression in the use of light and color and the juxtaposition of styles from different eras.

Interior designer e architetto delle emozioni, Tristan Auer crea progetti dallo stile originale e accattivante che combinano visione avanguardista, arti decorative e artigianato. Il suo approccio estremamente attento al valore estetico trova la massima espressione nell'uso della luce e del colore e nell'accostamento di stili riconducibili a epoche diverse.

**CHIARA CABERLON**



Chiara Caberlon is an architect and interior designer who has turned the art of creativity into a profession. For her, beauty is a way of life, reflected in attention to detail, harmony, and balance. Her studio, founded in 2004, stands out for its innovation in tailor-made hospitality concepts, combining flexibility and bespoke design.

Chiara Caberlon è un architetto e interior designer che ha trasformato il gioco della creatività in professione. Per lei, il bello è un modo di vivere, riflesso nell'attenzione ai dettagli, nell'armonia e nell'equilibrio. Il suo studio fondato nel 2004 si distingue per l'innovazione nei concept di ospitalità tailor-made unendo flessibilità e sartorialità.

**MARCELLO COLLI**



The ability to skillfully blend tradition and modernity distinguishes the style of designer Marcello Colli. By enhancing natural materials and craftsmanship, his creations express a deep respect for quality and durability. Each product tells a story of mastery and attention to detail, making every environment intimate and authentic.

La capacità di fondere abilmente tradizione e modernità contraddistingue lo stile del designer Marcello Colli. Valorizzando materiali naturali e artigianalità, le sue creazioni esprimono un profondo rispetto per la qualità e la durata nel tempo. Ogni prodotto racconta una storia di maestria e attenzione ai dettagli, rendendo ogni ambiente intimo e autentico.

**DAINELLI STUDIO**



Founded in 2007 by Leonardo and Marzia Dainelli, Dainelli Studio stands out for its continuous aesthetic and formal research, which is embodied in a refined design that pays close attention to the harmony between shapes, colours, and materials. Each of their projects carries with it a deep design culture combined with knowledge of both industrial and artisanal production techniques and processes.

Fondato nel 2007 da Leonardo e Marzia Dainelli, Dainelli Studio si distingue per la continua ricerca estetica e formale che si concretizza in un design ricercato, attento all'armonia tra forme, colori e materiali. Ogni loro progetto, porta con sé una profonda cultura progettuale unita alla conoscenza delle tecniche e dei processi produttivi industriali ed artigianali.

**KING & ROSELLI**



Founded by Jeremy King and Riccardo Roselli, King & Roselli innovates through the meticulous study of the relationship between materials and new technologies, as well as between craftsmanship and industrial production. Their designs emerge as statements of modernity, where contemporary aesthetics and technique converge in surprising forms.

Fondato da Jeremy King e Riccardo Roselli, King & Roselli innova attraverso lo studio meticoloso del rapporto tra materiali e nuove tecnologie, tra abilità artigianali e produzione industriale. I loro design emergono come dichiarazioni di modernità, dove l'estetica contemporanea e la tecnica si incontrano in forme sorprendenti.

**MAURIZIO DI MAURO**



Maurizio Di Mauro adopts an eclectic and versatile approach, focusing on functionality and comfort. The ergonomic shapes of his designs are an expression of dynamism and contemporaneity. Meticulous details and high-quality materials embody his vision, which never loses sight of the importance of well-being.

Maurizio Di Mauro adotta un approccio eclettico e versatile, focalizzandosi su funzionalità e comfort. Le forme ergonomiche dei suoi design sono espressione di dinamismo e contemporaneità. Dettagli curati e materiali di alta qualità esprimono la sua visione, che non perde mai di vista l'importanza del benessere.

**MKV DESIGN**



Founded by Maria Vafiadis, MKV Design is synonymous with luxury and sophistication. Each project reflects an exclusive aesthetic, with meticulous attention to detail and the quality of materials. The studio's creations transform environments into refined and welcoming spaces where luxury meets the art of design.

Fondato da Maria Vafiadis, MKV Design è sinonimo di lusso e raffinatezza. Ogni progetto riflette un'estetica esclusiva, con un'attenzione maniacale ai dettagli e alla qualità dei materiali. Le creazioni dello studio trasformano gli ambienti in spazi accoglienti e ricercati, dove il lusso incontra l'arte del design.

**PAOLA NAVONE / OTTO STUDIO**



Architect, interior designer, art director, Paola Navone is a designer with an eclectic, candid, and dreamlike soul. Her spirit blends the flavors and colours of the southern world with the tastes and forms of the tradition-rich West. From this stems her inexhaustible curiosity for exploring materials, forms, and structures, which today is a defining element of Otto Studio.

Architetto, interior designer, art director, Paola Navone è una progettista dall'anima eclettica, schietta e sognatrice. Nella sua anima convivono sapori e colori del sud del mondo, unite al gusto e alle forme dell'Occidente ricco di tradizioni. Da tutto ciò deriva l'inesauribile curiosità verso la ricerca di materie, forme e strutture, oggi elemento distintivo di Otto Studio.

**FEDERICO PERI**

Interior and product designer Federico Peri is recognized for his elegant touch and natural aesthetic sense, often expressed through subtly integrated historical references. His style emerges from a synergy between the historical and the contemporary. In 2011, he founded his design studio in Milan, which focuses primarily on interior and furniture design.

Interior e product designer, Federico Peri è riconosciuto per il suo tocco elegante e un senso estetico naturale, spesso espresso in riferimenti storici sottilmente integrati. Uno stile che nasce da una sinergia tra storico e contemporaneo. Nel 2011 ha fondato a Milano il suo studio di progettazione che si occupa principalmente di interior e furniture design.

**MASSIMILIANO RAGGI**

Interior and product designer Massimiliano Raggi creates refined and timeless projects through a creative process aimed at achieving a synergy between function, formal research, and stylistic harmony. The clean lines and delicate details of his products are enhanced by the use of high-quality materials, evoking a sense of sophisticated essentiality.

Interior e product designer, Massimiliano Raggi crea progetti raffinati e senza tempo attraverso un processo creativo teso a raggiungere una sinergia tra funzione, ricerca formale e armonia stilistica. Le linee pulite e i dettagli delicati dei suoi prodotti sono valorizzati dall'uso di materiali pregiati, evocando un senso di sofisticata essenzialità.

**SERVOMUTO**

A Milanese studio established in 2010 pursues an ambitious goal: to reinterpret the lampshade in a contemporary and unexpectedly sophisticated manner. Their creations blend classic forms with modern prints and refined fabrics, producing items that impart warmth, character, and Italian style.

Studio milanese che dal 2010 persegue un obiettivo ambizioso: rivisitare il paralume in chiave contemporanea e inaspettatamente sofisticata. Le creazioni che ne derivano uniscono forme classiche con stampe moderne e tessuti ricercati creando prodotti che infondono calore, carattere e stile italiano.

**FRÉDÉRIC SICARD**

Frédéric Sicard stands out for his meticulous approach to design, where every detail is crafted with utmost precision. His creations are noted for their sophisticated versatility, with high-quality materials that convey a sense of harmony and beauty, seamlessly integrating into modern and refined environments.

Frédéric Sicard si distingue per il suo meticoloso approccio al design, dove ogni dettaglio è curato con estrema precisione. Le sue creazioni si distinguono per una sofisticata versatilità, con materiali di alta qualità che trasmettono un senso di armonia e bellezza, inserendosi perfettamente in ambienti moderni e ricercati.

**STUDIOPEPE**

Founded in 2006 in Milan by Arianna Lelli Mami and Chiara Di Pinto, Studiopepe adopts a multidisciplinary approach to design, blending architecture, interior design, product design, and creative direction. Their layered and eclectic style combines poetic vision with design rigor, featuring a strong iconographic identity rooted in experimentation and research.

Fondato nel 2006 a Milano da Arianna Lelli Mami e Chiara Di Pinto, Studiopepe adotta un approccio multidisciplinare nel design, unendo architettura, interior design, product design e direzione creativa. Il loro stile stratificato ed eclettico mescola visione poetica e rigore progettuale, con una forte identità iconografica basata su sperimentazione e ricerca.

**ADAM D. TIHANY**

An internationally renowned designer with 35 years of experience in hospitality design, Adam D. Tihany is known for his bespoke approach, expressed through projects that speak a deeply diverse and fluid language. His work, refined and often revolutionary, stems from a unique and multicultural perspective.

Designer di fama internazionale con 35 anni di esperienza nel settore dell'hospitality design, Adam D. Tihany è noto per il suo approccio sartoriale espresso in progetti che parlano un linguaggio profondamente diversificato e fluido. Il suo lavoro, raffinato e spesso rivoluzionario, scaturisce da uno sguardo originale e multiculturale.

**JAN VAN LIERDE**

Jan Van Lierde is a Belgian designer, entrepreneur, and architect who, thanks to his artistic vision and meticulous attention to detail, has redefined the architectural concept of light. His works, which blend creativity and technique, have laid the groundwork for a humanistic understanding of lighting design for the 21st century.

Jan Van Lierde è un designer, imprenditore e architetto belga che, grazie alla sua visione artistica e un'attenzione meticolosa ai dettagli, ha ridefinito il concetto architettonico della luce. Le sue opere, che integrano creatività e tecnica, hanno gettato le basi per una comprensione umanistica del design della luce per il XXI secolo.



# index \_ indoor

The images are for illustrative purposes only. Our finishes are the result of delicate handcraft processes.

Le immagini sono inserite a solo scopo illustrativo. Le nostre finiture sono il risultato di delicati processi di lavorazione artigianale.

P26	<b>air</b>	☞	P176	<b>emma</b>	☞   ☞ ☞
P32	<b>arcipelago</b>	☞ ☞	P182	<b>flexiled</b>	☞
P38	<b>asia</b>	☞   ☞	P192	<b>fly</b>	☞   ☞
P50	<b>athena</b>	☞	P220	<b>g+t</b>	☞   ☞ ☞ ☞
P56	<b>audrey</b>	☞ ☞ ☞	P234	<b>kiki</b>	☞   ☞
P66	<b>baggy</b>	☞ ☞ ☞	P252	<b>manhattan</b>	
P80	<b>bianca</b>	☞   ☞ ☞	P258	<b>melanocetus</b>	☞
P98	<b>bogotá</b>	☞	P264	<b>mikado</b>	☞
P104	<b>calypso</b>	☞   ☞	P274	<b>ovale</b>	☞ ☞
P120	<b>circus</b>	☞ ☞	P288	<b>solitario</b>	☞ ☞
P128	<b>claretta</b>	☞ ☞	P298	<b>stick</b>	☞   ☞
P136	<b>coco</b>	☞	P314	<b>tenebra</b>	☞
P148	<b>cube</b>	☞	P274	<b>tonda</b>	☞ ☞
P154	<b>discus</b>	☞ ☞	P168	<b>vegas</b>	☞
P168	<b>eclisse</b>	☞			

## ICONE INDOOR / INDOOR ICONS

☞	☞		☞	☞	☞	☞
suspension sospensione	ceiling soffitto	wall parete	floor terra	table tavolo	reading lettura	battery batteria

# visual index \_ by category

## SUSPENSION / SOSPENSIONE



## CEILING / SOFFITTO

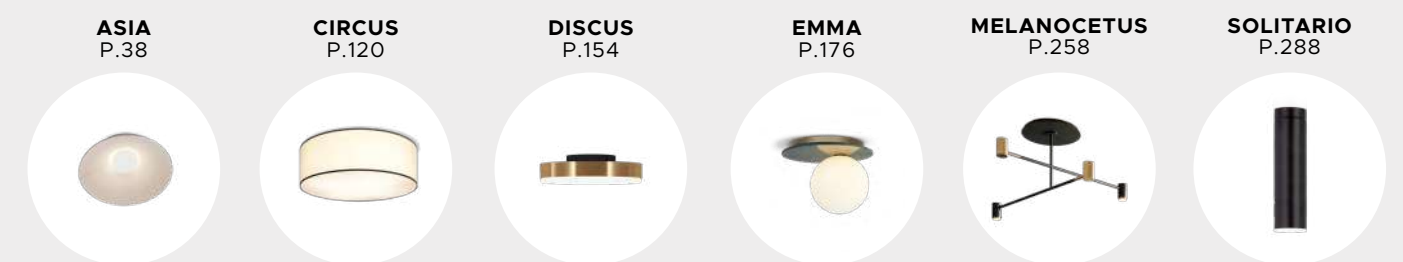

The images are for illustrative purposes only. Our finishes are the result of delicate handcraft processes.  
Le immagini sono inserite a solo scopo illustrativo. Le nostre finiture sono il risultato di delicati processi di lavorazione artigianale.

WALL / PARETE

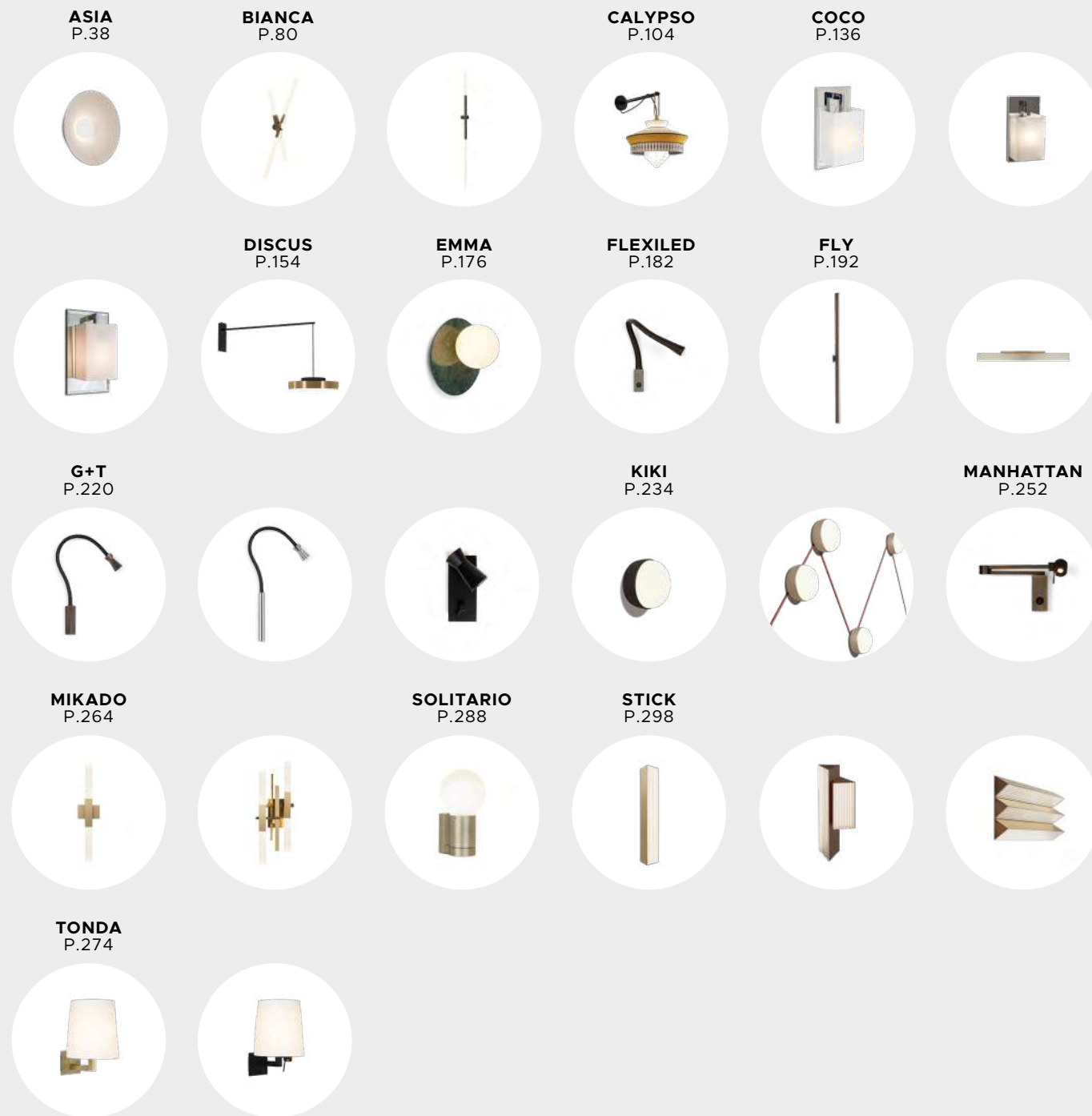

READING / DA LETTURA

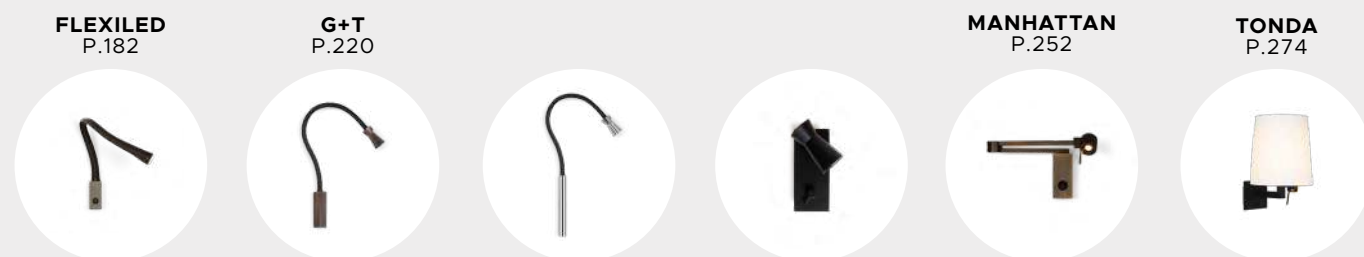
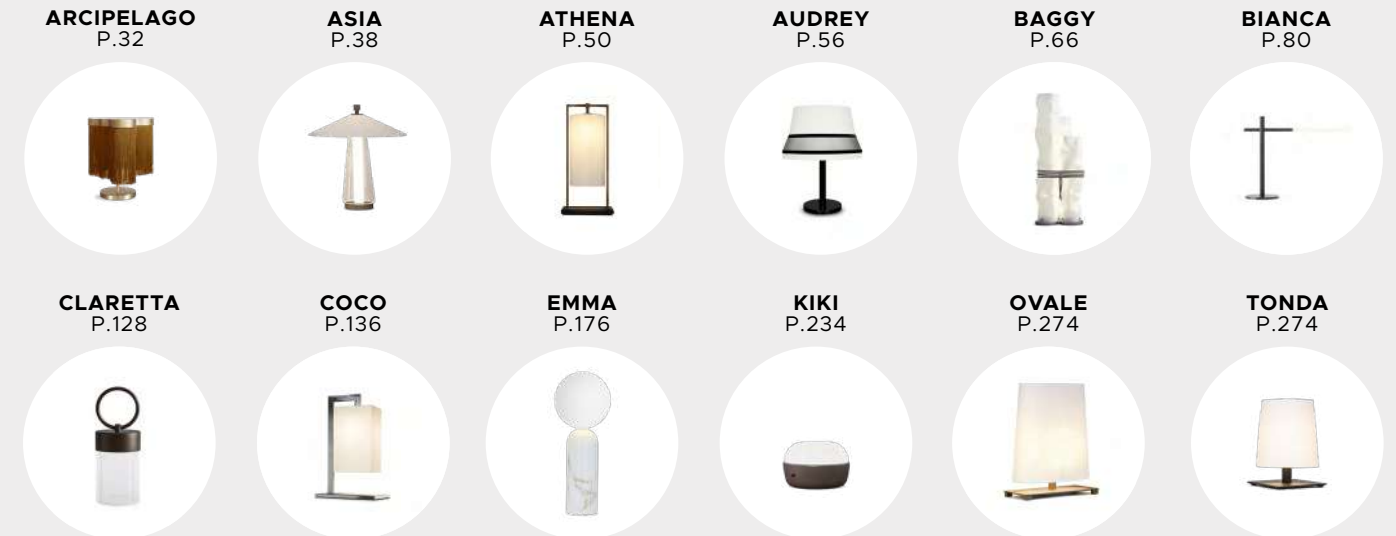

TABLE / TAVOLO



FLOOR / TERRA



BATTERY / BATTERIA



# index \_ outdoor

The images are for illustrative purposes only. Our finishes are the result of delicate handcraft processes.

Le immagini sono inserite a solo scopo illustrativo. Le nostre finiture sono il risultato di delicati processi di lavorazione artigianale.

- P322 **calypso**  
- P332 **clara**   
- P342 **claretta**  
- P350 **cube outdoor**  
- P358 **fly outdoor** 
- P364 **lagoon** 
- P370 **muse**   
- P384 **tenebra** 

## FURNISHING ACCESSORY / COMPLEMENTO D'ARREDO

- P390 **calybabu** 

## OUTDOOR ICONS / ICONE OUTDOOR



# visual index \_ by category

## SUSPENSION / SOSPENSIONE

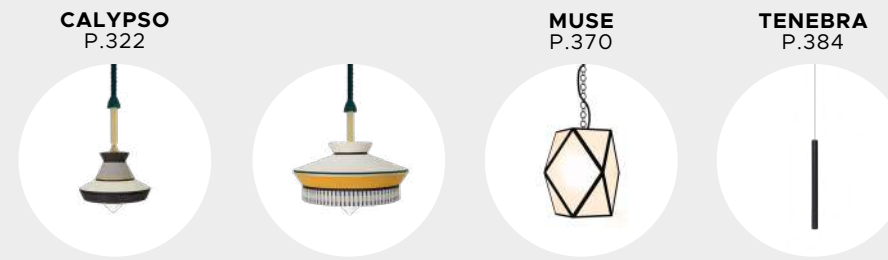

## TABLE / TAVOLO



## FLOOR / TERRA



## BATTERY / BATTERIA



## FURNISHING ACCESSORY / COMPLEMENTO D'ARREDO



The images are for illustrative purposes only. Our finishes are the result of delicate handcraft processes.  
Le immagini sono inserite a solo scopo illustrativo. Le nostre finiture sono il risultato di delicati processi di lavorazione artigianale.

in  
do  
or



# — air

DESIGN ADAM D. TIHANY

Air represents Contardi's sustainable product, made from Green Cast®, a 100% recycled and recyclable material.

The production is free of additives and dyes, ensuring a unique purity. Air's light is directed in a sophisticated way, creating a luminous effect that enhances spaces with elegance while maintaining environmental responsibility.

Air rappresenta il prodotto sostenibile di Contardi, realizzato in Green Cast®, un materiale riciclato e riciclabile al 100%.

La produzione è priva di additivi e coloranti, garantendo una purezza unica. La luce di Air è direzionata in modo sofisticato, creando un effetto luminoso che esalta gli ambienti con eleganza senza tralasciare la responsabilità ambientale.

2

Air suspension lamp, black finish.  
Lampada a sospensione Air, finitura nera.



The shade and diffuser of Air are made of Green Cast® sheets, a 100% recycled and recyclable acrylic material, contributing to making Contardi lighting solutions more sustainable and environmentally friendly.

Il paralume e il diffusore di Air sono realizzati in lastre Green Cast®, un materiale acrilico 100% riciclato e riciclabile, che contribuisce a rendere le soluzioni di illuminazione Contardi più sostenibili e rispettose dell'ambiente.



Air suspension lamp large version, cream finish.  
Lampada a sospensione Air versione large, finitura crema.





# air

IP20

**SUSPENSION / SOSPENSIONE**



**SMALL**

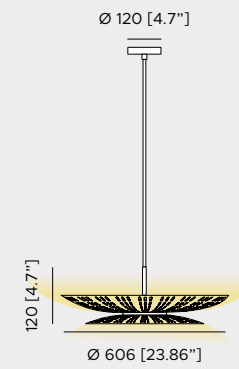

**LARGE**

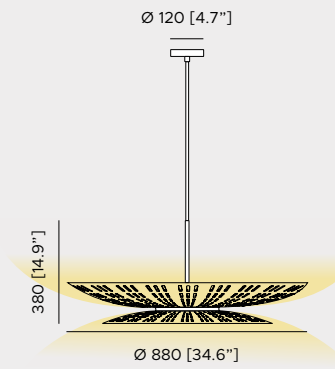

**LIGHT SOURCE / FONTE LUMINOSA**  
double emission / doppia emissione

**220-240V · 110V**  
**SMALL**  
upper emission / emissione superiore 1x3.5 W Strip LED · 450 Lm  
lower emission / emissione inferiore 1x9 W Custom LED · 1.250 Lm  
2.700 K · CRI >90

**LARGE**  
upper emission / emissione superiore 1x7.5 W Strip LED · 650 Lm  
lower emission / emissione inferiore 1x14.3 W Custom LED · 2.450 Lm  
2.700 K · CRI >90

**DIMMING / DIMMERAZIONE**

phase cut (Triac) / taglio di fase (Triac)  
1-10V · DALI on demand / 1-10V · DALI su richiesta

**FINISHES / FINITURE**  
frame / struttura

cream Green Cast®  
 black Green Cast®  
 Green Cast® crema      Green Cast® nero

diffuser / diffusore

opal white  
 bianco opale

**CABLE / CAVO**  
2000mm [79.7"] standard

sand colour fabric  
 tessuto color sabbia

extra cable / cavo extra

up to 5000 mm [196.8"] on demand / fino a 5000 mm [196.8"] su richiesta  
up to 10000 mm [393.7"] on demand / fino a 10000 mm [393.7"] su richiesta





# — arcipelago

DESIGN SERVOMUTO

Arcipelago expresses the refined aesthetic of Servomuto, featuring a satin brass body and flame-retardant fringes. Thanks to its irregular shape, the suspension version can be combined in groups, creating an archipelago of warm light. Its curves allow for harmonious interlocking, perfectly matching enveloping color palettes and making any environment welcoming and sophisticated.

Arcipelago esprime la raffinata estetica di Servomuto, il corpo in ottone satinato e le frange ignifughe. Grazie alla sua forma irregolare, nella versione a sospensione può essere combinata in gruppi creando un arcipelago di luce calda. Le sue curve permettono incastrarsi armoniosi, adattandosi perfettamente a palette cromatiche avvolgenti, rendendo ogni ambiente accogliente e sofisticato.

PH

Arcipelago suspension lamps.  
Lampade a sospensione Arcipelago.



Table lamp with sage green fringes.  
 The fringes of the Arcipelago collection are made of fire-resistant material, crafted by artisans who have historically worked on the most important theaters in the world.  
 Lampada da tavolo con frange verde salvia.  
 Le frange della collezione Arcipelago sono realizzate in materiale ignifugo, create da artigiani che storicamente hanno lavorato nei teatri più importanti del mondo.

Suspension lamps with rust and cognac fringes.  
 Lampade a sospensione con frange color ruggine e cognac.



# arcipelago

IP20



**SUSPENSION / SOSPENSIONE**

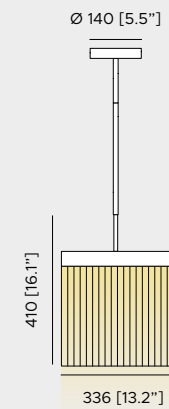

**TABLE / TAVOLO**

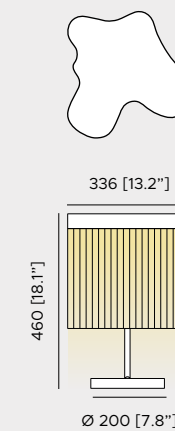

**LIGHT SOURCE / FONTE LUMINOSA**

**220-240V · 110V**  
1x12 W Custom LED · 1.800 Lm  
3000 K · CRI >90

**DIMMING / DIMMERAZIONE**

**TABLE / TAVOLO**  
dimmable / dimmerabile

**SWITCH / INTERRUTTORE**

**TABLE / TAVOLO**  
three intensity levels switch on the base (30% - 70% - 100%) /  
interruttore a tre livelli di intensità sulla base (30% - 70% - 100%)

**FINISHES / FINITURE**

frame / struttura

● satin brass  
ottone satinato

fringes / frange

● sand  
sabbia

● cognac  
cognac

● rust  
ruggine

● sage green  
verde salvia

● fog blue  
blu nebbia

● aragosta  
aragosta

**CABLE / CAVO**

2000mm [79.7"] standard

● black colour fabric  
tessuto color nero

**SUSPENSION / SOSPENSIONE**

extra cable / cavo extra

up to 5000 mm [196.8"] on demand / fino a 5000 mm [196.8"] su richiesta



# — asia

DESIGN FEDERICO PERI

Asia is inspired by the pointed hats of Chinese rice gatherers. Its clean form is enriched by the combination of fabric, glass, and metal.

Available in various sizes, Asia features a 360° light source creating an unexpected and suggestive effect in the table version and a 150° light source in all other versions: suspension, ceiling, and wall.

Asia si ispira ai cappelli a punta dei raccoglitori di riso cinesi. La sua forma pulita è arricchita dall'accostamento materico di tessuto, vetro e metallo.

Disponibile in diverse dimensioni, Asia presenta una sorgente di luce a 360° che crea un effetto inaspettato e suggestivo nella versione da tavolo e una sorgente a 150° in tutte le altre versioni: sospensione, plafone e parete.

— — — —

Asia table lamp, medium size.  
Lampada da tavolo Asia, versione medium.



Wall and table versions of Asia collection.  
Asia nelle versioni a parete e da tavolo.



Detail of Asia suspension lamp.  
Dettaglio di Asia versione sospensione.



Asia suspension in medium e large versions.  
Sospensione Asia nelle versioni medium e large.



Large ceiling version.  
Versione a plafone large.

Small wall version with satin bronze nickel frame  
and double-sided white cotton shade.  
Versione a parete small con struttura bronzo nickel satinato  
e paralume bifacciale in cotone bianco.





# asia

IP20

TABLE / TAVOLO



SMALL

MEDIUM

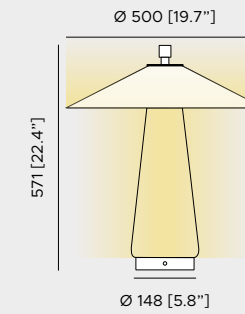
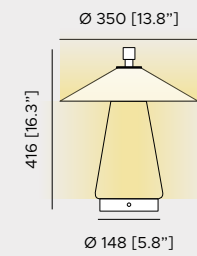

LIGHT SOURCE / FONTE LUMINOSA

220-240V · 110V

**SMALL**  
1x13 W Strip LED · 1.500 Lm  
2.700 K · CRI >90

**MEDIUM**  
1x20 W Strip LED · 2.300 Lm  
2.700 K · CRI >90

DIMMING / DIMMERAZIONE

dimmable / dimmerabile

SWITCH / INTERRUTTORE

push switch on the base / interruttore push sulla base

FINISHES / FINITURE  
frame / struttura

● satin golden nickel  
nickel dorato satinato      ● brushed bronze-nickel  
bronzonickel spazzolato

shade / paralume

● white cotton  
cotone bianco

CABLE / CAVO  
2000mm [79.7\"/>

● black colour fabric  
tessuto color nero



# asia

IP20

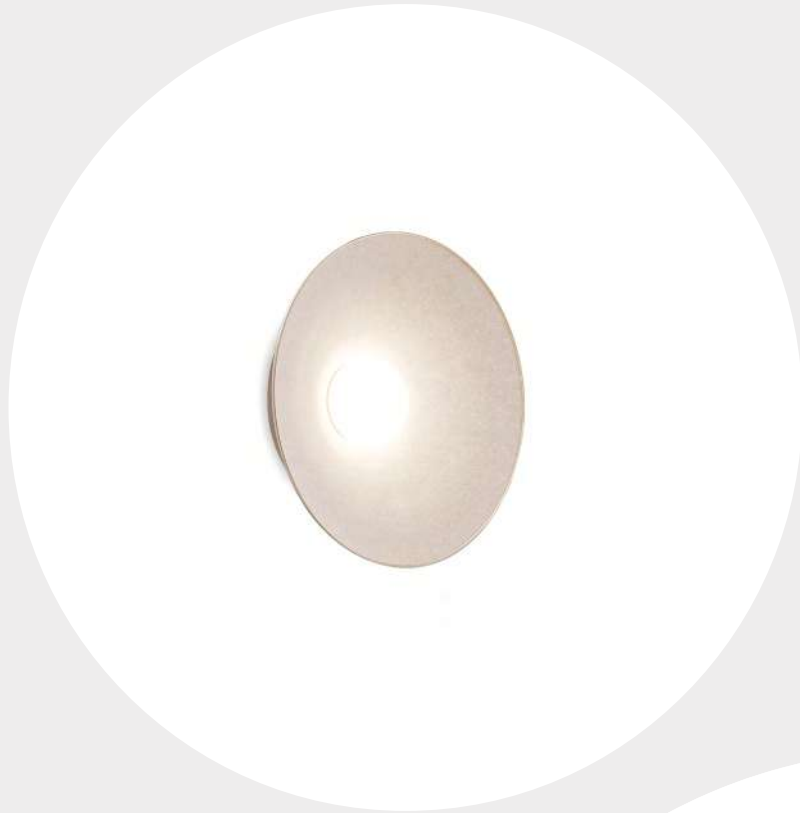

**SUSPENSION / SOSPENSIONE**



**MEDIUM**

**LARGE**

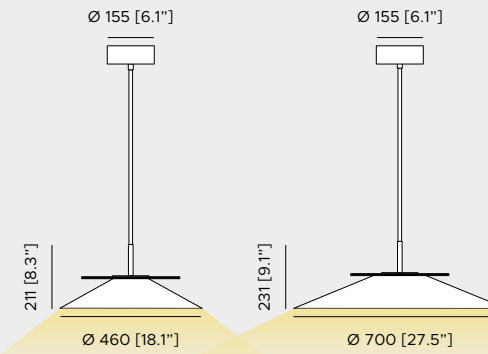

**WALL - CEILING / PARETE - PLAFONE**



**SMALL**

**MEDIUM**

**LARGE**

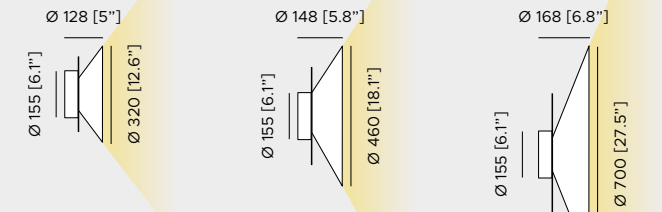

**LIGHT SOURCE / FONTE LUMINOSA**

**220-240V · 110V**

**WALL - CEILING SMALL / PARETE - PLAFONE SMALL**

1x13 W COB LED · 1310 Lm  
2.700 K · CRI >90

**SUSPENSION - WALL - CEILING MEDIUM / PARETE - PLAFONE MEDIUM**

1x19 W COB LED · 1870 Lm  
2.700 K · CRI >90

**SUSPENSION - WALL - CEILING LARGE / PARETE - PLAFONE LARGE**

1x26 W COB LED · 2400 Lm  
2.700 K · CRI >90

**DIMMING / DIMMERAZIONE**

phase cut (Triac) / taglio di fase (Triac)  
1-10V · DALI on demand / 1-10V · DALI su richiesta

**FINISHES / FINITURE**

frame / struttura

● satin golden nickel  
nickel dorato satinato

● brushed bronze-nickel  
bronzonickel spazzolato

shade / paralume

● white cotton  
cotone bianco

**CABLE / CAVO**

2000mm [79.7"] standard

● black colour fabric  
tessuto color nero

**SUSPENSION / SOSPENSIONE**

extra cable / cavo extra

up to 5000 mm [196.8"] on demand / fino a 5000 mm [196.8"] su richiesta  
up to 10000 mm [393.7"] on demand / fino a 10000 mm [393.7"] su richiesta



# — athena

DESIGN MASSIMILIANO RAGGI

In Greek mythology, Athena is the Goddess of knowledge, military strategies, and weaving. It is this last skill that inspired the designer when shaping Athena: rectangles and ovals that merge together, textured fabrics for a couture touch, and a brushed bronze-nickel finish to affirm a sense of balance. Athena serves as a true “passepartout” lamp.

Nella mitologia greca Atena è la Divinità della conoscenza, delle strategie militari e della tessitura. È quest'ultima abilità che ha ispirato il designer quando ha dato forma ad Athena: rettangoli e ovali che si fondono insieme, tessuti materici per un tocco couturier e la finitura bronzo-nickel spazzolato per ribadire un senso di equilibrio. Athena si pone come una vera e propria lampada “passepartout”.

⌈

Athena table lamp.  
Lampada da tavolo Athena.



Athena oval shade detail.  
Dettaglio del paralume ovale di Athena.

Athena in a brushed bronze-nickel finish with a white cotton shade.  
Athena nella finitura bronzo-nickel spazzolato e paralume in cotone bianco.



# athena

IP20

TABLE / TAVOLO

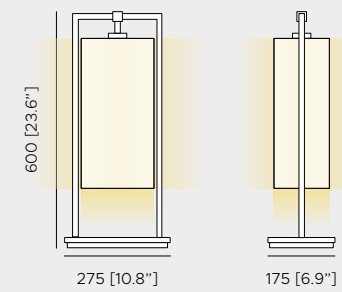

**LIGHT SOURCE / FONTE LUMINOSA**

**220-240V**  
1x13 W E27  
LED light bulb / lampadina LED

**110V**  
1x13 W E26  
LED light bulb / lampadina LED

**DIMMING / DIMMERAZIONE**

dimmer switch on the cable available on demand, compatible with dimmable LED light bulbs only / disponibile su richiesta versione con dimmer su cavo, compatibile solo con lampadine LED dimmerabili

**SWITCH / INTERRUOTTORE**

ON-OFF switch on cable / interruttore ON-OFF su cavo

**FINISHES / FINITURE**  
frame / struttura

● brushed bronze-nickel  
bronzo-nickel spazzolato

base / base

● dark brown stained oak  
rovere tinto marrone scuro

shade / paralume

○ white cotton  
cotone bianco

**CABLE / CAVO**  
2000mm [79.7"] standard

● black colour fabric  
tessuto color nero



# — audrey

DESIGN MASSIMILIANO RAGGI

Audrey is inspired by the elegance of the iconic hat worn by Audrey Hepburn in "Breakfast at Tiffany's". The stem is covered in braided silk, and the lampshade features a Sale & Pepe fabric insert with customizable trims that reinforce the product's strong identity.

Audrey si ispira all'eleganza dell'iconico cappello di Audrey Hepburn in "Colazione da Tiffany". Lo stelo è rivestito in seta intrecciata e il paralume riporta un inserto in tessuto Sale & Pepe con passamanerie personalizzabili che confermano la forte identità del prodotto.

SP

Audrey table lamp, large version.  
Lampada da tavolo Audrey versione large.



Audrey table lamp, medium version.  
Lampada da tavolo Audrey versione medium.



Audrey floor lamp.  
Lampada da terra Audrey.



Detail of Audrey shade in white cotton with Sale & Pepe central band and black cotton trimming.  
Dettaglio paralume Audrey in cotone bianco con fascia centrale Sale & Pepe e passamaneria in cotone nero.



Audrey suspension lamp.  
Lampada a sospensione Audrey.



# audrey

IP20



**TABLE / TAVOLO**



MEDIUM



LARGE

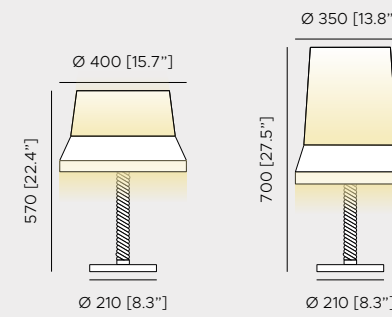

**FLOOR / TERRA**

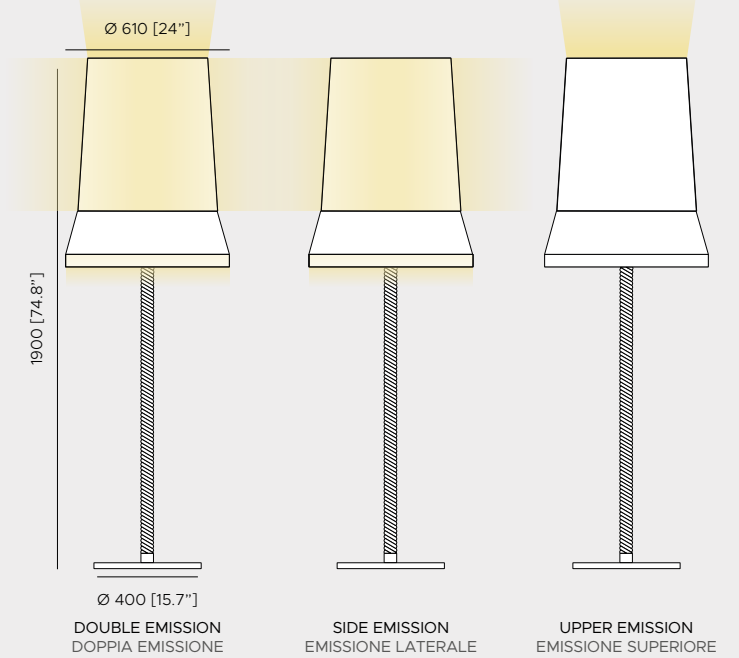

**LIGHT SOURCE / FONTE LUMINOSA**

**220-240V**  
**TABLE / TAVOLO**  
 1x13 W E27  
 LED light bulb / lampadina LED

**110V**  
**TABLE / TAVOLO**  
 1x13 W E26  
 LED light bulb / lampadina LED

**FLOOR / TERRA**  
 3x14 W E27  
 LED light bulbs / lampadine LED

**FLOOR / TERRA**  
 3x14 W E26  
 LED light bulbs / lampadine LED

**DIMMING / DIMMERAZIONE**

**TABLE / TAVOLO**  
 dimmer switch on the cable available on demand, compatible with dimmable LED light bulbs only / disponibile su richiesta versione con dimmer su cavo, compatibile solo con lampadine LED dimmerabili

**SWITCH / INTERRUTTORE**

**TABLE / TAVOLO**  
 ON-OFF switch on cable / interruttore ON-OFF su cavo

**FLOOR / TERRA**  
 double ON-OFF switch on cable, double switching / doppio interruttore ON-OFF su cavo, doppia accensione

**FINISHES / FINITURE**  
 frame / struttura

- glossy black lacquered  
laccato nero lucido
- black braided silk rope stem  
stelo in corda di seta intrecciata nera

shade / paralume

- white cotton  
cotone bianco
- Sale & Pepe band  
fascia Sale & Pepe

trim / passamaneria

- black cotton  
cotone nero

**CABLE / CAVO**  
 2000mm [79.7"] standard

- black colour fabric  
tessuto color nero

# audrey

IP20

**SUSPENSION / SOSPENSIONE**

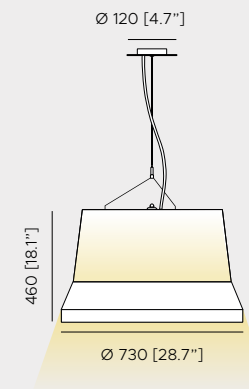

**LIGHT SOURCE / FONTE LUMINOSA**

**220-240V**  
3x14 W E27  
LED light bulbs / lampadine LED

**110V**  
3x14 W E26  
LED light bulbs / lampadine LED

**DIMMING / DIMMERAZIONE**

compatible with remote control systems when dimmable LED bulbs are used / compatibile con sistemi di controllo remoto in caso di utilizzo di lampadine LED dimmerabili

**FINISHES / FINITURE**

frame / struttura

● glossy black lacquered  
laccato nero lucido

shade / paralume

● white cotton  
cotone bianco

● Sale & Pepe band  
fascia Sale & Pepe

trim / passamaneria

● black cotton  
cotone nero

**CABLE / CAVO**

2000mm [79.7"] standard

● black colour fabric  
tessuto color nero

extra cable / cavo extra

up to 5000 mm [196.8"] on demand / fino a 5000 mm [196.8"] su richiesta  
up to 10000 mm [393.7"] on demand / fino a 10000 mm [393.7"] su richiesta



# — baggy

DESIGN PAOLA NAVONE - OTTO STUDIO

Baggy is the most experimental expression of Contardi's decorative style, inspired by the oversized trousers it is named after. With its irregular shape, Baggy challenges the typical precision of the brand, offering a bold design. Each lamp in the collection consists of modules of different sizes, allowing for great compositional freedom. The soft rope adds an unexpected detail, and the 360° light sources make it a functional lighting object.

Baggy è l'espressione più sperimentale del decorativo Contardi, ispirata ai pantaloni oversize da cui prende il nome. Con la sua forma irregolare, Baggy sfida la precisione tipica del brand, proponendo un design audace. Ogni lampada della collezione è composta da moduli di diverse dimensioni, permettendo una grande libertà compositiva. La morbida corda aggiunge un dettaglio inaspettato e le sorgenti luminose a 360° ne fanno un oggetto dall'illuminazione funzionale.

h  
p  
p

Baggy vertical h.90 and horizontal l.90 suspension lamps.  
Lampade a sospensione Baggy verticale h.90 e orizzontale l.90.



Baggy suspension lamps, horizontal version.  
Lampade a sospensioni Baggy, versione orizzontale.



The LED strips inside Baggy ensure an even and consistent illumination across the entire diffuser.

Le strisce LED all'interno di Baggy garantiscono un'illuminazione omogenea e uniforme su tutta l'estensione del diffusore.



Baggy suspension lamp 1800 mm [70.8"]  
and Baggy floor trio version.  
Lampada a sospensione Baggy 1800 mm  
[70.8"] e Baggy piantana trio.



Small and medium version of Baggy table lamps.  
Lampade da tavolo Baggy versioni small e medium.



Baggy table lamp, trio version.  
Lampada da tavolo Baggy, versione trio.



Customizable knot detail for the table and floor lamp versions.  
Dettaglio del nodo personalizzabile nelle versioni tavolo e piantana.



Baggy floor lamp trio.  
Lampada da terra Baggy trio.

# baggy

IP20



**SUSPENSION / SOSPENSIONE**



**VERTICAL H.60 / 90**

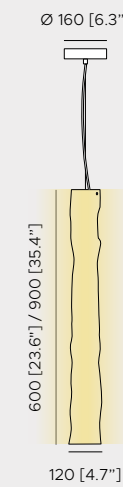

**HORIZONTAL L.60 / 90**

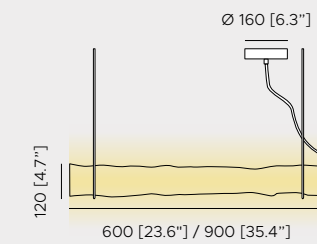

**HORIZONTAL L.180**

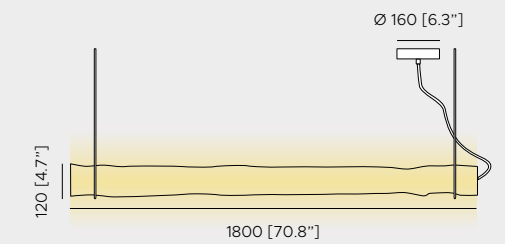

**LIGHT SOURCE / FONTE LUMINOSA**

**220-240V · 110V**

**VERTICAL H.60 - HORIZONTAL L.60 / VERTICALE H.60 - ORIZZONTALE L.60**  
1x16.2 W Custom strip LED · 2356 Lm  
3000 K · CRI >90

**VERTICAL H.90 - HORIZONTAL L.90 / VERTICALE H.90 - ORIZZONTALE L.90**  
1x25.2 W Custom strip LED · 3625 Lm  
3000 K · CRI >90

**HORIZONTAL L.180 / ORIZZONTALE L.180**  
1x52 W Custom strip LED · 7431 Lm  
3000 K · CRI >90

**DIMMING / DIMMERAZIONE**

phase cut (Triac) / taglio di fase (Triac)  
1-10V · DALI on demand / 1-10V · DALI su richiesta

**FINISHES / FINITURE**

canopy / rosone

 matt white lacquered  
laccato bianco opaco

diffuser / diffusore

 dual satin polycarbonate  
policarbonato bisatinato

**ROPE · CABLE / CORDA · CAVO**  
2000mm [79.7"] standard

 white/grey colour fabric  
corda tessuto color bianco/grigio

 transparent steel  
acciaio trasparente

extra cable / cavo extra

up to 5000 mm [196.8"] on demand / fino a 5000 mm [196.8"] su richiesta  
up to 10000 mm [393.7"] on demand / fino a 10000 mm [393.7"] su richiesta



# baggy

IP20



**TABLE / TAVOLO**



**SMALL**

**MEDIUM**



**TRIO**

**FLOOR / TERRA**



**TRIO**

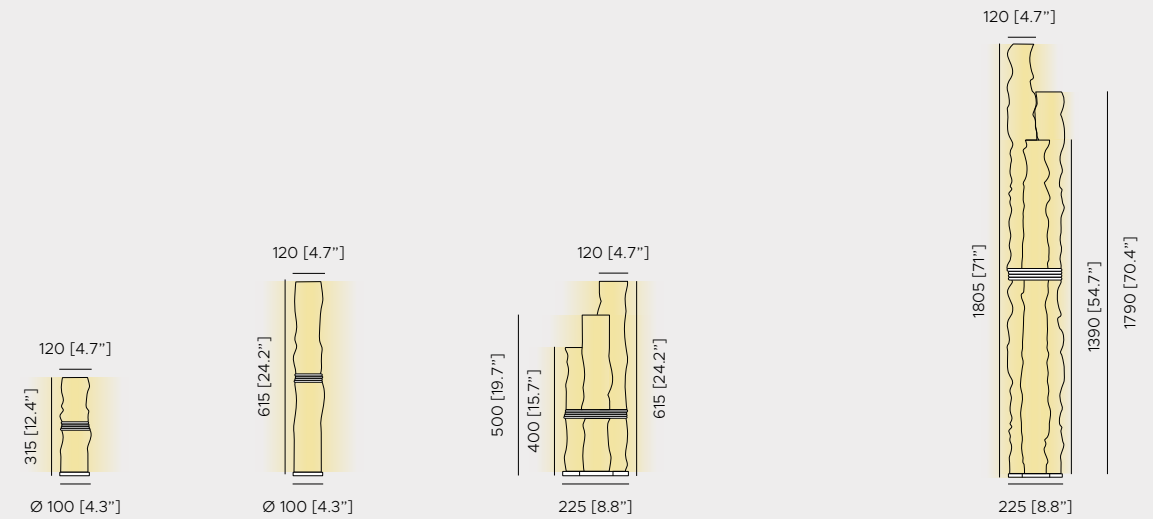

**LIGHT SOURCE / FONTE LUMINOSA**

**220-240V · 110V**

**SMALL**  
1x7.6 W Custom strip LED · 1080 Lm  
3000 K · CRI >90

**MEDIUM**  
1x16.2 W Custom strip LED · 2356 Lm  
3000 K · CRI >90

**TABLE TRIO / TAVOLO TRIO**  
1x11.4 W + 1x8.8 W + 1x7 W Custom strip LED · 3933 Lm tot.  
3000 K · CRI >90

**FLOOR TRIO / TERRA TRIO**  
1x35.9 W + 1x31.5 W + 1x29.7 W Custom strip LED · 14084 Lm tot.  
3000 K · CRI >90

**DIMMING / DIMMERAZIONE**

dimmable / dimmerabile

**SWITCH / INTERRUTTORE**

**TABLE / TAVOLO**  
switch on cable / interruttore su cavo

**FLOOR / TERRA**  
foot control / interruttore a piede

**FINISHES / FINITURE**

frame / struttura

● grey lacquered base  
base laccato grigio

diffuser / diffusore

● dual satin polycarbonate  
polycarbonato bisatinato

**CABLE / CAVO**  
2000mm [79.7"] standard

● black colour fabric  
tessuto color nero

**ACCESSORIES / ACCESSORI**

● white/grey colour fabric  
corda tessuto color bianco/grigio



# — bianca

DESIGN DAINELLI STUDIO

Bianca is inspired by the symmetrical beam structure typical of snowflakes, rendered through luminous arms in a matt brass or matt black silk lacquered finish. The lamp is composed of modules within the structure that, when connected, shape the different variations of the family.

The connection of the lamp is not via wires but by contact.

Each module consists of two printed circuits that, in contact with those in the other modules, allow electricity to run through and illuminate the lamp. The tubular light sources are the bulbs themselves in three different sizes, made exclusively by Contardi with a low-voltage E14 socket (24V).

Bianca si ispira alla struttura ad assi simmetrici tipica dei fiocchi di neve, resa attraverso bracci luminosi nella finitura ottone opaco o laccato nero seta opaco. La lampada è composta da moduli all'interno della struttura che, collegati uno con l'altro, danno forma alle diverse declinazioni della famiglia.

Il collegamento della lampada non avviene tramite fili, ma per contatto.

Ogni singolo modulo è composto da due circuiti stampati che, a contatto con quelli presenti negli altri moduli, permettono di portare l'elettricità per illuminare la lampada. Le sorgenti luminose tubolari sono le lampadine stesse in tre diverse dimensioni, fatte realizzare appositamente da Contardi, con attacco E14 a bassissima tensione (24V).

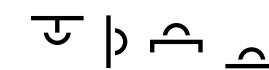

Bianca Double, suspension lamp, matt black silk lacquered finish.  
Lampada a sospensione Bianca Double, finitura laccato nero seta opaco.



Bianca Double, suspension lamp,  
brass finish.

Lampada a sospensione Bianca Double,  
finitura ottone.

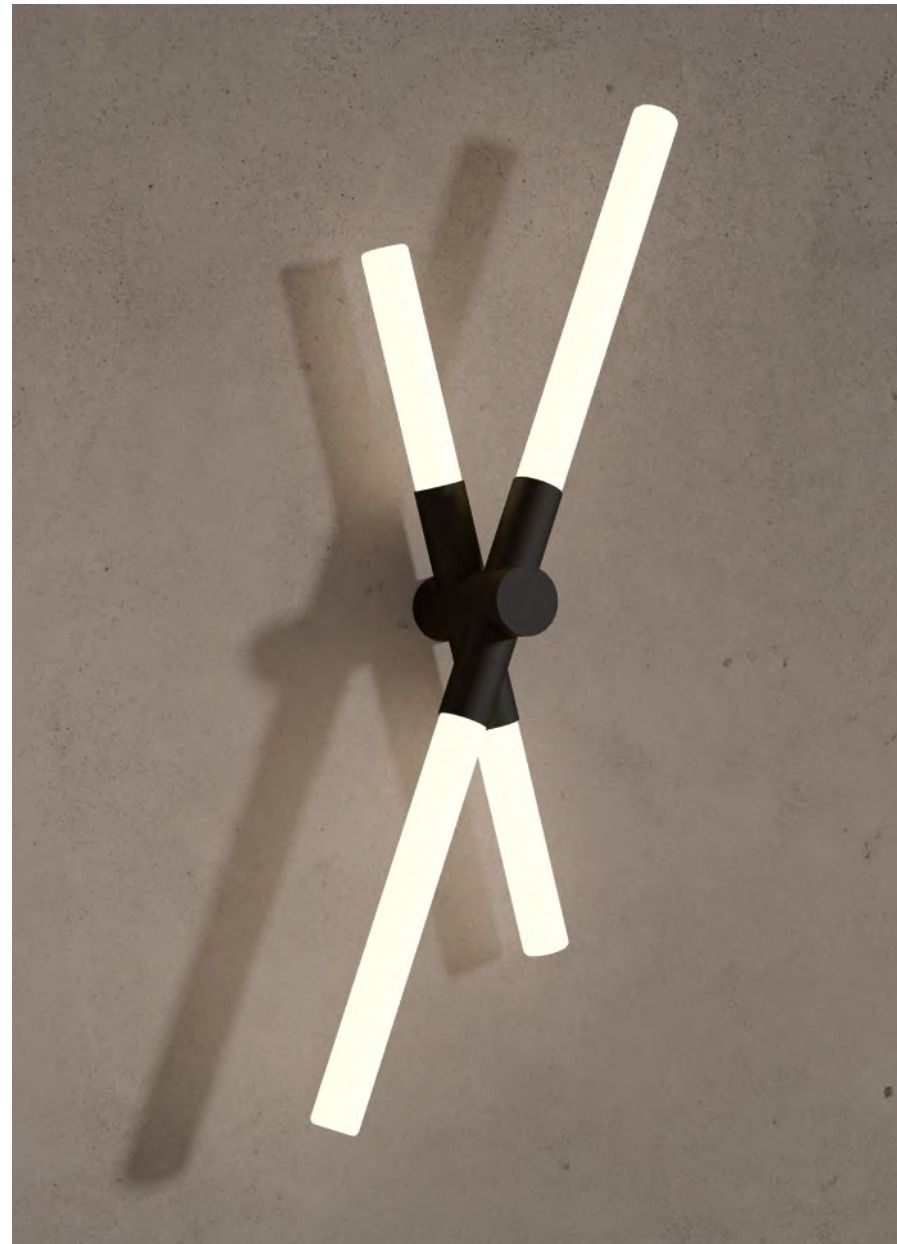

Bianca wall, version with remote driver, matt black silk lacquered finish.  
Lampada da parete Bianca, con driver remoto, finitura laccato nero seta opaco.

Bianca wall light, linear version with remote driver, brass finish.  
Lampada da parete Bianca, versione linear con driver remoto, finitura ottone.

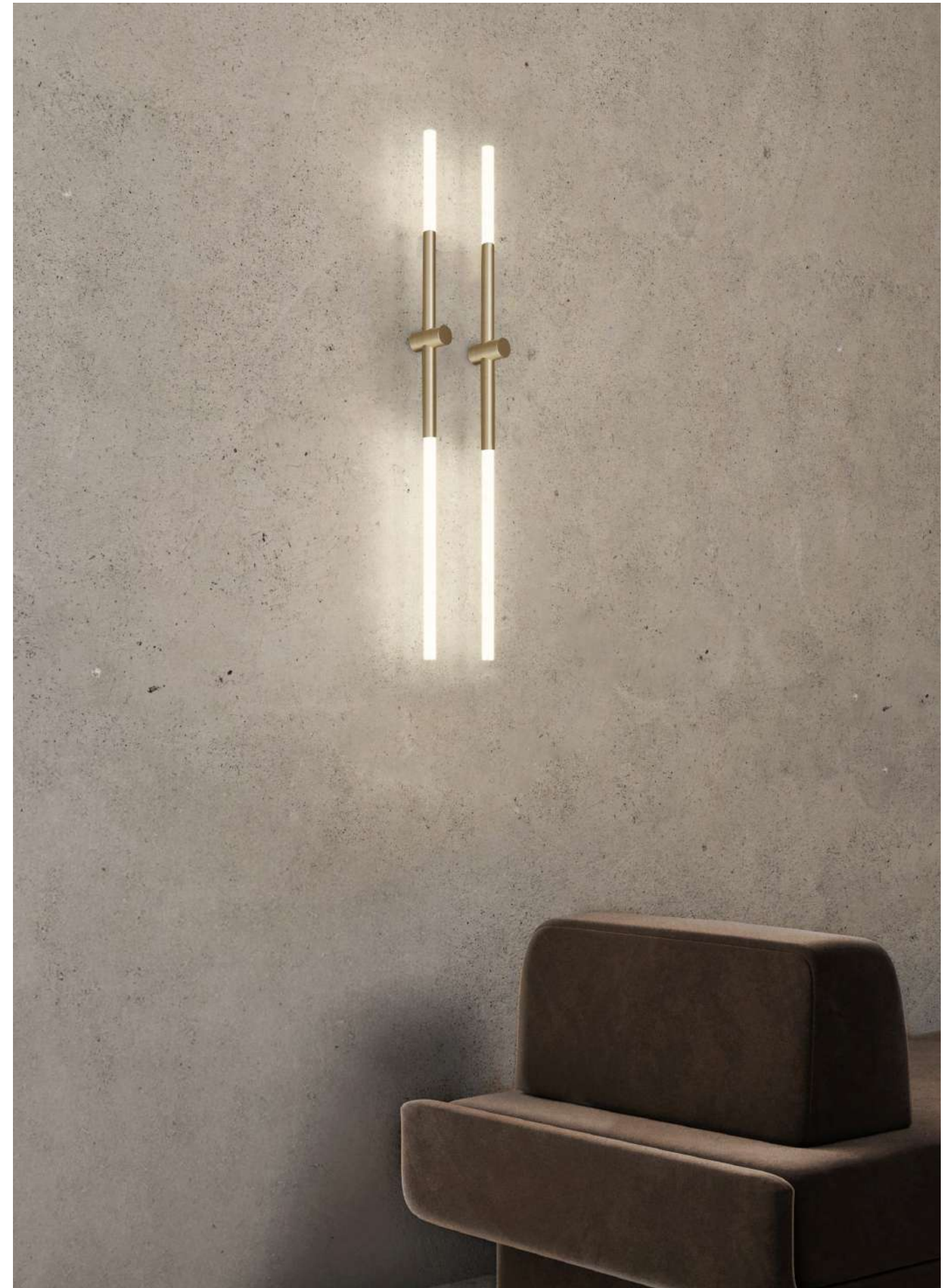



Bianca table lamp, brass finish.  
Lampada da tavolo Bianca, finitura in ottone.



Bianca Liseuse, matt black silk lacquered finish.  
Lampada da terra Bianca, finitura laccato nero seta opaco.

# bianca

IP20

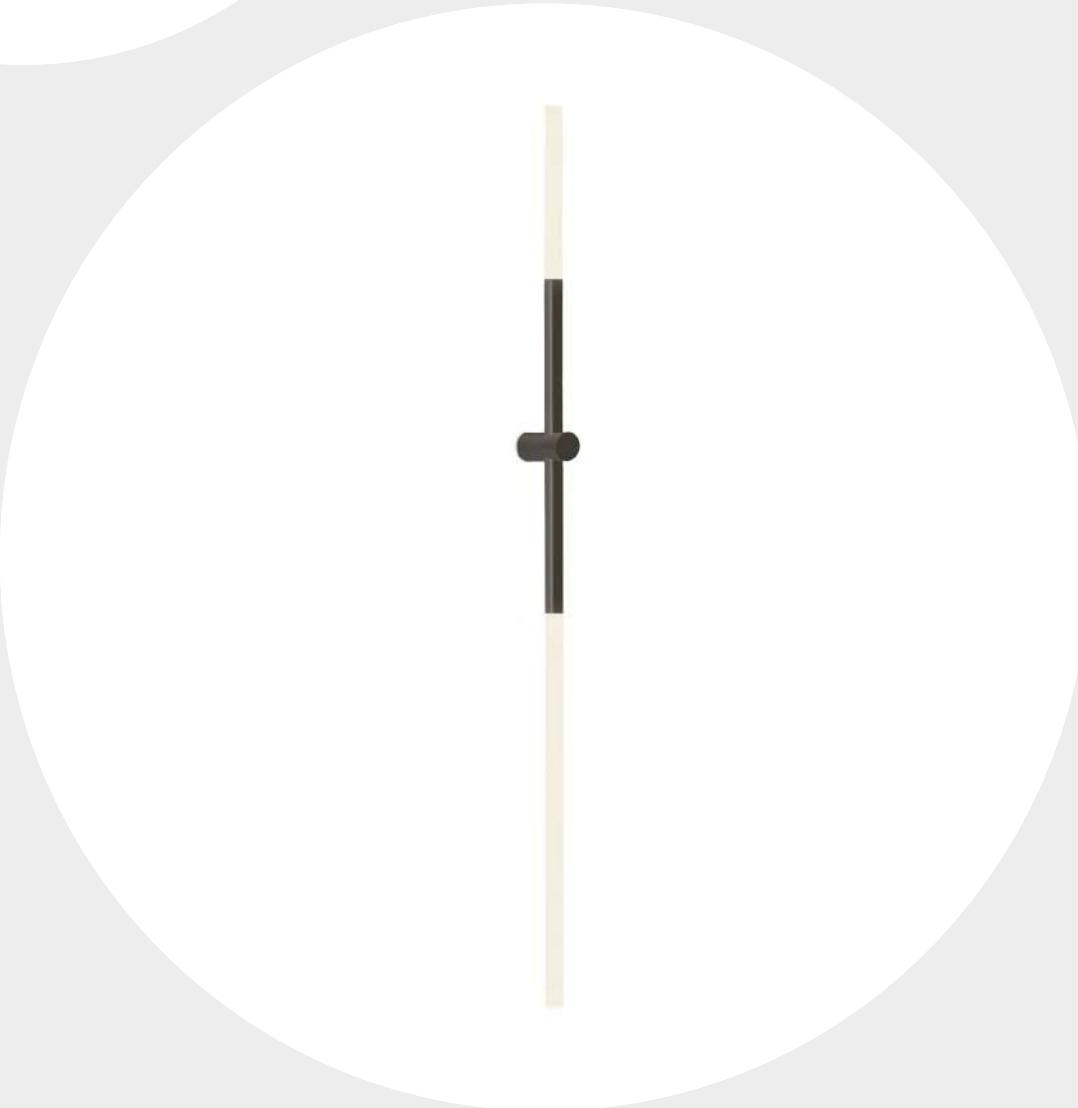

## WALL / PARETE



### WALL

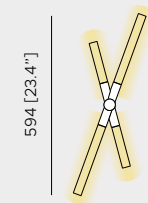

WITHOUT BASE  
(REMOTE DRIVER) /  
SENZA BASETTA  
(DRIVER REMOTO)

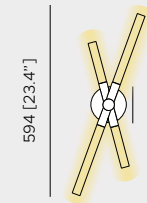

WITH DRIVER  
IN THE BASE /  
CON DRIVER  
NELLA BASETTA



### LINEAR



WITHOUT BASE  
(REMOTE DRIVER) /  
SENZA BASETTA  
(DRIVER REMOTO)

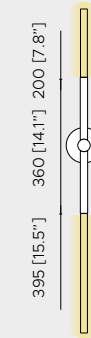

WITH DRIVER  
IN THE BASE /  
CON DRIVER  
NELLA BASETTA

## INCLUDED BULBS / LAMPADINE INCLUSE

### WALL



2 X SMALL



2 X MEDIUM

### LINEAR



1 X MEDIUM



1 X LARGE

## LIGHT SOURCE / FONTE LUMINOSA

### 220-240V · 110V

**WALL / PARETE**  
2x4.4 W + 2x5.6 W Custom LED bulbs · 1680 Lm tot.  
3000 K · CRI >90

### LINEAR

1x5.6 W + 1x9.1 W Custom LED bulbs · 1390 Lm tot.  
3000 K · CRI >90

## DIMMING / DIMMERAZIONE

phase cut (Triac) / taglio di fase (Triac)  
1-10V · DALI on demand / 1-10V · DALI su richiesta

## FINISHES / FINITURE

frame / struttura

 brass  
ottone

 matt black silk lacquered  
laccato nero seta opaco

diffuser / diffusore

 milky white glass  
vetro bianco latte

# bianca

IP20



**SUSPENSION / SOSPENSIONE**



**SUSPENSION**

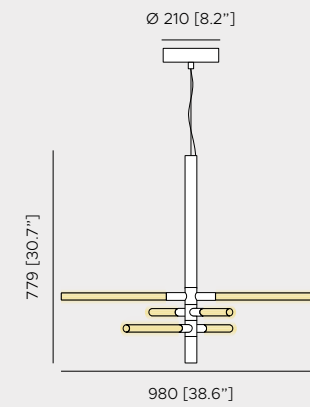

**DOUBLE SUSPENSION**

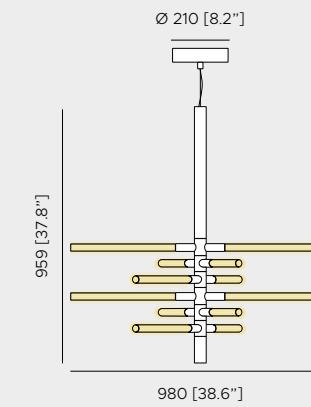

**INCLUDED BULBS / LAMPADINE INCLUSE**

**SUSPENSION**

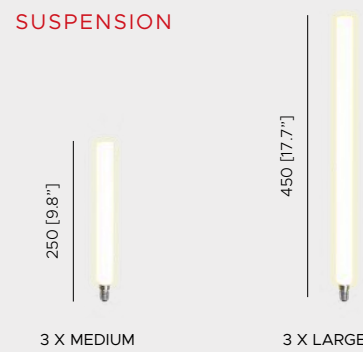

**DOUBLE SUSPENSION**



**LIGHT SOURCE / FONTE LUMINOSA**

**220-240V · 110V**

**SUSPENSION / SOSPENSIONE**

3x5.6 W + 3x9.1 W Custom LED bulbs · 4170 Lm tot.  
3000 K · CRI >90

**DOUBLE SUSPENSION / SOSPENSIONE DOPPIA**

6x5.6 W + 6x9.1 W Custom LED bulbs · 8340 Lm tot.  
3000 K · CRI >90

**DIMMING / DIMMERAZIONE**

phase cut (Triac) / taglio di fase (Triac)  
1-10V · DALI on demand / 1-10V · DALI su richiesta

**FINISHES / FINITURE**  
frame / struttura

● brass  
ottone

● matt black silk lacquered  
laccato nero seta opaco

diffuser / diffusore

● milky white glass  
vetro bianco latte

**ROPE · CABLE / CORDA · CAVO**  
2000mm [79.7"] standard

● black colour fabric  
tessuto color nero

extra cable / cavo extra

up to 5000 mm [196.8"] on demand / fino a 5000 mm [196.8"] su richiesta  
up to 10000 mm [393.7"] on demand / fino a 10000 mm [393.7"] su richiesta



# bianca

IP20

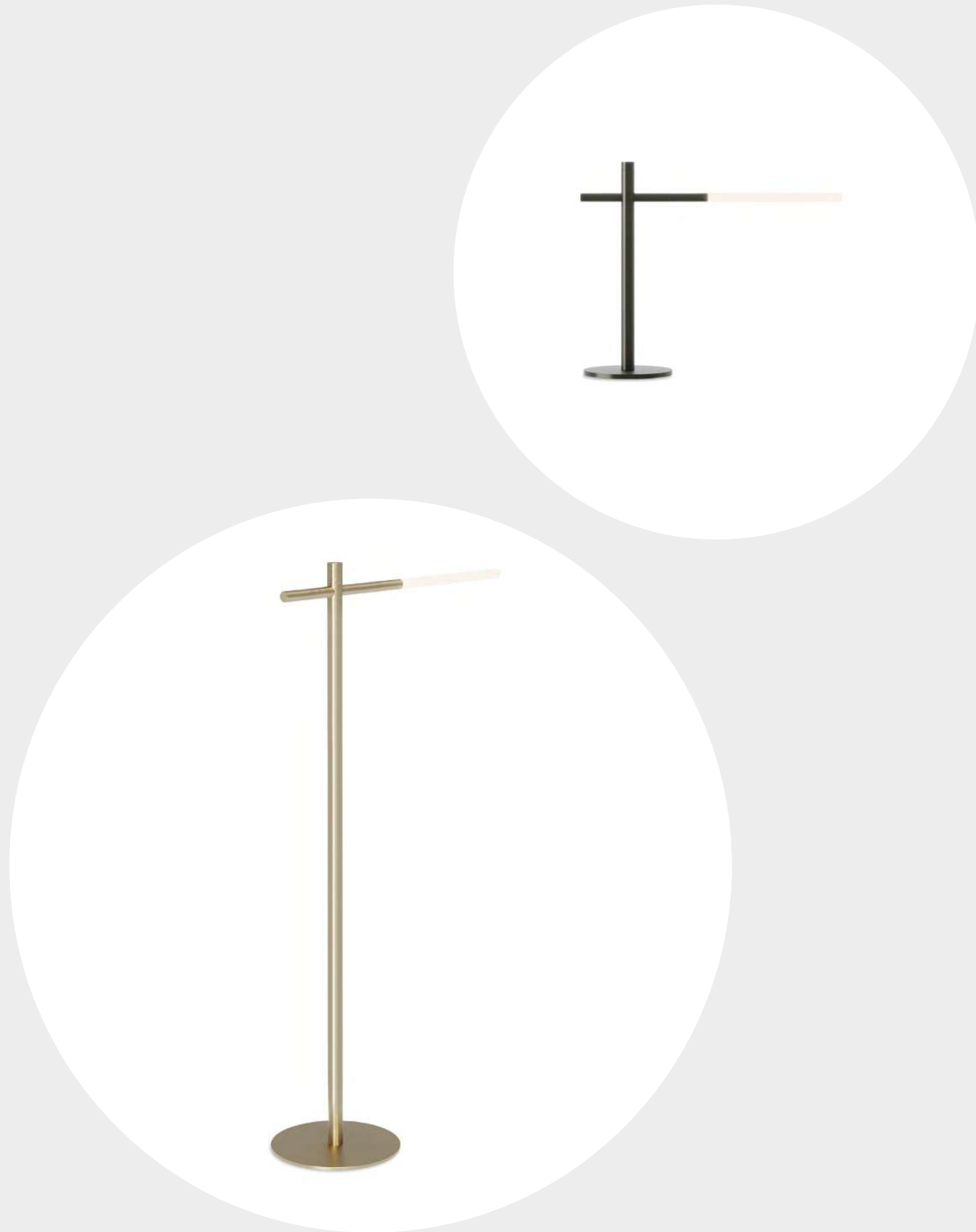

**TABLE / TAVOLO**

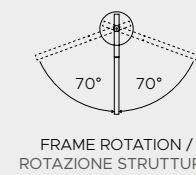
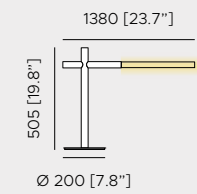

**LISEUSE / LISEUSE**

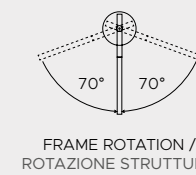
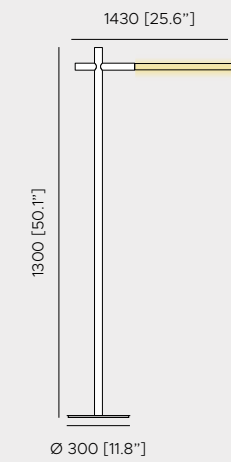

**INCLUDED BULBS / LAMPADINE INCLUSE**

**TABLE**



**LISEUSE**



**LIGHT SOURCE / FONTE LUMINOSA**

**220-240V · 110V**  
**TABLE / TAVOLO**  
 1x5.6 W Custom LED bulbs · 490 Lm  
 3000 K · CRI >90

**LISEUSE**  
 1x9.1 W Custom LED bulbs · 900 Lm  
 3000 K · CRI >90

**DIMMING / DIMMERAZIONE**

dimmable / dimmerabile

**SWITCH / INTERRUTTORE**

touch botton on the head of the vertical stem / interruttore sulla testa della struttura verticale

**FINISHES / FINITURE**  
 frame / struttura

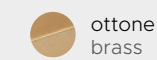

ottone  
brass

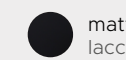

matt black silk lacquered  
laccato nero seta opaco

diffuser / diffusore



milky white glass  
vetro bianco latte

**CABLE / CAVO**  
 2000mm [79.7\"/>

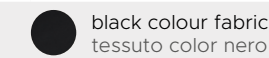

black colour fabric  
tessuto color nero

# modified stock



The lamp consists of modules that connect wirelessly through contact points. Each module contains two printed circuits that transfer electricity to the others, illuminating the lamp. The tubular light sources, available in three sizes, are custom-made by Contardi with an E14 24V fitting.

La lampada è composta da moduli collegati senza fili tramite contatto. Ogni modulo ha due circuiti stampati che trasmettono elettricità agli altri, illuminando la lampada.

Le sorgenti luminose, in tre dimensioni, sono lampadine tubolari E14 a 24V, realizzate su misura da Contardi.

## BIANCA CUSTOMIZATION / PERSONALIZZAZIONE DI BIANCA

SMALL

MEDIUM

LARGE

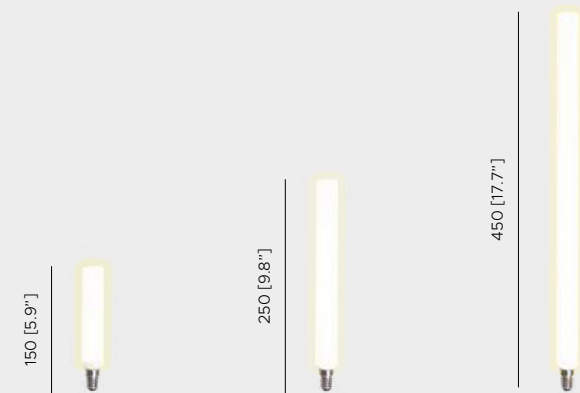

Possibility to add multiples of three modules. The individual modules can be combined to create a customized product layout.  
Possibilità di aggiungere multipli di tre moduli. I singoli moduli si possono combinare per creare uno schema del prodotto personalizzato.

Tubular light sources E14 24V, available in three sizes: small, medium and large.

Lampadine tubolari E14 a 24V, disponibili in tre dimensioni: small, medium e large.

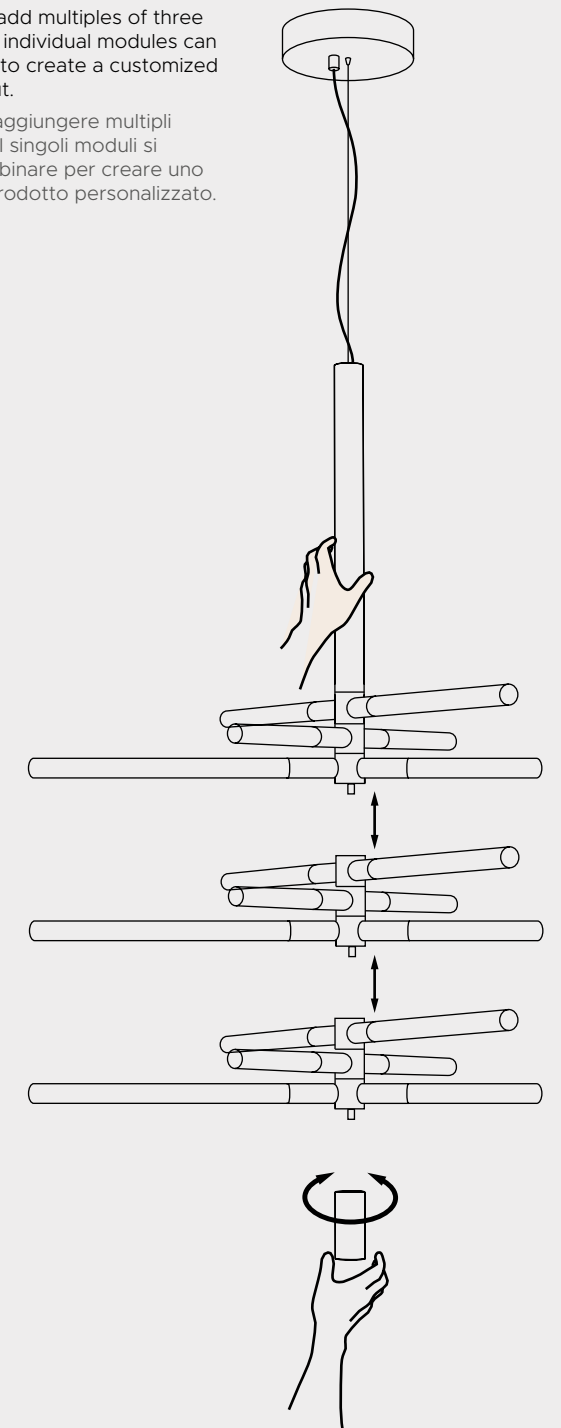



# — bogotà

DESIGN MASSIMILIANO RAGGI

Bogotà reinterprets suspended rings with contemporary elegance. This “flat” lamp becomes a closed ring with LED Panel technology that illuminates the edges, intersecting to the center. The light is shielded by textile diffusers, recalling Contardi’s distinctive use of fabrics. Light and fluid, Bogotà appears to be suspended in the air, combining modernity and vintage style.

Bogotà reinterpreta gli anelli sospesi con eleganza contemporanea. Questa lampada “flat” diventa un anello chiuso con tecnologia del Panel LED che illumina i bordi, intersecandosi fino al centro. La luce è schermata da diffusori tessili, richiamando l’uso distintivo dei tessuti di Contardi. Leggera e fluida, Bogotà sembra sospesa in aria, combinando modernità e stile vintage.

Bogotà suspension version, black stained wooden ring, white cotton diffuser.  
Lampada a sospensione Bogotà, anello in legno tinto nero, diffusore cotone bianco.

h



Bogotá suspension version, black stained wooden ring, white Calacatta marble printed fabric diffuser.

Lampada a sospensione Bogotá, anello in legno tinto nero, diffusore tessuto stampato effetto marmo bianco Calacatta.

# bogotà

IP20



**SUSPENSION / SOSPENSIONE**



**SMALL**

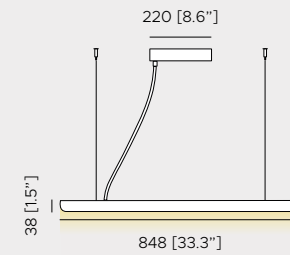

**LARGE**

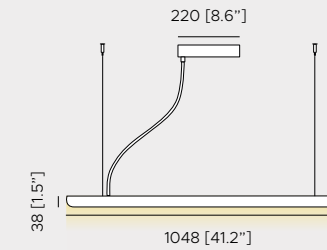

**LIGHT SOURCE / FONTE LUMINOSA**

**220-240V · 110V**

**SMALL**  
1x39 W Panel LED · 3100 Lm  
3000 K · CRI >90

**LARGE**  
1x43 W Panel LED · 4100 Lm  
3000 K · CRI >90

**DIMMING / DIMMERAZIONE**

phase cut (Triac) / taglio di fase (Triac)  
1-10V · DALI on demand / 1-10V · DALI su richiesta

**FINISHES / FINITURE**

frame / struttura

 black stained wooden ring  
anello in legno tinto nero

diffuser / diffusore

 white cotton  
cotone bianco

 white Calacatta marble printed fabric  
tessuto stampato effetto marmo bianco Calacatta

canopy / rosone

 white lacquered  
laccato bianco

**CABLE / CAVO**

2000mm [79.7"] standard

 transparent steel  
acciaio trasparente

extra cable / cavo extra

up to 5000 mm [196.8"] on demand / fino a 5000 mm [196.8"] su richiesta  
up to 10000 mm [393.7"] on demand / fino a 10000 mm [393.7"] su richiesta



# — calypso

DESIGN SERVOMUTO

Calypso, inspired by art deco, represents the pinnacle of Contardi's textile expression. Available as a suspension, floor, or wall lamp, it combines a waltz of colours and materials: precious fabrics, braided silk rope, metal, and glass. The black-and-white geometric patterns blend with bright colours inspired by South American and tropical cultures, creating a surprising and original visual impact.

Calypso, ispirata all'art déco, rappresenta la massima espressione tessile di Contardi. Questa lampada, disponibile a sospensione, a terra e a parete, combina un walzer di colori e materiali: tessuti pregiati, corda intrecciata in seta, metallo e vetro. I motivi geometrici in bianco e nero si mescolano a colori accesi ispirati alla cultura sudamericana e tropicale, creando un impatto visivo sorprendente e originale.

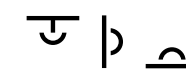

Calypso suspension lamps.  
Lampade a sospensione Calypso.



Calypso suspension and suspension XL cluster and floor lamp with table.  
Sospensioni e sospensioni XL nel cluster Calypso e lampada da terra con tavolino.



Detail of the brass ring and the option to create knots with the green silk cord of the Calypso pendant lamp, so to shorten the length.  
Dettaglio dell'anello in ottone e possibilità di anodare il cordone in seta verde di Calypso sospensione, per accorciare la lunghezza del cavo.

Calypso and Calypso XL suspension cluster.  
Cluster lampade a sospensione Calypso e Calypso XL.







Calypso wall light, Martinique yellow version.  
Lampada a parete Calypso, versione Martinique yellow.



Detail of the Calypso floor lamp stem: green leather, brass detail, and matt black silk lacquered stem.

Dettaglio dello stelo della piantana Calypso:  
pelle verde, dettaglio in ottone e stelo laccato nero seta opaco.

Calypso floor lamp with green Guatemala marble table.  
Lampada da terra Calypso con tavolino in marmo verde Guatemala.



# calypso

IP20



**SUSPENSION / SOSPENSIONE**



**ANTIGUA**

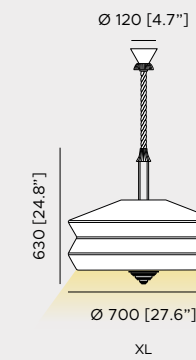
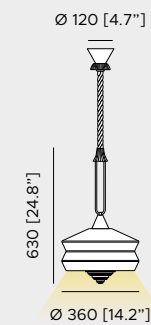

**GUADALOUPE**

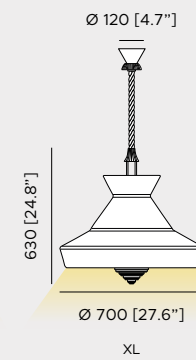
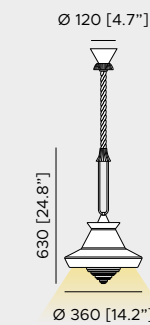

**MARTINIQUE**

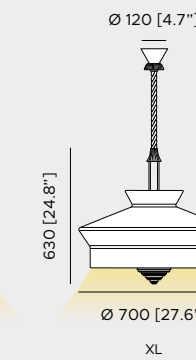
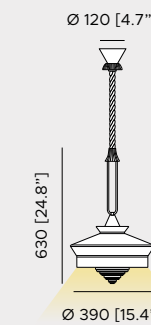

**LIGHT SOURCE / FONTE LUMINOSA**

**220-240V**  
**SUSPENSION / SOSPENSIONE**  
 1x14 W E27  
 LED light bulb / Lampadina LED

**110V**  
**SUSPENSION / SOSPENSIONE**  
 1x14 W E26  
 LED light bulb / Lampadina LED

**DIMMING / DIMMERAZIONE**

compatible with remote control system when dimmable LED bulbs are used /  
 compatibile con sistemi di controllo remoto con lampadine LED dimmerabili

**FINISHES / FINITURE**  
 frame / struttura

 satin brass  
 ottone satinato

shade / paralume  
**CALYPSO - CALYPSO XL**



**CALYPSO**

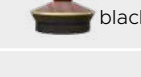
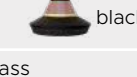
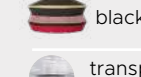
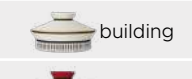
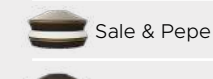

diffuser / diffusor

 transparent glass  
 vetro trasparente

**ROPE · CABLE / CORDA · CAVO**  
 2000mm [79.7"] standard

 moss green braided silk  
 seta intrecciata verde muschio

extra rope · cable / cavo · cavo extra

up to 5000 mm [196.8"] on demand / fino a 5000 mm [196.8"] su richiesta  
 up to 10000 mm [393.7"] on demand / fino a 10000 mm [393.7"] su richiesta

# calypso

IP20



**WALL / PARETE**



**ANTIGUA**

**GUADALOUPE**

**MARTINIQUE**

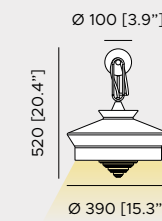
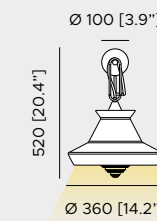
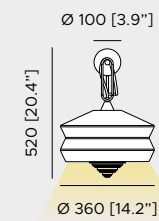

**LIGHT SOURCE / FONTE LUMINOSA**

**220-240V**  
**WALL / PARETE**  
 1x14 W E27  
 LED light bulb / Lampadina LED

**110V**  
**WALL / PARETE**  
 1x14 W E26  
 LED light bulb / Lampadina LED

**DIMMING / DIMMERAZIONE**

compatible with remote control system when dimmable LED bulbs are used /  
 compatibile con sistemi di controllo remoto con lampadine LED dimmerabili

**FINISHES / FINITURE**  
 frame / struttura

matt black silk lacquered  
 laccato nero seta opaco

satin brass ring  
 anello ottone satinato

shade / paralume

**ANTIGUA**

mint

**GUADALOUPE**

Sale & Pepe

**MARTINIQUE**

yellow

Sale & Pepe

mint

building

black

black

black

diffuser / diffusor

transparent glass  
 vetro trasparente

**CABLE / CAVO**  
 2000mm [79.7"] standard

black colour fabric  
 tessuto color nero

# calypso

IP20



**FLOOR / TERRA**



**ANTIGUA**

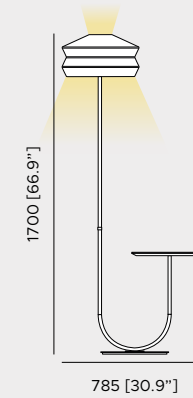

**GUADALOUPE**

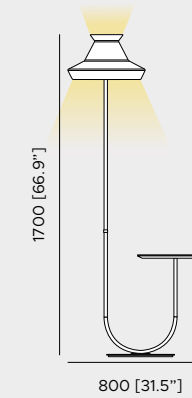

**MARTINIQUE**

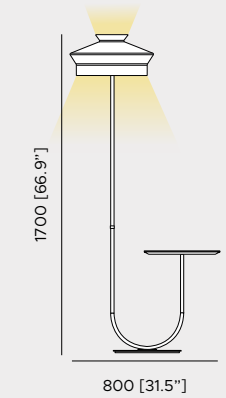

**LIGHT SOURCE / FONTE LUMINOSA**

**220-240V**  
**FLOOR / TERRA**  
 1x14 W E27  
 dimmable LED light bulb /  
 Lampadina LED dimmerabile

**110V**  
**FLOOR / TERRA**  
 1x14 W E26  
 dimmable LED light bulb /  
 Lampadina LED dimmerabile





**DIMMING / DIMMERAZIONE**

dimmable / dimmerabile

**SWITCH / INTERRUTTORE**

dimmable foot control switch / interruttore dimmerabile a piede

**FINISHES / FINITURE**  
 frame / struttura

-  matt black silk lacquered  
laccato nero seta opaco
-  green leather  
pelle verde
-  satin brass detail  
dettato ottone satinato
-  tavolino marmo verde Guatemala  
green Guatemala marble table

shade / paralume

**ANTIGUA**



**GUADALOUPE**



**MARTINIQUE**

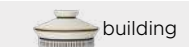

**CABLE / CAVO**  
 300mm [11.8"] +  
 2000mm [78.7"] standard

-  black colour fabric  
tessuto color nero



# — circus

DESIGN CONTARDI STUDIO

Circus represents Contardi's philosophy of the versatile "White Shirt" suitable for any context: a well-made garment that one cannot do without. This lamp integrates innovative technologies such as the wire-mounted diffuser disc, which fits perfectly to eliminate unwanted shadows on the illuminated surface. Inside, 3 or 4 bulbs close to the lampshade ensure optimal lighting performance, enhanced in the version with custom-made LED boards for greater power and energy efficiency.

Circus rappresenta la filosofia di Contardi della "Camicia bianca" versatile e adatta ad ogni contesto: un indumento ben fatto di cui non si può fare a meno. Questa lampada integra tecnologie innovative come il disco diffusore montato su filo che si incastra perfettamente per eliminare ombre indesiderate sulla superficie illuminata. Al suo interno, 3 o 4 lampadine vicino al paralume assicurano una performance luminosa ottimale, esaltata nella versione con piastre a LED realizzate ad hoc, per una maggiore potenza ed efficienza energetica.

— —

Circus suspension 900 mm [35.4"] diameter.  
Sospensione Circus diametro 900 mm [35.4"].



Circus LED suspension lamps with black trimmings, 1200 mm [47.2"] diameter.  
Sospensioni Circus LED con passamanerie nere, diametro 1200 mm [47.2"].



Circus ceiling lamp, 1500 mm [59"] diameter.  
Lampada a plafone Circus, diametro 1500 mm [59"].

# circus

IP20



**SUSPENSION / SOSPENSIONE**

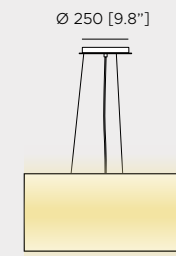

**CEILING / PLAFONE**



**SIZE AVAILABLE SHADES / DIMENSIONE PARALUMI DISPONIBILI**

**SUSPENSION - CEILING / SOSPENSIONE - PLAFONE**

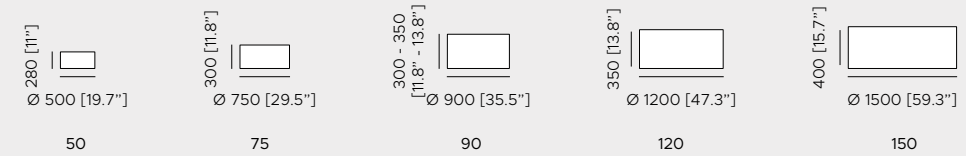

**LIGHT SOURCE / FONTE LUMINOSA**

**220-240V**  
**SUSPENSION - CEILING 50 - 75 /**  
**SOSPENSIONE - PLAFONE 50 - 75**  
 3 x 14W E27  
 LED light bulbs / lampadine LED

**110V**  
**SUSPENSION - CEILING 50 - 75 /**  
**SOSPENSIONE - PLAFONE 50 - 75**  
 3 x 14W E26  
 LED light bulbs / lampadine LED

**SUSPENSION - CEILING 90 - 120 - 150 /**  
**SOSPENSIONE - PLAFONE 90 - 120 - 150**  
 4 x 14W E27  
 LED light bulbs / lampadine LED

**SUSPENSION - CEILING 90 - 120 - 150 /**  
**SOSPENSIONE - PLAFONE 90 - 120 - 150**  
 4 x 14W E26  
 LED light bulbs / lampadine LED

**DIMMING / DIMMERAZIONE**

compatible with remote control systems when dimmable LED bulbs are used /  
 compatibile con sistemi di controllo remoto in caso di utilizzo di lampadine LED dimmerabili

**FINISHES / FINITURE**

canopy / rosone

white lacquered  
 laccato bianco

shade / paralume

white cotton  
 cotone bianco

white linen  
 lino bianco

other fabrics available on demand / altri tessuti disponibili su richiesta

trims / passamanerie

mustard  
 senape

red  
 rosso

light blue  
 azzurro

dark blue  
 blu scuro

grey  
 grigio

black  
 nero

**CABLE / CAVO**

2000mm [79.7"] standard

**SUSPENSION / SOSPENSIONE**

transparent steel  
 acciaio trasparente

steel cables for the balance  
 cavi di bilanciamento in acciaio

extra cable / cavo extra

up to 5000 mm [196.8"] on demand / fino a 5000 mm [196.8"] su richiesta  
 up to 10000 mm [393.7"] on demand / fino a 10000 mm [393.7"] su richiesta



# circus led

IP20



## SUSPENSION / SOSPENSIONE



### LED SUSPENSION

Ø 250 [9.8"]

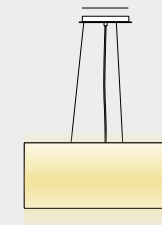

## CEILING / PLAFONE



### LED CEILING

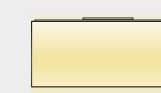

The compact LED board in Circus LED reduces the height of the lampshade compared to the traditional version, while maintaining excellent light performance.

La piastra LED compatta di Circus LED permette di ridurre l'altezza del paralume rispetto alla versione tradizionale, garantendo al contempo un'eccellente performance luminosa.

## SIZE AVAILABLE SHADES / DIMENSIONE PARALUMI DISPONIBILI

### LED SUSPENSION - LED CEILING / SOSPENSIONE LED - PLAFONE LED

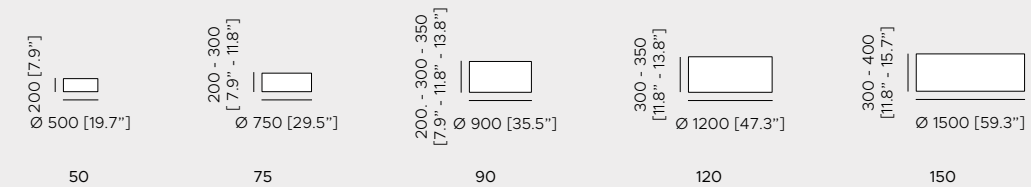

## LIGHT SOURCE / FONTE LUMINOSA

**LED SUSPENSION - LED CEILING 50 - 75 / SOSPENSIONE LED - PLAFONE LED 50 - 75**  
1 x 53W Custom LED board · 7300 Lm  
3000 K · CRI >90

**LED SUSPENSION - LED CEILING 90 - 120 - 150 / SOSPENSIONE LED - PLAFONE LED 90 - 120 - 150**  
1 x 70W Custom LED board · 10000 Lm  
3000 K · CRI >90

## DIMMING / DIMMERAZIONE

phase cut (Triac) / taglio di fase (Triac)  
1-10V · DALI on demand / 1-10V · DALI su richiesta

## FINISHES / FINITURE

canopy / rosone

white lacquered  
laccato bianco

shade / paralume

white cotton  
cotone bianco

white linen  
lino bianco

other fabrics available on demand / altri tessuti disponibili su richiesta

trims / passamanerie

mustard  
senape

red  
rosso

light blue  
azzurro

dark blue  
blu scuro

grey  
grigio

black  
nero

## CABLE / CAVO

2000mm [79.7"] standard

## SUSPENSION / SOSPENSIONE

black colour fabric  
tessuto color nero

steel cables for the balance  
cavi di bilanciamento in acciaio

extra cable / cavo extra

up to 5000 mm [196.8"] on demand / fino a 5000 mm [196.8"] su richiesta  
up to 10000 mm [393.7"] on demand / fino a 10000 mm [393.7"] su richiesta



# — claretta

DESIGN CHIARA CABERLON

Claretta is the table lamp designed by Chiara Caberlon. Inspired by the portability of the Clara collection, it is perfectly suited for both residential and hospitality projects. With its refined, wireless design, Claretta effortlessly adapts to a variety of settings: whether placed on small tables to create intimate atmospheres or arranged in series on long dining tables, it provides harmonious lighting for social gatherings. Available in four elegant finishes, Claretta beautifully balances form and function, creating warm and inviting environments.

Claretta è la lampada da tavolo firmata Chiara Caberlon. Ispirata alla trasportabilità della collezione Clara, è perfetta per inserirsi con eleganza in progetti residenziali e hospitality. Grazie al suo design raffinato e senza fili, Claretta si adatta a vari contesti: come lampada da tavolo su piccoli tavolini, ideale per creare atmosfere intime, o utilizzata in serie su ampie tavolate, per illuminare con armonia momenti di convivialità. Disponibile in quattro raffinate finiture, Claretta unisce funzione e bellezza, creando atmosfere suggestive e accoglienti.



Claretta, battery operated table lamp,  
lacquered bronze frame and transparent ribbed plexiglass diffuser.  
Claretta, lampada a batteria ricaricabile, finitura  
laccato bronzo e diffusore in plexiglass rigato trasparente.



Radial lighting effect from the light source.  
Effetto luminoso a raggiera della fonte luminosa.

Claretta, battery operated table lamp,  
golden nickel finish and transparent ribbed plexiglass diffuser.  
Claretta, lampada a batteria ricaricabile,  
finitura nickel dorato e diffusore in plexiglass rigato trasparente.





Claretta in hospitality environment,  
dark red frame and transparent ribbed plexiglass diffuser.  
Claretta in ambiente hospitality,  
struttura rosso scuro e diffusore plexiglass rigato trasparente.

# claretta

IP65

**TABLE / TAVOLO**

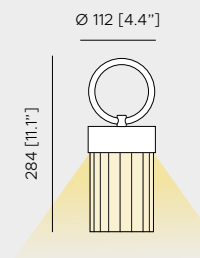

**BATTERY**

Autonomy: 6/8 hours  
 Life cycles: 600  
 Charging time: 4 hours  
 USB cable type C supplied,  
 power supply not supplied

**BATTERIA**

Autonomia: 6/8 ore  
 Cicli di vita: 600  
 Tempo di ricarica: 4 ore  
 Cavo USB tipo C fornito,  
 alimentatore non fornito

**ON / OFF SWITCHING / ACCENSIONE / SPEGNIMENTO**

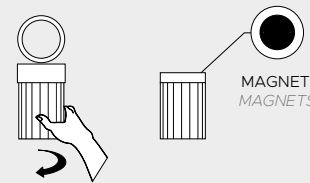





USB Type-C port for  
 charging the battery  
 of the Claretta  
 product.

Ingresso USB  
 tipo-C per caricare  
 la batteria del  
 prodotto Claretta.

**LIGHT SOURCE / FONTE LUMINOSA**

**220-240V · 110V**  
 1x3 W LED module · 400 Lm  
 3000 K · CRI >90  
 IP65

**FINISHES / FINITURE**  
 frame / struttura

-  matt white lacquered  
laccato bianco opaco
-  bronze lacquered  
laccato bronzo
-  golden nickel  
nickel dorato
-  dark red  
rosso scuro

diffuser / diffusore

 transparent ribbed plexiglass  
plexiglass rigato trasparente





# — COCO

DESIGN TRISTAN AUER & FRÉDÉRIC SICARD

Coco embodies the simple and sophisticated elegance that its name evokes. With a shiny nickel and beveled mirror structure, its design offers a refined silhouette, while Coconette stands out with a brushed light bronze matt finish. The Mini IP44 version is ideal for bathrooms, with a waterproof fabric lampshade and protected light source. The Deluxe version, enriched with some details, offers a warm and enveloping light.

Coco incarna l'eleganza semplice e sofisticata che il suo nome evoca. Con una struttura in nickel lucido e specchio smussato, il suo design offre una silhouette raffinata mentre Coconette si distingue per la finitura bronzo spazzolato chiaro opaco. La versione Mini IP44 è ideale per bagni, con paralume in tessuto impermeabile e sorgente luminosa protetta. La versione Deluxe arricchita in alcuni dettagli, offre una luce calda e avvolgente.

Coconette wall light, matt light satin bronze frame and white cotton shade.  
Lampada da parete Coconette, struttura bronzo spazzolato chiaro opaco, paralume in cotone bianco.

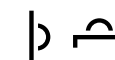



Coco wall light, polished nickel with bevelled mirror structure and white cotton shade.  
Lampada da parete Coco, finitura nickel lucido con specchio molato, paralume in cotone bianco.



Detail of the light source protection of the Coco Mini IP44 wall lamp.  
Dettaglio protezione fonte luminosa della lampada da parete  
Coco mini IP44.



Coco mini IP44 wall light.  
Lampada da parete Coco mini IP44.





Deluxe version of the Coco collection.  
Versione Deluxe della collezione Coco.

Coco Deluxe table version.  
Lampada da tavolo Coco Deluxe.



# COCO

IP20 · IP44



**WALL / PARETE**



**COCO**

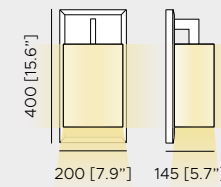

**COCONETTE**

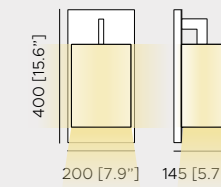

**COCO MINI IP44**

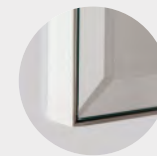
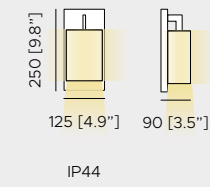

Detail of bevelled mirror.  
 Dettaglio specchio molato.

**LIGHT SOURCE / FONTE LUMINOSA**

**220-240V**  
**COCO - COCONETTE**  
 1 x 10W E27  
 LED light bulb / lampadina LED

**110V**  
**COCO - COCONETTE**  
 1 x 10W E26  
 LED light bulb / lampadina LED

**COCO MINI IP44**  
 1 x 9W G9  
 LED light bulb / lampadina LED  
 IP44

**DIMMING / DIMMERAZIONE**

compatible with remote control systems when dimmable LED bulbs are used /  
 compatibile con sistemi di controllo remoto in caso di utilizzo di lampadine LED dimmerabili

**FINISHES / FINITURE**

frame / struttura  
**COCO**

**COCO MINI IP44**

**COCONETTE**

diffuser / diffusore  
**COCO - COCONETTE**

**COCO MINI IP44**

polished nickel with bevelled mirror  
 nickel lucido con specchio molato

polished nickel  
 nickel lucido

matt light satin bronze  
 bronzo spazzolato chiaro opaco

white cotton  
 cotone bianco

waterproof white fabric  
 tessuto impermeabile bianco

# COCO

IP20



**WALL / PARETE**



**DELUXE**

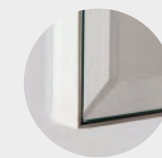
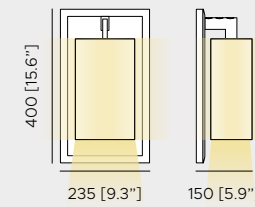

Detail of bevelled mirror.  
Dettaglio specchio molato.

**TABLE / TAVOLO**



**DELUXE**

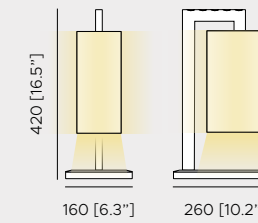

Shaped arm detail.  
Dettaglio braccetto sagomato

**LIGHT SOURCE / FONTE LUMINOSA**

**220-240V**  
**WALL - TABLE / PARETE - TAVOLO**  
1 x 10W E27  
LED light bulb / lampadina LED

**110V**  
**WALL - TABLE / PARETE - TAVOLO**  
1 x 10W E26  
LED light bulb / lampadina LED

**DIMMING / DIMMERAZIONE**

**TABLE / TAVOLO**  
dimmer switch on the cable available on demand, compatible with dimmable LED light bulbs only / disponibile su richiesta versione con dimmer su cavo, compatibile solo con lampadine LED dimmerabili

**SWITCH / INTERRUTTORE**

ON-OFF switch on cable / interruttore ON-OFF su cavo

**FINISHES / FINITURE**  
frame / struttura

polished nickel with bevelled mirror  
nickel lucido con specchio molato

diffuser / diffusore

white cotton  
cotone bianco

**CABLE / CAVO**  
2000mm [79.7"] standard

**TABLE / TAVOLO**  
black colour fabric  
tessuto color nero



# — cube

DESIGN MASSIMILIANO RAGGI

Cube is an elegant and innovative lantern. Its outer structure in composite material features a brushed bronze effect finish. The gold lacquered metal interior creates a sophisticated contrast, while the grooved diffuser emits a refined light. Cube is perfect for adding warmth and distinctive style to any environment.

Cube è una lanterna da appoggio elegante e innovativa. La sua struttura esterna in materiale composito è caratterizzata da una finitura bronzo spazzolato. L'interno in metallo laccato oro crea un contrasto sofisticato, mentre il diffusore rigato emana una luce raffinata. Cube è perfetta per aggiungere calore e stile distintivo a qualsiasi ambiente.



Cube floor lamps.  
Lampade da terra Cube.



Detail of the hexagonal top of Cube and the handle.  
Dettaglio parte superiore esagonale di Cube e maniglia.



Floor lamps: small and large versions.  
Lampade da terra versioni small e large.

# cube

IP20



FLOOR / TERRA



SMALL

LARGE

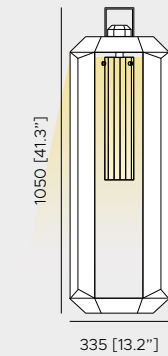
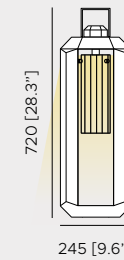

LIGHT SOURCE / FONTE LUMINOSA

**220-240V**  
1 x 14W E27  
dimnable LED light bulb /  
lampadina LED dimmerabile

**110V**  
1 x 14W E26  
dimnable LED light bulb /  
lampadina LED dimmerabile

DIMMING / DIMMERAZIONE

dimnable / dimmerabile

SWITCH / INTERRUTTORE

dimnable foot control switch / interruttore dimmerabile a piede

FINISHES / FINITURE

frame / struttura

● outside: satin bronze  
bronzo spazzolato

● inside: gold lacquered  
interno: laccato oro

diffuser / diffusore

▨ transparent ribbed plexiglass  
plexiglass rigato trasparente

CABLE / CAVO

2000mm [79.7\"/>

● black colour fabric  
tessuto color nero



# — discus

DESIGN MKV DESIGN

Discus offers pendant, wall, and ceiling lamps with a compact and modern design, ideal for hospitality, commercial, and residential spaces. MKV Design studio recently introduced significant improvements: expanding the central ring's finish options, providing more space for the satin opal diffuser for an even softer and more welcoming light. Discus represents a true lighting solution for various environments and elegantly adapts to any decor while maintaining timeless appeal.

Discus offre lampade a sospensione, a parete e a plafone dal design compatto e moderno, ideali per ambienti hospitality, commerciali e residenziali. Lo studio MKV Design ha recentemente introdotto miglioramenti significativi: aumentano le opzioni di finitura dell'anello centrale che lascia ulteriore spazio al diffusore in opale satinato per una luce ancora più diffusa e accogliente.

Discus rappresenta una vera e propria soluzione illuminotecnica per diversi ambienti e si adatta con eleganza a ogni arredamento, mantenendo un fascino senza tempo.

— — |

Discus wall light, large version, matt black silk lacquered structure and satin brass ring.

Lampada a parete Discus, versione large, struttura laccato nero seta opaco e anello ottone satinato.



Discus large suspension, white lacquered structure and polished nickel ring.  
Discus sospensione large, struttura laccata bianco opaco, anello nickel lucido.





Discus wall light small version, matt black silk lacquered structure and satin brass ring.  
Lampada a parete, versione small, struttura laccato nero seta opaco e anello ottone satinato.



Discus offers multiple finish options for the central ring, which, thanks to the new product engineering, provides additional space for the satin opal diffuser, allowing for a softer and more diffused light.

Discus presenta molteplici opzioni di finitura dell'anello centrale che, grazie alla nuova ingegnerizzazione del prodotto, lascia ulteriore spazio al diffusore opale satinato per una luce più diffusa e morbida.

Ceiling lamp, large version,  
matt black silk lacquered structure, brushed bronze-nickel ring.  
Lampada a plafone, versione large, struttura laccato nero seta opaco,  
anello finitura bronzo-nickel spazzolato.



# discus

IP20



## SUSPENSION / SOSPENSIONE



### SMALL

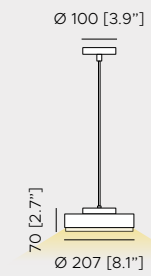

### LARGE

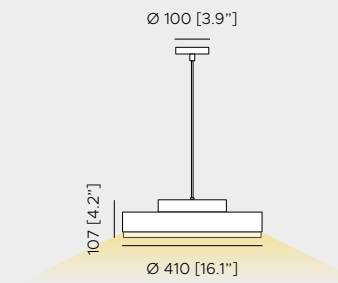

## CEILING / PLAFONE



### SMALL

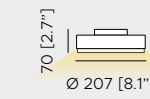

### LARGE

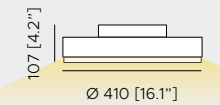

## LIGHT SOURCE / FONTE LUMINOSA

**220-240V · 110V**

**SMALL**  
1x14.3 W LED module · 2450 Lm  
2700 K · CRI >90

**LARGE**  
1x32.4 W LED module · 5688 Lm  
2700 K · CRI >90

## DIMMING / DIMMERAZIONE

phase cut (Triac) / taglio di fase (Triac)  
1-10V · DALI on demand / 1-10V · DALI su richiesta

## FINISHES / FINITURE

frame / struttura

● matt black silk lacquered  
laccato nero seta opaco

● matt white lacquered  
laccato bianco opaco

central band / banda centrale

● brushed bronze-nickel  
bronzo-nickel spazzolato

● satin brass  
ottone satinato

● polished nickel  
nickel lucido

diffuser / diffusore

● opal white plexiglass  
plexiglass bianco opaco

## CABLE / CAVO

2000mm [79.7"] standard

● black colour fabric  
tessuto color nero

extra cable / cavo extra

up to 5000 mm [196.8"] on demand / fino a 5000 mm [196.8"] su richiesta  
up to 10000 mm [393.7"] on demand / fino a 10000 mm [393.7"] su richiesta

# discus

IP20



**WALL / PARETE**



**SMALL**

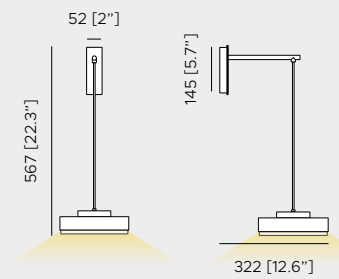

**LARGE**

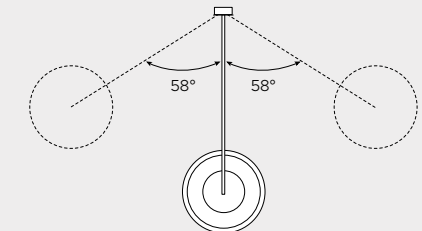
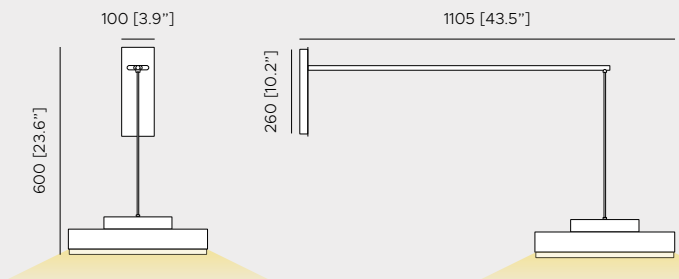

ARM ROTATION /  
ROTAZIONE DEL BRACCIO

**LIGHT SOURCE / FONTE LUMINOSA**

**220-240V · 110V**

**SMALL**  
1x14.3 W LED module · 2450 Lm  
2700 K · CRI >90

**LARGE**  
1x32.4 W LED module · 5688 Lm  
2700 K · CRI >90

**DIMMING / DIMMERAZIONE**

phase cut (Triac) / taglio di fase (Triac)  
1-10V · DALI on demand / 1-10V · DALI su richiesta

**FINISHES / FINITURE**

frame / struttura

● matt black silk lacquered  
laccato nero seta opaco

● matt white lacquered  
laccato bianco opaco

central band / banda centrale

● brushed bronze-nickel  
bronzonickel spazzolato

● satin brass  
ottone satinato

● polished nickel  
nickel lucido

diffuser / diffusore

● opal white plexiglass  
plexiglass bianco opaco

**CABLE / CAVO**

2000mm [79.7"] standard

● black colour fabric  
tessuto color nero

extra cable / cavo extra

up to 5000 mm [196.8"] on demand / fino a 5000 mm [196.8"] su richiesta  
up to 10000 mm [393.7"] on demand / fino a 10000 mm [393.7"] su richiesta

# modified stock

## CHANGE RING COLOURS / CAMBIO COLORE ANELLO



Possibility, for minimum quantities, to choose the finish of the ring. Contardi, thanks to its tailoring skills is able to characterise the band with trimmings, leather or other materials, thus personalising the product.

Possibilità, per quantitativi minimi, di scegliere la finitura dell'anello. Contardi, grazie alle sue abilità sartoriali è in grado di caratterizzare la fascia con passamanerie, pelli o altri materiali, personalizzando così il prodotto.

-  oro lucido  
polished gold
-  satin golden nickel  
nickel dorato satinato
-  Customised finishing  
or RAL colour chosen by the customer  
finitura personalizzata con passamaneria  
o RAL scelto dal cliente

## CHANGE FRAME COLOURS / CAMBIO COLORE STRUTTRA



Possibility, for minimum quantities, to change the finish of the structure of the Discus collection.

Possibilità, per quantitativi minimi, di cambiare la finitura della struttura del prodotto Discus.

-  Customised finishing or  
RAL colour chosen by the customer  
finitura personalizzata con finitura  
o RAL scelto dal cliente

## DIMMING SYSTEMS / SISTEMI DI DIMMERAZIONE

The dimmer is a light regulator that, thanks to an electronic circuit, adjusts the power supply voltage of the lighting device and, consequently, controls the brightness of the lamp. Dimming systems available for Discus, upon request with minimum order quantities:

- 0-10V
- DALI
- Casambi

Il dimmer è un regolatore di luce che grazie ad un circuito elettronico varia la tensione di alimentazione dell'apparecchio adibito all'illuminazione e, di conseguenza, regola la luminosità stessa della lampada.

Sistemi di dimmerazione possibili per Discus, su richiesta con quantitativi minimi:

- 0-10V
- DALI
- Casambi

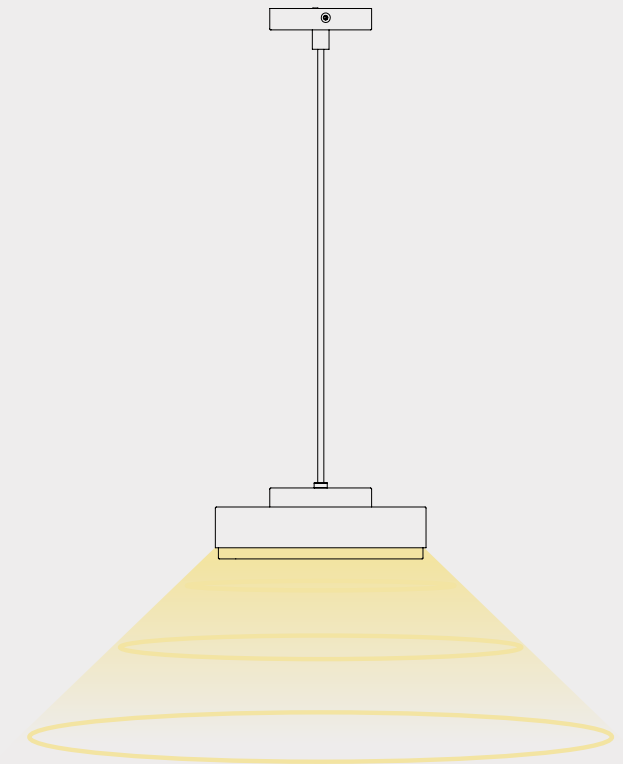

## TUNABLE WHITE AND KELVIN / BIANCO DINAMICO E KELVIN



Tunable white is a versatile and innovative solution that offers greater light quality and finer control over the illuminated environment. The tunable white system uses LEDs with different colour temperatures.

This adjustment allows the lighting to be adapted to the specific needs of a room or time of day, enhancing comfort and functionality.

Available on request for minimum quantities.

Il bianco dinamico è una soluzione versatile e innovativa che offre una maggiore qualità della luce e un controllo più fine sull'ambiente illuminato. Il sistema di bianco dinamico utilizza LED a diverse temperature di colore. Questa regolazione permette di adattare l'illuminazione alle esigenze specifiche di un ambiente o di un momento della giornata, migliorando comfort e funzionalità.

Disponibile su richiesta per quantitativi minimi.



# — eclisse e vegas

DESIGN MASSIMILIANO RAGGI

Eclisse and Vegas are pendant lamps inspired by a solar eclipse and one of the brightest stars in the celestial vault, respectively. The wooden rings are coated with metallic powder in light and dark bronze finishes. In Eclisse, the light diffuses through the two outer rings, while in Vegas, the main lighting is in the spotlights inside the rosette, and secondary lighting in the smaller rings with LED Panels.

Eclisse e Vegas, lampade sospese ispirate rispettivamente all'eclisse solare e a uno degli astri più luminosi della volta celeste. Gli anelli in legno sono verniciati con polveri metalliche in finitura bronzo chiaro e scuro. La luce in Eclisse si diffonde attraverso i due anelli esterni, mentre in Vegas l'illuminazione principale è nei faretti posti all'interno del rosone, quella secondaria negli anelli più piccoli con dei Panel LED.

h

Eclisse suspension lamp.  
Lampada a sospensione Eclisse.



Eclisse suspension lamp.  
Lampada a sospensione Eclisse



The wooden rings are coated with a liquid metal powder finish, giving them a sophisticated brushed bronze effect.  
Gli anelli in legno sono realizzati grazie alla verniciatura a liquido con polveri di metallo per conferire un elegante effetto bronzo spazzolato sulla superficie.



Vegas suspension lamp.  
Lampada a sospensione Vegas.



# eclisse e vegas

IP20



**SUSPENSION / SOSPENSIONE**



**ECLISSE**

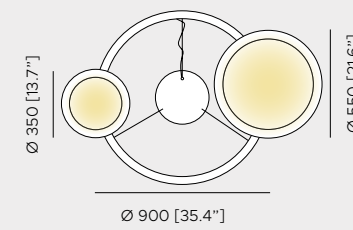
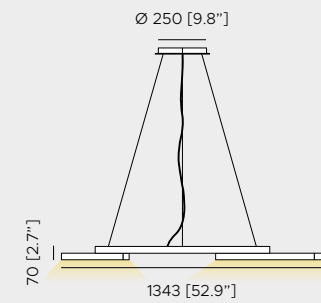

**VEGAS**

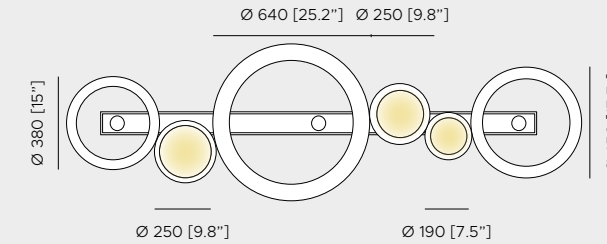
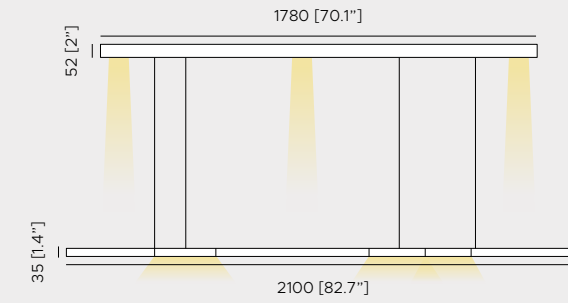

**LIGHT SOURCE / FONTE LUMINOSA**

**220-240V · 110V**

**ECLISSE**  
1x17 W Panel LED · 1430 Lm + 1x28 W Panel LED · 2270 Lm  
2700 K · CRI >90

**VEGAS**  
canopy / rosone 3x12 W COB LED · 5400 Lm  
rings / anelli 1x8 W Panel LED · 650 Lm + 2x10 W Panel LED · 2100 Lm  
2700 K · CRI >90

**DIMMING / DIMMERAZIONE**

phase cut (Triac) / taglio di fase (Triac)  
1-10V · DALI on demand / 1-10V · DALI su richiesta

**FINISHES / FINITURE**  
frame / struttura

**LARGE RINGS AND CANOPY / ANELLI GRANDI E ROSONE**

● satin bronze  
bronzo spazzolato

**SMALL RINGS / ANELLI PICCOLI**

● matt light satin bronze  
bronzo spazzolato chiaro opaco

diffuser / diffusore

● alabaster effect alycrite  
alycrite effetto alabastro

**CABLE / CAVO**  
2000mm [79.7"] standard

● transparent steel / acciaio trasparente ● steel cables for the balance / cavi di bilanciamento in acciaio

extra cable / cavo extra

up to 5000 mm [196.8"] on demand / fino a 5000 mm [196.8"] su richiesta



# — emma

DESIGN CONTARDI STUDIO

Emma arises from two geometric elements meeting in an elegant sculptural form. With a base made of green Guatemala marble or white Calacatta marble, this collection explores sinuous shapes with opal white spherical diffusers that distribute light evenly. Suitable for any environment, from homes to luxury boutiques, Emma is available in table, ceiling, and wall versions.

Emma nasce da due elementi geometrici che si incontrano in una elegante forma scultorea. Con base realizzata in marmo verde Guatemala o bianco Calacatta, questa collezione esplora le forme sinuose con diffusori sferici opalini bianchi che distribuiscono la luce in modo uniforme. Adatta a ogni ambiente, dalle case alle boutique di lusso, Emma è disponibile nelle varianti da tavolo, soffitto e parete.

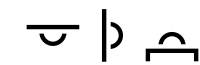

Emma table lamp, white Calacatta marble base, white opal diffuser.

Lampada da tavolo Emma, base in marmo bianco Calacatta, diffusore bianco opale.



Emma wall lamp, green Guatemala marble frame with opal diffuser.  
Lampada da parete Emma, finitura marmo verde Guatemala con sfera opale.



Emma ceiling lamps, green Guatemala marble frame with opal diffuser.  
Lampade a plafone Emma, finitura marmo verde Guatemala con sfera opale.

# emma

IP20

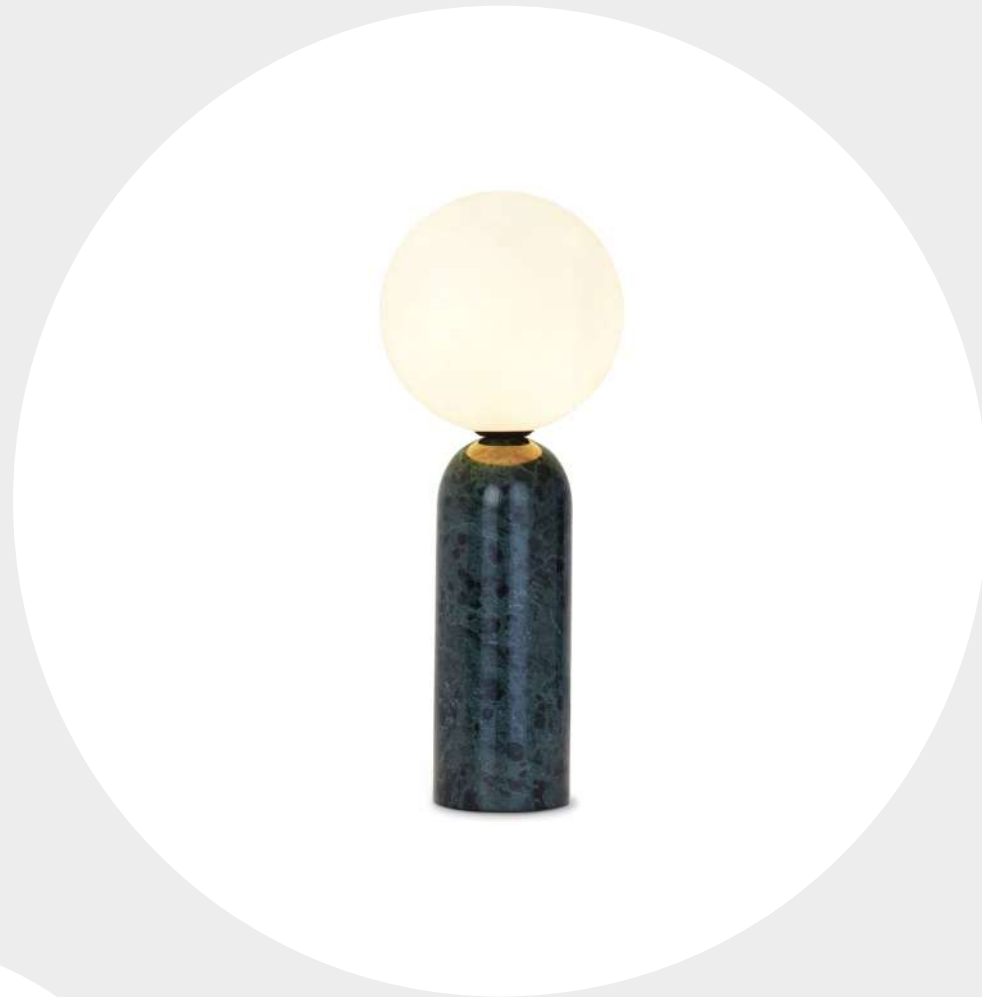

**WALL / PARETE**

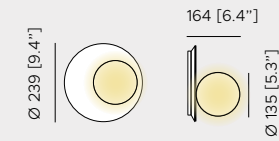

**CEILING / PLAFONE**

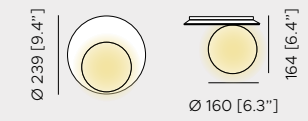

**TAVOLO / TABLE**

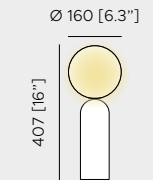

**LIGHT SOURCE / FONTE LUMINOSA**

**220-240V · 110V**  
1x7 W G9  
dimnable LED bulb / lampadina LED dimmerabile

**DIMMING / DIMMERAZIONE**

**WALL - CEILING / PARETE - PLAFONE**  
compatible with remote control systems when dimmable LED bulbs are used /  
compatibile con sistemi di controllo remoto in caso di utilizzo di lampadine LED dimmerabili

**TABLE / TAVOLO**  
dimmable / dimmerabile

**SWITCH / INTERRUTTORE**

**TABLE / TAVOLO**  
switch on cable / interruttore su cavo

**FINISHES / FINITURE**  
frame / struttura

 green Guatemala marble / marmo verde Guatemala  white Calacatta marble / marmo bianco Calacatta

diffuser / diffusore

 opal white glass / sfera bianca opale

**CABLE / CAVO**  
2000mm [79.7\"/>

**TABLE / TAVOLO**  
 black colour fabric / tessuto color nero



# — flexiled

DESIGN KING & ROSELLI

Flexiled, a historic and iconic product of the Contardi collection, is available in two variants, with a flexible arm covered in double-stitched leather or steel mesh, offering customization options in colours and sizes. The brass arm ensures solidity and silent movements. Perfect heat dissipation guarantees a very low operating temperature even after 24 hours of continuous use.

Flexiled, prodotto storico e iconico della collezione di Contardi, disponibile in due varianti, con braccio flessibile rivestito in pelle con doppia cucitura o maglia d'acciaio, offre opzioni di personalizzazione nei colori e nelle dimensioni. Il braccio in ottone garantisce solidità e movimenti silenziosi. La perfetta dissipazione del calore garantisce una temperatura di funzionamento molto bassa anche dopo 24 ore di uso continuo.

Flexiled reading light, with a flexible arm covered in dark brown leather, and a satin nickel finish base with switch.

Lampada da lettura Flexiled, con braccio flessibile ricoperto in pelle marrone testa di moro, base nella finitura nickel satinato con interruttore.





Flexiled floor lamp and wall lights.  
Lampade da terra e a parete Flexiled.



Flexible arm made of brass 12 mm [0.4"] diameter: this prevents from any squeaking even after a prolonged use of the product. In the steel version, the steel mesh covering the tube is protected by a transparent heat-shrinkable silicone sheath.

Braccio flessibile in ottone diametro 12 mm [0.4"] che consente un uso prolungato del prodotto senza alcun cigolio. Nella versione steel, la maglia d'acciaio che ricopre il tubolare è protetta da una guaina in silicone trasparente termo restringente.

Flexiled with a flexible arm covered in ivory leather, and a base in satin nickel finish with switch.

Flexiled con braccio flessibile ricoperto in pelle avorio, base nella finitura nickel satinato con interruttore.





The leather covering of Flexiled is hand-stitched, making the stitching a valuable detail. The heat sink is designed to maintain a very low operating temperature.

Il rivestimento in pelle di Flexiled viene cucito a mano, rendendo le impunture un dettaglio prezioso. Il dissipatore di calore è in grado di tenere la temperatura di funzionamento molto bassa.



Flexiled, floor lamp, stem and arm in dark brown leather and black finish base.  
Lampada da terra Flexiled, struttura e braccio in pelle rivestita in testa di moro e base nera.



# flexiled

IP20



**WALL / PARETE**



**LEATHER**

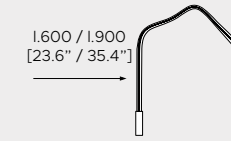

**STEEL**

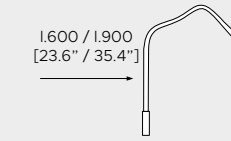

**FLOOR / TERRA**

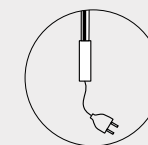
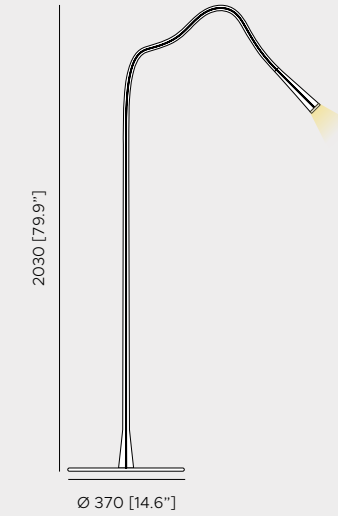

Installation with exit fabric cable from the bottom or the back of the base and plug.

Installazione con cavo in tessuto in uscita da sotto o dietro la base e spina.

**LIGHT SOURCE / FONTE LUMINOSA**

**220-240V · 110V**

**WALL / PARETE**

1x3 W LED module · 400 Lm  
2700 K · CRI >90

**FLOOR / TERRA**

1x7 W LED module · 800 Lm  
2700 K · CRI >90

**DIMMING / DIMMERAZIONE**

**FLOOR / TERRA**

dimmable / dimmerabile

**SWITCH / INTERRUTTORE**

**FLOOR / TERRA**

dimmable foot control switch / interruttore dimmerabile a piede

**FINISHES / FINITURE**

base / basetta  
**WALL / PARETE**

**FLOOR / TERRA**

frame / struttura  
**WALL / PARETE · FLOOR / TERRA**

**WALL / PARETE**

● satin bronze  
bronzo spazzolato

● satin nickel  
nickel satinato

● matt black silk lacquered  
laccato nero seta opaco

● ivory leather  
pelle avorio

● black leather  
pelle nera

● dark brown leather  
pelle marrone testa di moro

● braided steel mesh  
maglia d'acciaio intrecciata

**CABLE / CAVO**

2000mm [79.7"] +  
300mm [11.8"] standard

● black colour fabric  
tessuto color nero



# — fly

DESIGN MASSIMILIANO RAGGI

Fly is a lamp with expressive and graphic lines that transform into a sculpture, perfect for illuminating and decorating any space with style. Available in satin golden nickel, brushed bronze-nickel, and anthracite. In some versions, Fly offers an adjustable textile diffuser with the "vela" accessory. The dual light emission creates cozy and functional atmospheres.

Fly è una lampada dalle linee espressive e grafiche che si trasformano in una scultura, perfetta per illuminare e decorare con stile ogni ambiente. Disponibile in nickel dorato satinato, bronzo-nickel spazzolato e antracite. Fly, in alcune declinazioni, offre un diffusore tessile regolabile grazie all'accessorio "vela". La doppia emissione luminosa crea atmosfere accoglienti e funzionali.

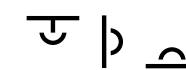

Fly Multiple, suspension lamp, brushed-bronze nickel finish.  
Lampada a sospensione Fly Multipla, finitura bronzo-nickel spazzolato.



Fly multiple, satin golden nickel finish.  
Fly multipla, finitura nickel dorato satinato.



Detail of the joints to adjust the orientation of the arms on the Fly multiple.  
 Dettaglio degli snodi per scegliere l'orientamento dei bracci su Fly multipla.

Fly multiple suspension offers versatility with numerous possible configurations.

La sospensione Fly multipla offre versatilità con numerose composizioni possibili.

Thanks to the joints, it is possible to adjust the orientation of the arms, thus determining the configuration of the lamp.

Grazie agli snodi, è possibile scegliere l'orientamento dei bracci, determinando così la configurazione della lampada.

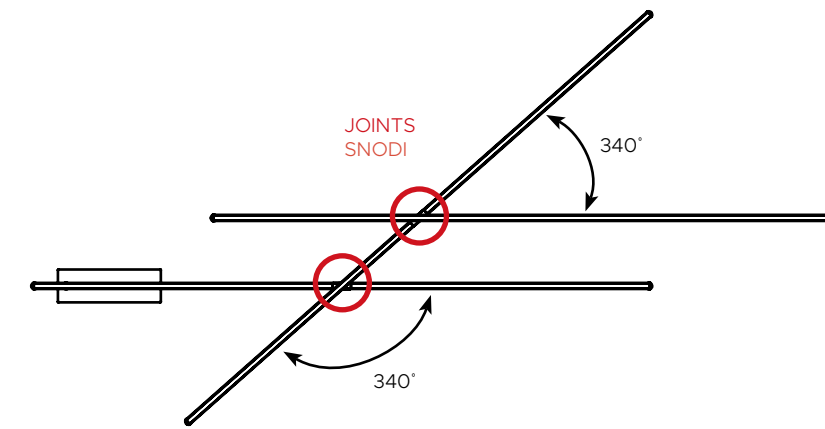

**FLY MULTIPLE COMPOSITION EXAMPLES**  
**ESEMPI COMPOSITIVI FLY MULTIPLA**

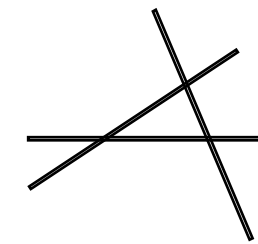

Example **A**  
 Esempio **A**

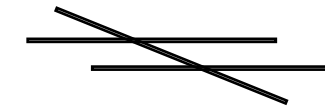

Example **B**  
 Esempio **B**

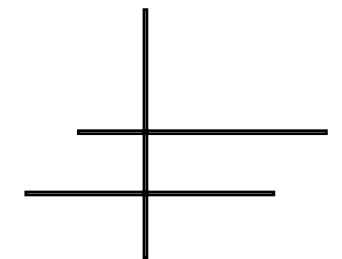

Example **C**  
 Esempio **C**



The fabric lampshade is available in two finishes:  
white cotton and white Calacatta marble printed fabric.  
Il paralume in tessuto è disponibile in due finiture:  
cotone bianco e tessuto effetto marmo bianco Calacatta.



Fly suspension lamp, length 1700 mm [66.9"].  
Lampada a sospensione Fly, lunghezza 1700 mm [66.9"].



Fly linear suspension version and Fly floor lamp, height 1900 mm [74.8"] both in brushed bronze-nickel finish.

Fly sospensione versione linear e Fly da terra, altezza 1900 mm [74.8"], entrambi nella finitura bronzo-nickel spazzolato.



With the Fly wall lights, it is possible to design compositions of up to 5 lamps using a single electrical wall outlet.

Con le lampade a parete Fly è possibile progettare composizioni, per un massimo di 5 lampade, attraverso una sola uscita elettrica a parete.

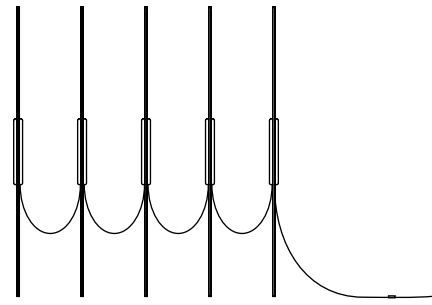

Configuration example (max. 5 lamps)  
esempio configurazione (max. 5 lampade)

Fly wall lamp, satin golden nickel finish.  
Lampada a parete Fly, finitura nickel dorato satinato.



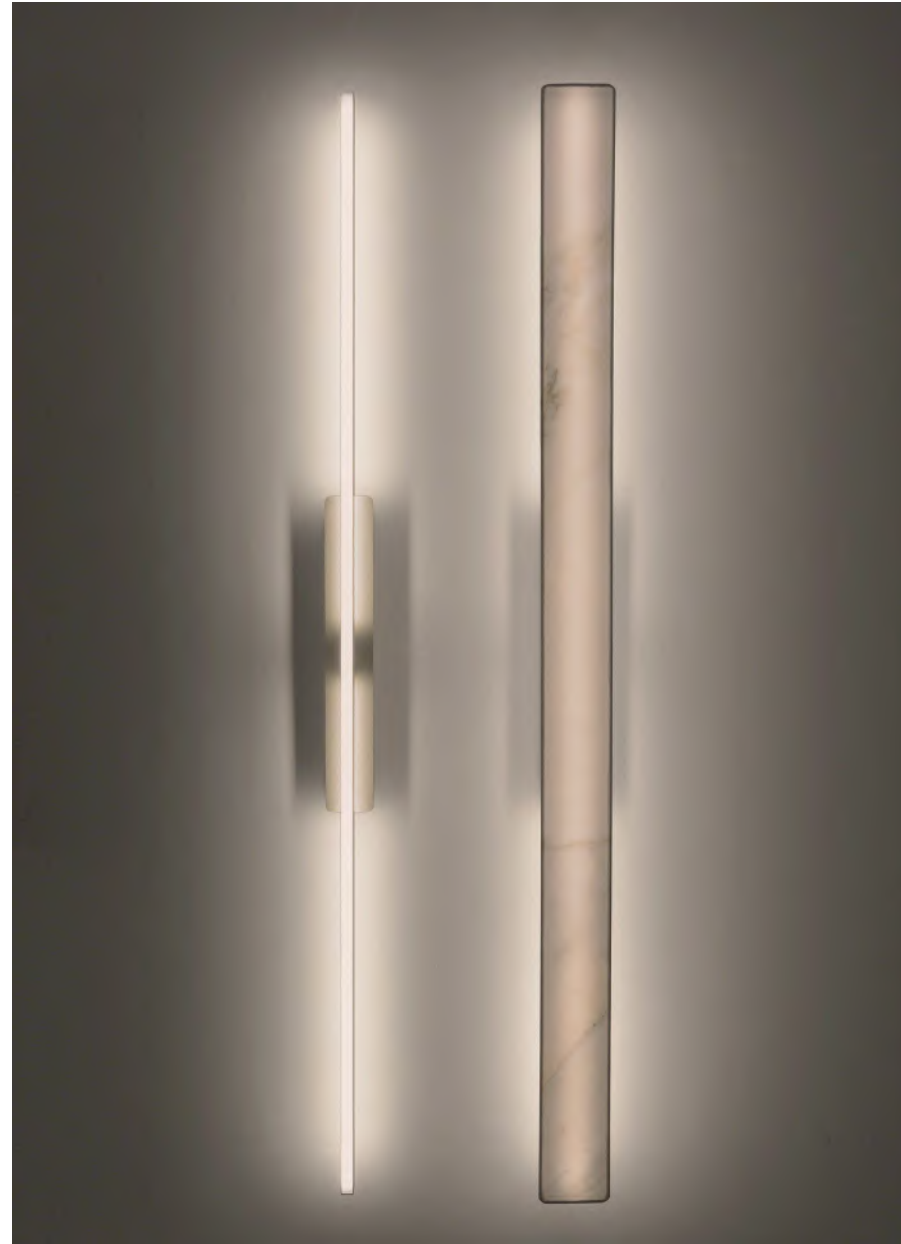

Fly available without and with the "vela" shade.  
Fly senza e con paralume "vela".

Fly wall light, remote driver version.  
Lampade a parete Fly, versione con alimentatore remoto.

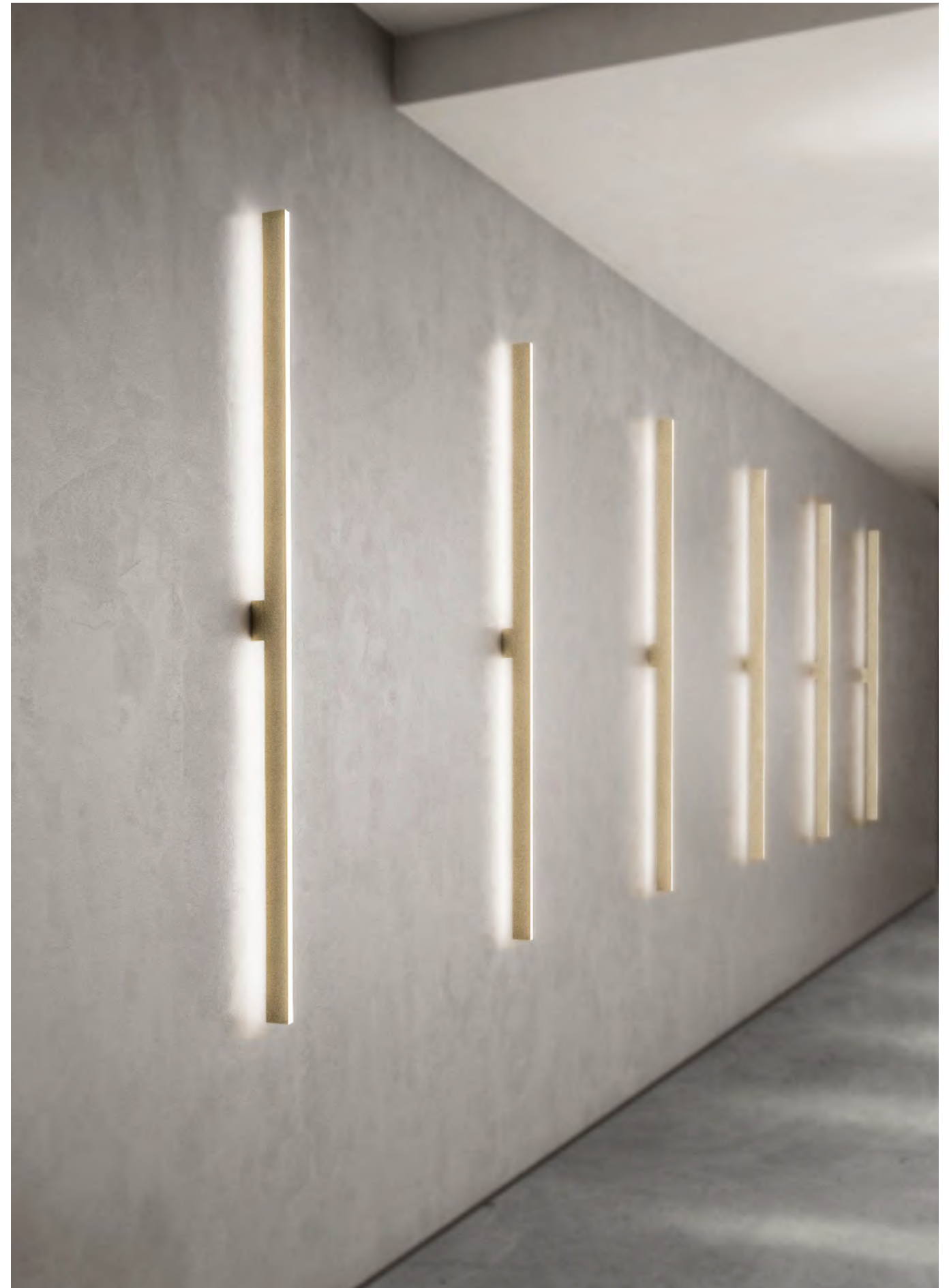





Fly Picture, in satin golden nickel finish. The Fly Picture profile is adjustable to ensure precise and uniform lighting.  
 Fly Picture, finitura nickel dorato satinato.  
 Il profilo di Fly picture è orientabile così da garantire un'illuminazione puntuale ed omogenea.



Fly Picture with IP44 protection rating, brushed bronze-nickel finish.  
 Fly Picture con grado di protezione IP44, finitura bronzo-nickel spazzolato.



The dual touch switch allows to turn on and dim the light from one or both sides of the product.

Il doppio interruttore touch permette di accendere e dimmerare la luce da uno o entrambi i lati del prodotto.

Fly Long, floor lamp, height 2500 mm [98.4"], satin golden nickel finish.  
Lampada da terra Fly Long, altezza 2500 mm [98.4"], finitura nickel dorato satinato.





Fly Torch provides indirect lighting towards the wall and upwards.  
Fly Torch con luce indiretta verso la parete e verso l'alto.

# fly

IP20



## SUSPENSION / SOSPENSIONE



### LINEAR L.1200 / 1700

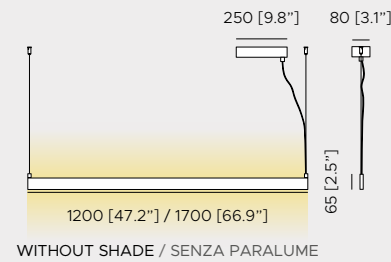

WITHOUT SHADE / SENZA PARALUME



### L.1200 / 1700

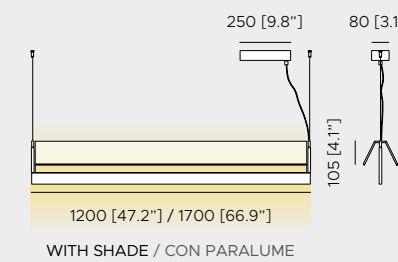

WITH SHADE / CON PARALUME



### MULTIPLE

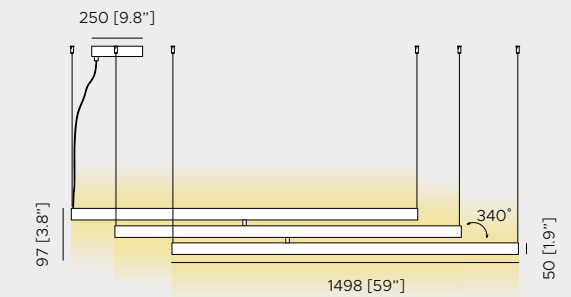

## LIGHT SOURCE / FONTE LUMINOSA

double emission / doppia emissione

### 220-240V - 110V

#### LINEAR L.1200 - L.1200

upper emission / emissione superiore 1x23 W Strip LED · 2725 Lm  
lower emission / emissione inferiore 1x17 W Strip LED · 1950 Lm  
2.700 K · CRI >90

#### LINEAR L.1700 - L.1700

upper emission / emissione superiore 1x33 W Strip LED · 3910 Lm  
lower emission / emissione inferiore 1x24 W Strip LED · 2780 Lm  
2.700 K · CRI >90

#### MULTIPLE / MULTIPLA

upper emission / emissione superiore 1x28.5 W + 2x8 W + 2x19.5W Strip LED · 10050 Lm tot.  
lower emission / emissione inferiore 1x20.3 W + 4x9.8 W Strip LED · 7055 Lm tot.  
2.700 K · CRI >90

## DIMMING / DIMMERAZIONE

phase cut · Triac / taglio di fase · Triac  
1-10V · DALI on demand / 1-10V · DALI su richiesta

## FINISHES / FINITURE

frame / struttura



anthracite  
antracite



brushed bronze-nickel  
bronzo-nickel spazzolato



satin golden nickel  
nickel dorato satinato

## CABLE / CAVO

2000mm [79.7"] standard

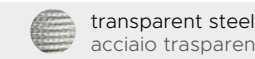

transparent steel  
acciaio trasparente



steel cables for the balance  
cavi di bilanciamento in acciaio

extra cable / cavo extra

up to 5000 mm [196.8"] on demand / fino a 5000 mm [196.8"] su richiesta  
up to 10000 mm [393.7"] on demand / fino a 10000 mm [393.7"] su richiesta

## ACCESSORIES / ACCESSORI

FLY L.1200 / 1700  
shade / paralume



white cotton  
cotone bianco



white Calacatta marble printed fabric  
tessuto stampato effetto marmo bianco Calacatta

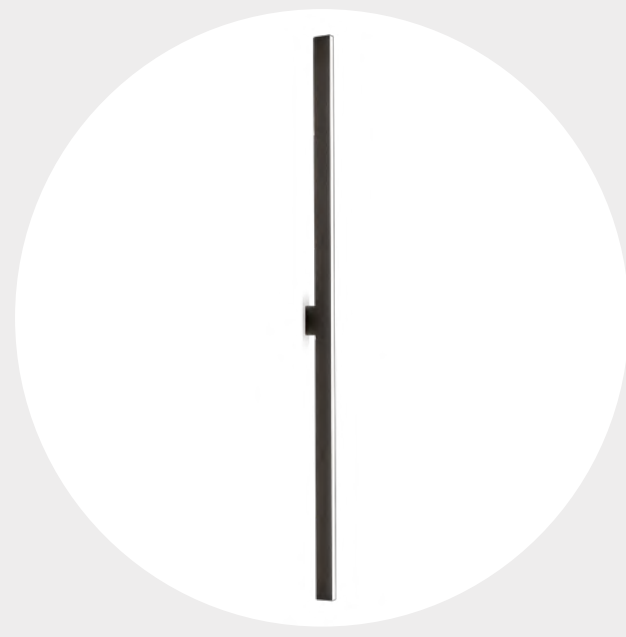

# fly

IP20 · IP44

**WALL / PARETE**



**WALL**

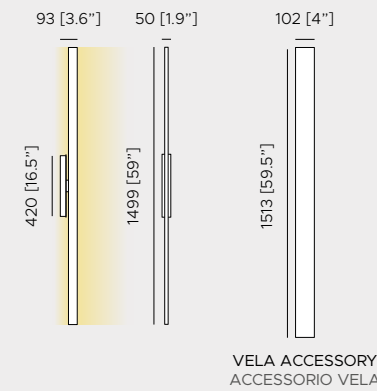

**REMOTE**

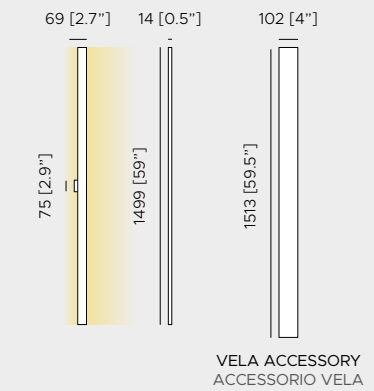

**PICTURE L.600 / 900**

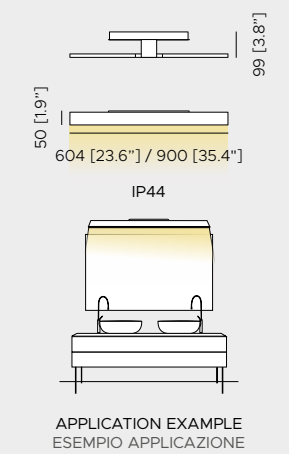

**LIGHT SOURCE / FONTE LUMINOSA**  
double emission / doppia emissione

mono-emissione / mono-emissione

**220-240V - 110V**  
**WALL - REMOTE / PARETE - REMOTE**  
upper emission / emissione superiore 1x21 W Strip LED · 2400 Lm  
back emission / emissione posteriore 2x14 W Strip LED · 3320 Lm  
2.700 K · CRI >90

**PICTURE L.600**  
1x11.5 W Strip LED · 1150 Lm  
2.700 K · CRI >90  
IP44

**PICTURE L.900**  
1x17.5 W Strip LED · 2070 Lm  
2.700 K · CRI >90  
IP44

**DIMMING / DIMMERAZIONE**

phase cut · Triac / taglio di fase · Triac  
1-10V · DALI on demand / 1-10V · DALI su richiesta

**FINISHES / FINITURE**  
frame / struttura

- anthracite  
antracite
- brushed bronze-nickel  
bronzonickel spazzolato
- satin golden nickel  
nickel dorato satinato

**ACCESSORIES / ACCESSORI**

**FLY WALL - REMOTE**  
shade / paralume

- white cotton  
cotone bianco
- white Calacatta marble printed fabric  
tessuto stampato effetto marmo bianco Calacatta

# fly

IP20

**FLOOR / TERRA**



**FLOOR**

**LONG**

**TORCH**

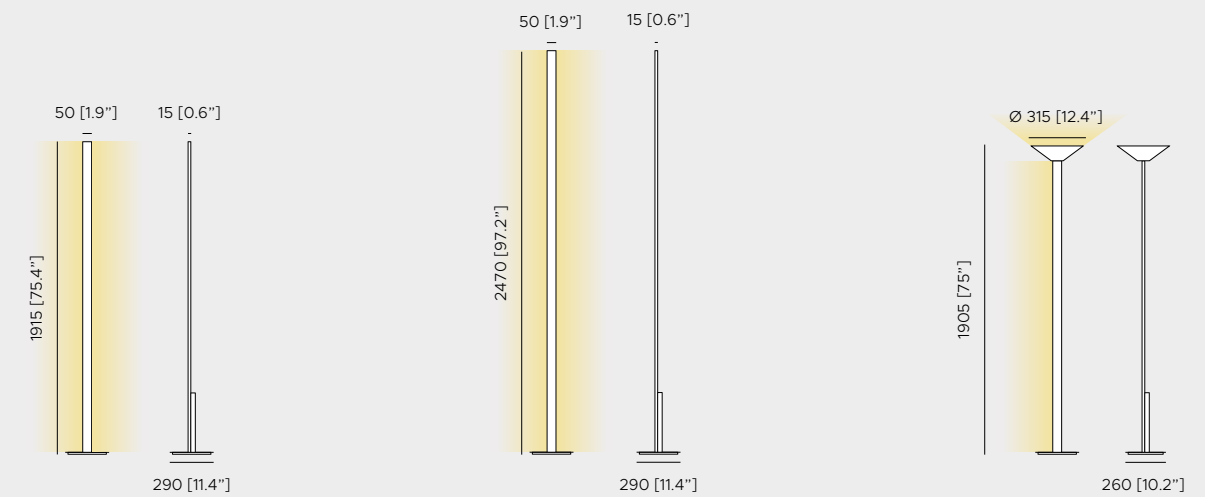

**LIGHT SOURCE / FONTE LUMINOSA**  
double emission / doppia emissione

**220-240V - 110V**

**FLOOR / TERRA**  
front emission / emissione frontale 1x26.5 W Strip LED · 3150 Lm  
back emission / emissione retro 1x38 W Strip LED · 4500 Lm  
2.700 K · CRI >90

**LONG**  
front emission / emissione frontale 1x34.5 W Strip LED · 4050 Lm  
back emission / emissione retro 1x49 W Strip LED · 5800 Lm  
2.700 K · CRI >90

**TORCH**  
upper emission / emissione superiore 1x45 W Strip LED · 5600 Lm  
back emission / emissione retro 1x25 W Strip LED · 3000 Lm  
2.700 K · CRI >90

**DIMMING / DIMMERAZIONE**

dimmable / dimmerabile

**SWITCH / INTERRUTTORE**

dimmable with double switch on board / dimmerabile con doppio interruttore a bordo

**FINISHES / FINITURE**

frame / struttura



anthracite  
antracite



brushed bronze-nickel  
bronzo-nickel spazzolato



satin golden nickel  
nickel dorato satinato

# modified stock

## CUSTOMIZATION OF FINISHES / PERSONALIZZAZIONE DELLE FINITURE



Possibility, for minimum quantities, to choose the finish of the frame.  
Possibilità, per quantitativi minimi, di scegliere la finitura della struttura.

Customised finishing or RAL colour chosen by the customer  
Finitura personalizzata o RAL scelto dal cliente

## CAMBIO FINITURA PARALUME / CHANGE SHADE FINISH

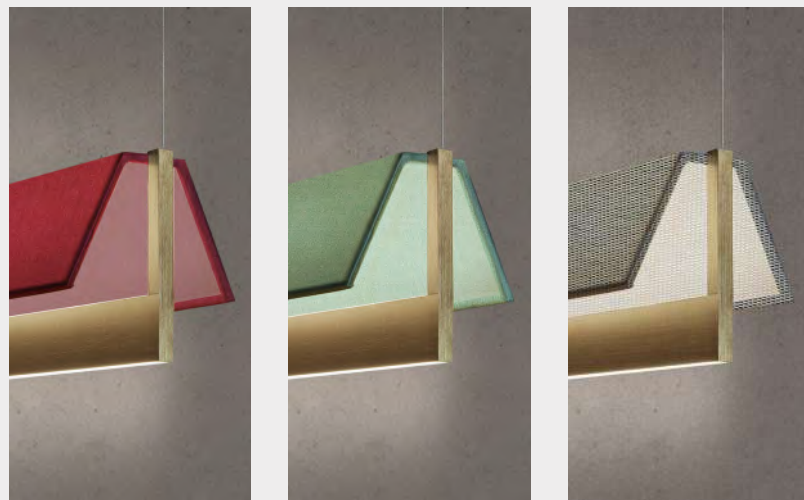

The lampshade, which tops the Fly suspension, can be customized with different fabrics or materials.  
Il paralume, che sovrasta Fly sospensione, può essere personalizzato con tessuti o materiali differenti.

Customised fabric colour chosen by the customer  
Tessuto da campionario Contardi o scelto dal cliente

## LENGTH CUSTOMIZATION / PERSONALIZZAZIONE DELLE LUNGHEZZE

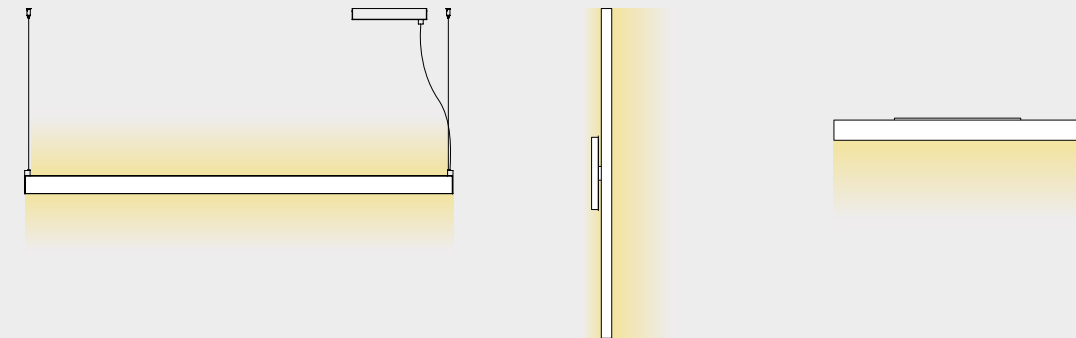

suspension / sospensione

wall / parete

picture / picture

Fly lends itself to being specified in various projects as it is possible to request custom lengths, different from those available in the catalog.

Customizations always require a minimum quantity.

Fly si presta ad essere specificata in diversi progetti in quanto è possibile chiedere lunghezze speciali, differenti da quelle presenti a catalogo.

Le personalizzazioni richiedono sempre un quantitativo minimo di pezzi.

## LIGHT SOURCE AND EMISSION / FONTE LUMINOSA ED EMISSIONE

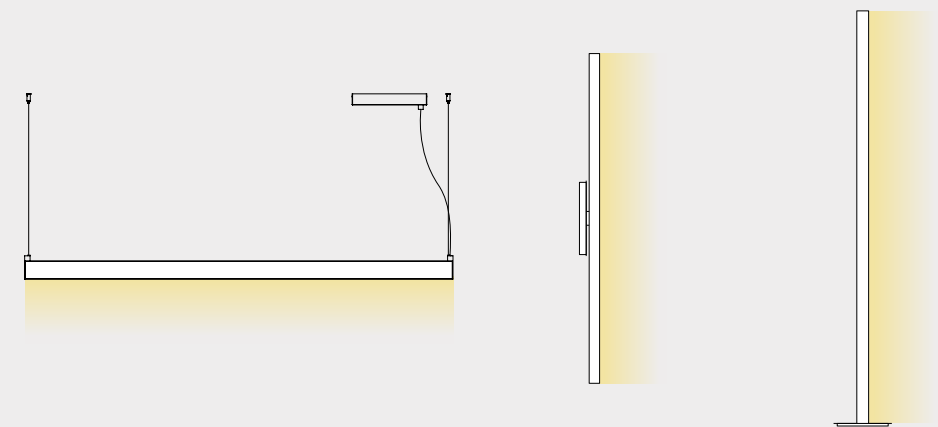

suspension / sospensione

wall / parete

floor / piantana

It is possible to request Fly suspension, wall, and floor versions with single emission, instead of the standard bi-emission, for minimum order quantities.

Possibilità di richiedere Fly sospensione, da parete e piantana con mono-emissione, anziché standard con bi-emissione, per quantitativi minimi.



# — g+t

DESIGN JAN VAN LIERDE

G+T represents the pinnacle of innovation and quality in Contardi's reading lamps, designed for exclusive spaces such as yachts, hotels, and prestigious boutiques. The head, inspired by cocktail dispenser design, rests on a flexible brass arm covered in braided leather. Ideal for accompanying reading moments in any context, G+T is available in fixed wall, pendant, and battery versions with a magnetic attachment for great versatility.

G+T è l'apice dell'innovazione e della qualità nel campo delle lampade da lettura Contardi progettata per spazi esclusivi come yachts, hotel e boutique di prestigio. La testa ispirata al design dei dosatori per cocktail si posa su braccio flessibile in ottone rivestito di cuoio intrecciato. Ideale per accompagnare il momento della lettura in ogni contesto, G+T è disponibile oltre che nella versione a parete, anche a sospensione e a batteria con attacco magnetico, per una grande versatilità di utilizzo.

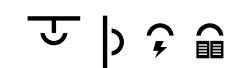

G+T battery, reading light, satin bronze frame and dark brown braided leather arm.

Lampada da lettura, G+T battery, struttura bronzo spazzolato, braccio in pelle intrecciata marrone testa di moro.





The G+T wired wall lamp includes an integrated USB port, suitable for charging electronic devices like smartphones and tablets, adding extra functionality and convenience.

G+T a parete cablata include una porta USB integrata, ideale per ricaricare dispositivi elettronici come smartphone e tablet, offrendo funzionalità aggiuntiva e praticità.

G+T wall light, wired version, polished nickel frame and dark brown braided leather arm.  
Lampada da parete G+T, versione cablata, struttura nickel lucido, braccio in pelle intrecciata marrone testa di moro.



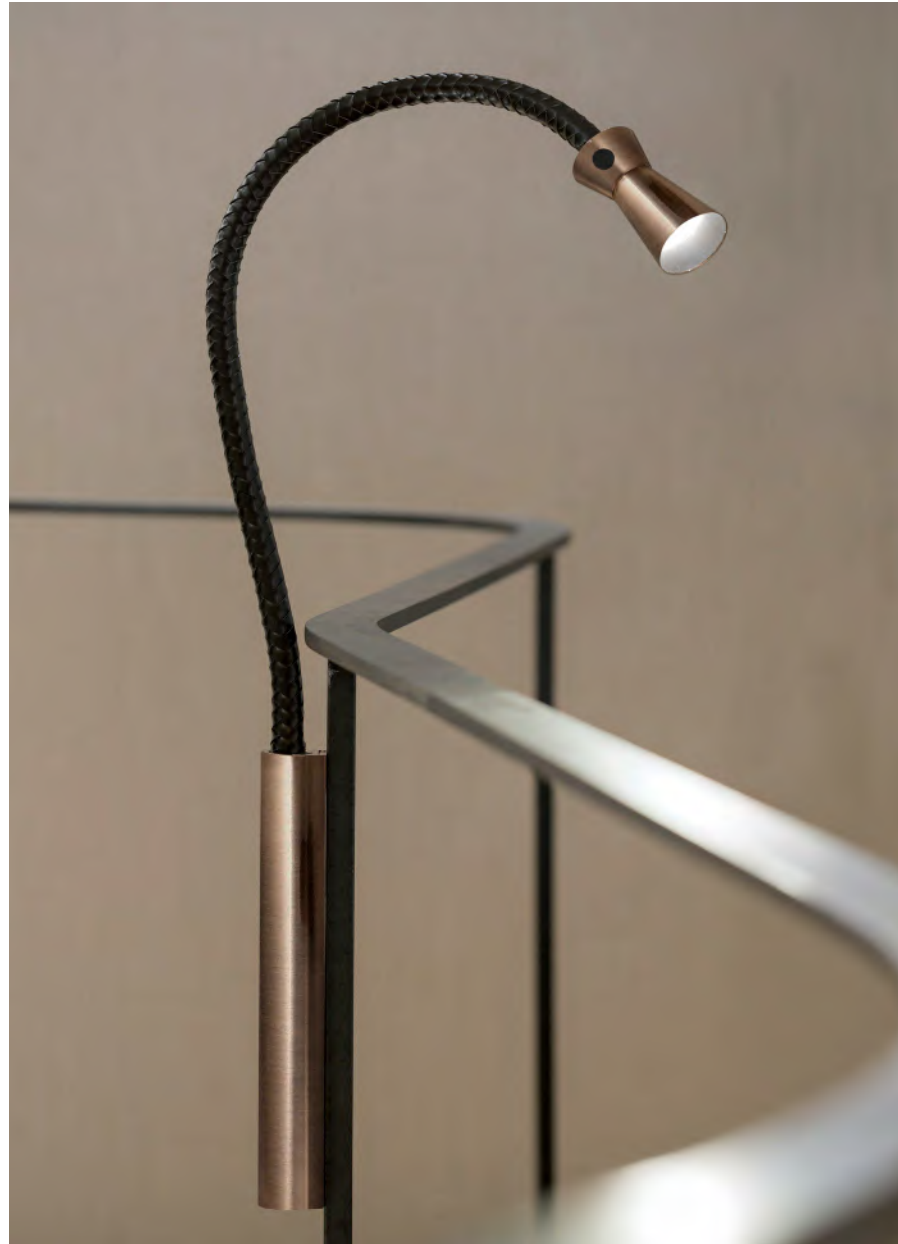

Innovative reading lamp. Battery-operated, portable, luxurious, with a magnetic detail which allows it to be placed to iron metal surfaces. G+T Battery is rechargeable via USB type-C port. It features three light intensity levels (100 - 70 - 30%) with a switch control located on the head.

Lampada da lettura innovativa. A batteria, portatile, di lusso, con dettaglio magnetico che la rende applicabile a superfici metalliche ferrose. G+T Battery è ricaricabile tramite porta USB di tipo C. Caratterizzata da tre livelli di intensità luminosa (100 - 70 - 30%) con controllo a interruttore, posizionato sulla testa.



G+T Battery is supported by a wall **fixing accessory**.  
G+T Battery sostenuta dall'accessorio per **fissaggio a parete**.



Wall fixing accessory.  
Fissaggio per parete.



Seats and sofas fixing accessory.  
Fissaggio per poltrone e divani.



G+T Battery is supported by an accessory for fixing to seats and sofas.  
G+T Battery sostenuta dall'accessorio per fissaggio su poltrone e divani.



Table fixing accessory.  
Fissaggio per tavolo.

G+T Battery is supported by a table fixing accessory.  
G+T Battery sostenuta dall'accessorio per fissaggio al tavolo.



G+T Reading detail, polished nickel finish.  
Dettaglio G+T Reading, finitura nickel lucido.



G+T Reading, matt black silk lacquered finish.  
G+T Reading, lampada da lettura, finitura laccato nero seta opaco.



G+T suspension lamp, with a diffuser detail inspired by the cocktail measurer: the jigger.  
 G+T sospensione, dettaglio del diffusore ispirato al dosatore dei cocktail: jigger.

G+T suspension, polished nickel finish with dark brown braided leather frame.  
 G+T sospensione, finitura nickel lucido con struttura in pelle intrecciata marrone testa di moro.

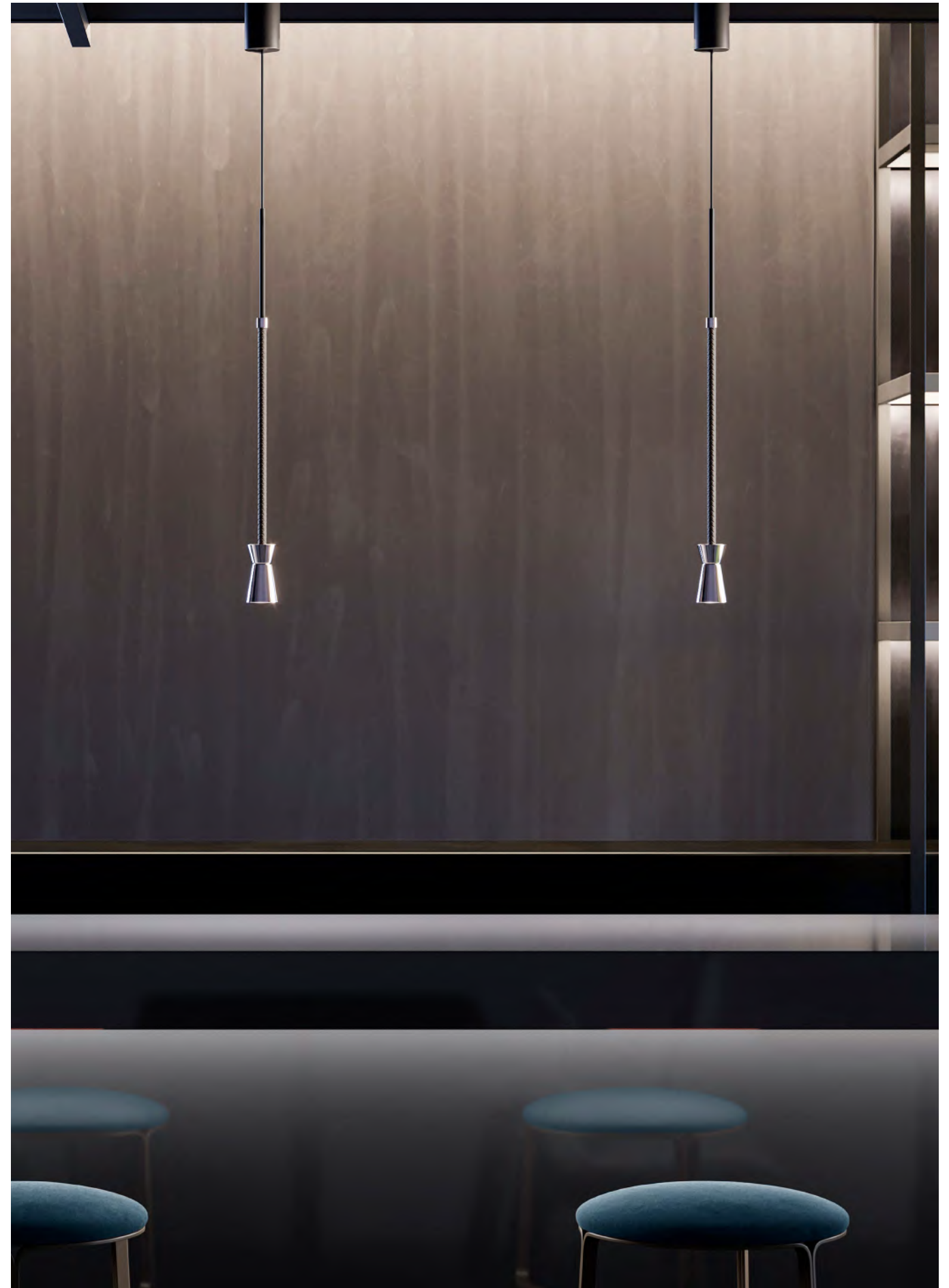

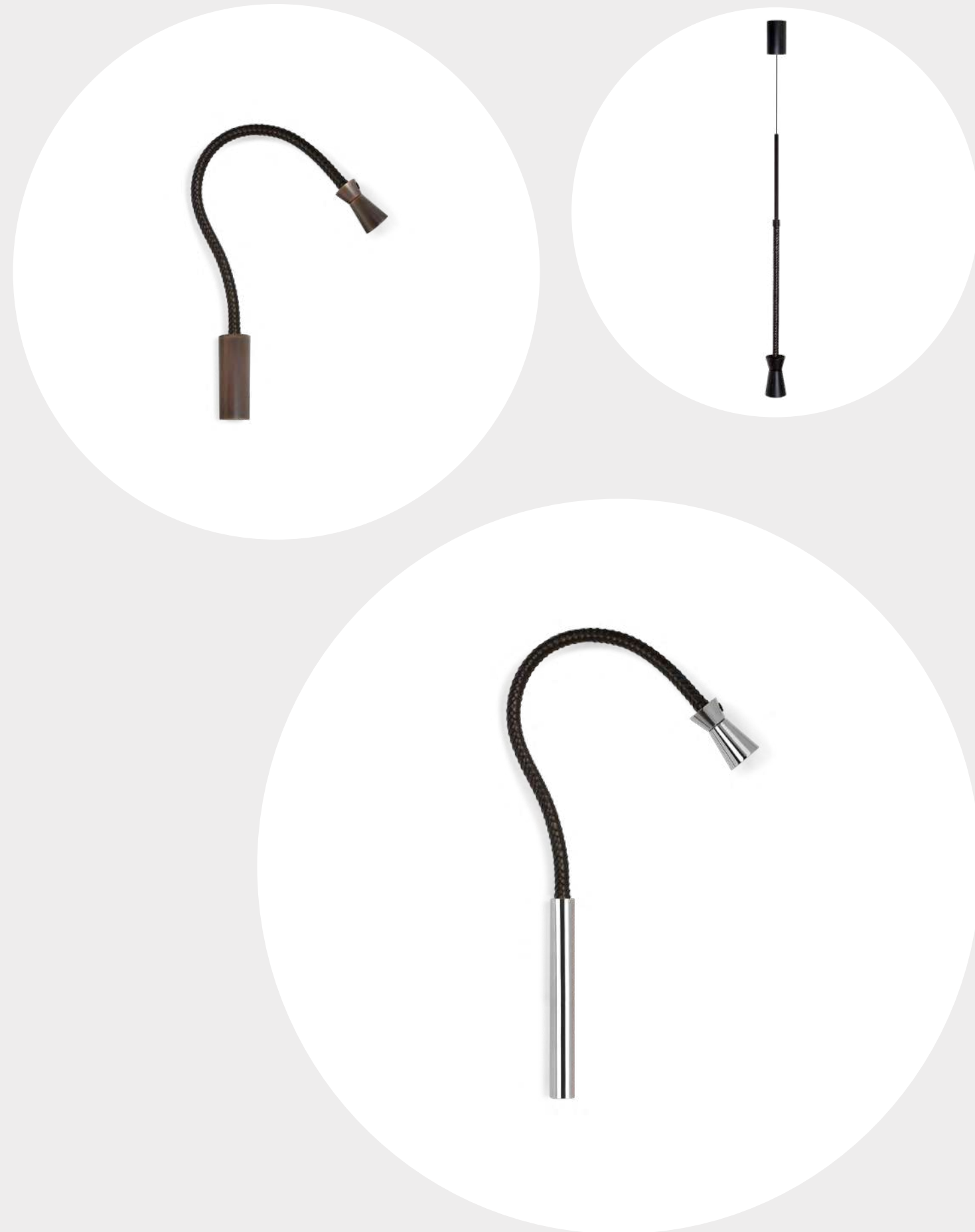

g+t

IP20

SUSPENSION / SOSPENSIONE

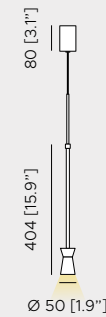

WALL / PARETE



BATTERY

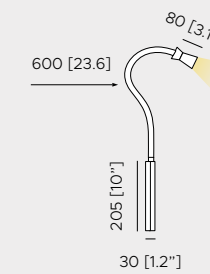

WALL

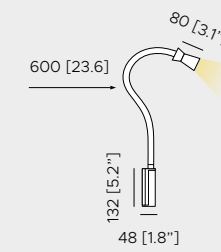

READING

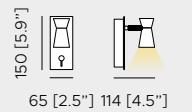

Three intensity level control on the head.  
Comando a tre livelli di intensità sulla testa.

G+T BATTERY ACCESSORIES / ACCESSORI G+T BATTERY

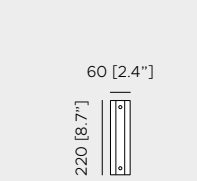

WALL FIXING / FISSAGGIO A PARETE

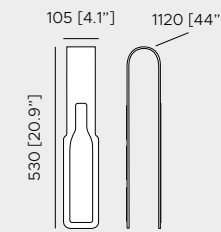

SEATS & SOFA FIXING / FISSAGGIO POLTRONE E DIVANI



TABLE FIXING / FISSAGGIO AL TAVOLO

Minimum opening 10 mm [0.4"]  
Maximum opening 40 mm [1.5"]  
Apertura minima 10 mm [0.4"]  
Apertura massima 40 mm [1.5"]

BATTERY

Autonomy: 8 hours  
Life cycles: 600  
Charging time: 5/6 hours  
USB cable type C supplied, power supply not supplied

BATTERIA

Autonomia: 8 ore  
Cicli di vita: 600  
Tempo di ricarica: 5/6 ore  
Cavo USB tipo C fornito, alimentatore non fornito

LIGHT SOURCE / FONTE LUMINOSA

220-240V · 110V  
1x3 W LED module · 500 Lm  
2700 K · CRI >90

SWITCH / INTERRUOTTORE

WALL - BATTERY / PARETE - BATTERIA  
three intensity level control on the head / comando a tre livelli di intensità sulla testa

READING

ON-OFF switch / interruttore ON-OFF

FINISHES / FINITURE

base and diffuser / base e diffusore  
WALL - BATTERY

- satin bronze  
bronzo spazzolato
- polished nickel  
nickel lucido

READING - SUSPENSION

- polished nickel  
nickel lucido
- matt black silk lacquered  
laccato nero seta opaco

frame / struttura

WALL - BATTERY - SUSPENSION

- dark brown braided leather  
pelle intrecciata marrone testa di moro

CABLE / CAVO

2000mm [79.7"] standard

SUSPENSION / SOSPENSIONE

- black colour fabric  
tessuto color nero

extra cable / cavo extra

up to 5000 mm [196.8"] on demand / fino a 5000 mm [196.8"] su richiesta  
up to 10000 mm [393.7"] on demand / fino a 10000 mm [393.7"] su richiesta



# — kiki

DESIGN CONTARDI STUDIO

Kiki is a light with a pop and contemporary design, available in pendant, ceiling wall and table versions. Made of metal with elegant finishes, it offers a white opal glass diffuser for soft and even light. In its modular use, both in pendant and wall versions, it allows for great decorative opportunities, thanks to the different accessories and inputs that allow multiple configurations. Perfect for projects requiring creative and unexpected lighting solutions.

Kiki è una luce dal design pop e contemporaneo, in versioni a sospensione, plafone, a parete e da tavolo. Realizzata in metallo con eleganti finiture, offre un diffusore in vetro opale bianco per una luce morbida e uniforme. Nel suo utilizzo modulare sia a sospensione che a parete consente grandi opportunità decorative anche grazie ai diversi accessori e ingressi che consentono molteplici configurazioni. Perfetta per progetti che richiedono soluzioni illuminotecniche creative e inaspettate.

Kiki connect, wall light system,  
satin golden nickel frame,  
opal glass diffuser and orange cable.

Kiki connect, sistema di lampade a parete,  
struttura nickel dorato satinato,  
diffusore in vetro opale e cavo arancione.

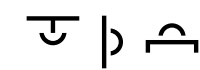



Kiki Connect, cable with plug detail.  
Kiki connect, dettaglio cavo con spina.

Kiki Connect, wall and ceiling application,  
satin golden nickel frame, opal glass diffuser and black cable.  
Kiki connect, applicazione a parete e plafone,  
struttura nickel dorato satinato, diffusore in vetro opale e cavo nero.







Kiki wall light, satin golden nickel finish,  
opal glass diffuser.  
Kiki, lampada a parete, finitura nickel dorato  
satinato con diffusore in vetro opale.

Kiki, wall lamp, version with IP44 protection rating,  
satin golden nickel finish, opal glass diffuser.  
Kiki, lampada a parete, versione con grado di protezione IP44,  
finitura nickel dorato satinato con diffusore in vetro opale.





Kiki wall lights and suspension cluster  
in different heights.  
Lampade a parete e cluster di  
sospensioni a diverse altezze.



Kiki suspension lamps, satin golden nickel frame and opal white diffuser.  
 Kiki, lampade a sospensione, struttura nickel dorato satinato e diffusore bianco opale.



Kiki spiral cluster.  
 Cluster a spirale Kiki.



Cluster, concentrically arranged kiki suspensions, 64 pieces on three levels.  
Cluster di sospensioni kiki disposte in modo concentrico, 64 pezzi su tre livelli.



Kiki table lamp, satin golden nickel finish and opal white diffuser.  
Lampada da tavolo Kiki, finitura nickel dorato satinato e diffusore bianco opale.

# kiki

IP20 · IP44



**SUSPENSION / SOSPENSIONE**

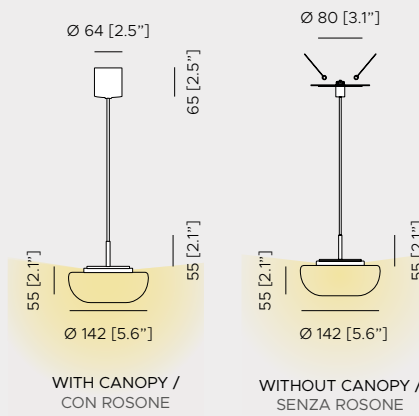

**WALL / PARETE**

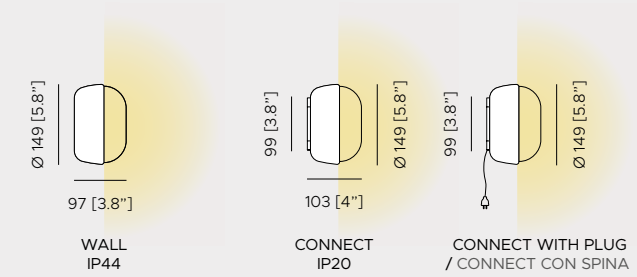

**TABLE / TAVOLO**

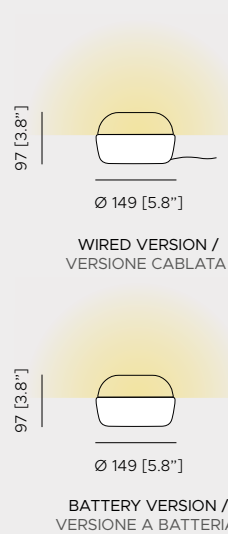

**LIGHT SOURCE / FONTE LUMINOSA**

**220-240V - 110V**  
1x5 W Custom LED · 550 Lm  
2700 K · CRI >90

**SWITCH / INTERRUTTORE  
TABLE / TAVOLO**

sensor control on the diffuser / comando sensoriale sul diffusore

**DIMMING / DIMMERAZIONE  
WALL - SUSPENSION /  
PARETE - SOSPENSIONE**

phase cut · Triac / taglio di fase · Triac  
1-10V · DALI on demand / 1-10V · DALI su richiesta

**TABLE / TAVOLO**

dimmable / dimmerabile

**ACCESSORIES / ACCESSORI**

**CONNECT**  
kit cable + tensioner / kit cavo + tendicavo

KIT 1: 1500 mm [59\"/>

**MATERIALS / MATERIALI**  
frame / struttura

● anthracite / antracite ● brushed bronze-nickel / bronzo-nickel spazzolato ● satin golden nickel / nickel dorato satinato

diffuser / diffusore

● matt white lacquered - **KIKI WALL - CONNECT ONLY** / laccato bianco opaco - **SOLO PER KIKI PARETE - CONNECT**  
● satin opal glass / vetro bianco opale

**CABLE / CAVO  
KIKI CONNECT**

**KIKI SUSPENSION**  
2000mm [79.7\"/>

extra cable / cavo extra

● orange colour fabric / tessuto color arancio ● sand colour fabric / tessuto color sabbia ● black colour fabric / tessuto color nero  
● transparent steel / acciaio trasparente

up to 5000 mm [196.8\"/>

# kiki



## SUSPENSION COMPOSITIONS / COMPOSIZIONI SOSPENSIONE

### ROUND CLUSTERS / CLUSTER ROTONDI

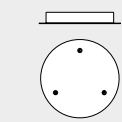

Ø300 mm [11.8"]  
3 SUSPENSIONS  
3 SOSPENSIONI

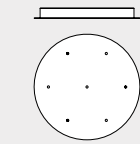

Ø570 mm [22.4"]  
7 SUSPENSIONS  
7 SOSPENSIONI

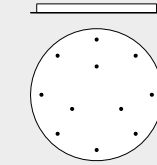

Ø700 mm [27.5"]  
11 SUSPENSIONS  
11 SOSPENSIONI

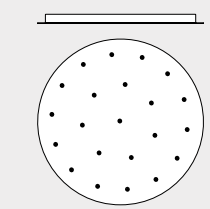

Ø900 mm [35.4"]  
22 SUSPENSIONS  
22 SOSPENSIONI

### LINEAR CLUSTERS / CLUSTER LINEARI

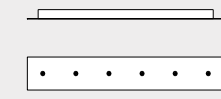

L.1000 mm [39.3"]  
UP TO 6 SUSPENSIONS  
FINO A 6 SOSPENSIONI

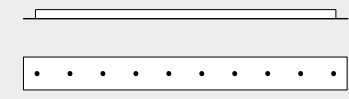

L.1300 mm [51.2"]  
UP TO 10 SUSPENSIONS  
FINO A 10 SOSPENSIONI

## WALL-CEILING COMPOSITION / COMPOSIZIONE A PARETE-PLAFONE

### KIKI CONNECT ACCESSORY / ACCESSORIO KIKI CONNECT



CABLE DECENTRALIZE  
BLOCCACAVO PER DECENTRAMENTO

### KIKI CONNECT COMPOSITION EXAMPLES / ESEMPI COMPOSIZIONI KIKI CONNECT

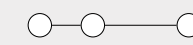

LINEAR COMPOSITION /  
COMPOSIZIONE LINEARE

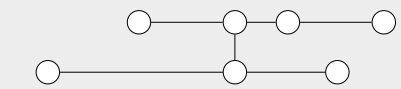

MULTIPLE LINEAR COMPOSITION /  
COMPOSIZIONE LINEARE MULTIPLA

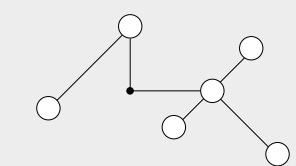

IRREGULAR COMPOSITION /  
COMPOSIZIONE IRREGOLARE

Driver on board compatible with phase cut/Triac - Possibility of creating infinite compositions from a single electrical output. Cable outlet at 45°. Possibility of connection to the socket with plug and switch control. Maximum of 4 outputs per lamp.

Driver a bordo compatibile con taglio di fase/Triac - Possibilità di composizioni potenzialmente infinite da una sola uscita elettrica. Uscita dei cavi ogni 45°. Possibilità di collegamento alla presa di corrente con spina e comando tramite interruttore. Massimo 4 uscite per lampada.



# — manhattan

DESIGN CONTARDI STUDIO

Manhattan is the symbol of metropolitan elegance, with a design that moves fluidly on three axes: base, arms, and head. Made of high-quality brass, it combines sophisticated aesthetics with robust functionality. Perfect for hospitality and modern residential spaces, it offers controlled lighting adaptable to specific needs. Available in two different finishes, Manhattan stands out for its balance between style and advanced engineering.

Manhattan è il simbolo dell'eleganza metropolitana, con un design che si muove fluidamente su tre assi: base, bracci e testa. Realizzata in ottone di alta qualità, combina un'estetica sofisticata con una funzionalità robusta. Perfetta per l'hospitality e spazi residenziali moderni, offre una luce controllata e adattabile alle esigenze specifiche. Disponibile in due diverse finiture, Manhattan si distingue per il suo equilibrio tra stile e ingegneria avanzata.



Manhattan, reading light, satin nickel finish with switch.  
Lampada a lettura Manhattan, finitura nickel satinato con interruttore.





open / apri



turn / ruota



close / chiudi

Manhattan, a reading lamp with dual horizontal movement on the arm and a rotating head. Available with or without switch.  
Manhattan, lampada da lettura con doppio movimento orizzontale sul braccio e rotativo sulla testa. Disponibile con o senza interruttore.

Reading light, satin bronze finish, without switch.  
Lampada da lettura, finitura bronzo spazzolato, senza interruttore.



# manhattan

IP20

SUSPENSION / SOSPENSIONE

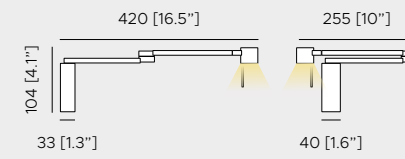

LIGHT SOURCE / FONTE LUMINOSA

**220-240V · 110V**  
1x3 W LED module - 500 Lm  
2700 K - CRI >90

FINISHES / FINITURE  
frame / struttura

- satin bronze  
bronzo spazzolato
- satin nickel  
nickel satinato





# — melanocetus

DESIGN TRISTAN AUER

Tristan Auer described it as his "dream lamp," with an unmistakable Parisian style and a solemn presence. Its essential and pure lines bring balance and grace to any space. The fixed and steady upper light combines with the adjustable lower light, creating a play of lights that transforms the space into one of beauty and harmony.

Tristan Auer l'ha definita la sua "lampada dei sogni", con uno stile parigino inconfondibile e una presenza solenne. Le sue linee essenziali e pure infondono equilibrio e grazia a ogni spazio. La luce superiore, fissa e costante, si unisce a quella inferiore, orientabile, creando un gioco di luci che trasforma l'ambiente in uno luogo di bellezza e armonia.

Melanocetus, ceiling lamp,  
lacquered gold finish with black detail.  
Lampada a plafone Melanocetus,  
finitura laccato oro con dettagli nero opaco.

h



Detail of adjustable spotlight and fixed upward spotlight.  
Dettaglio faretto orientabile e faretto fisso verso l'alto.

Melanocetus suspension, double version,  
matt black silk lacquered with lacquered gold details.  
Sospensione Melanocetus, versione double,  
laccato nero seta opaco con dettagli laccati oro.



# melanocetus

IP20



**CEILING / PLAFONE**



**CEILING**

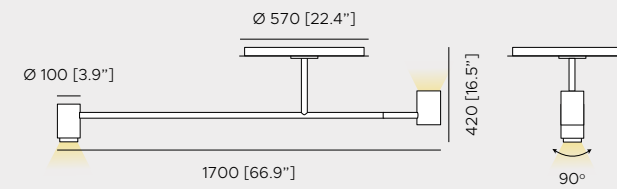

**DOUBLE CEILING**

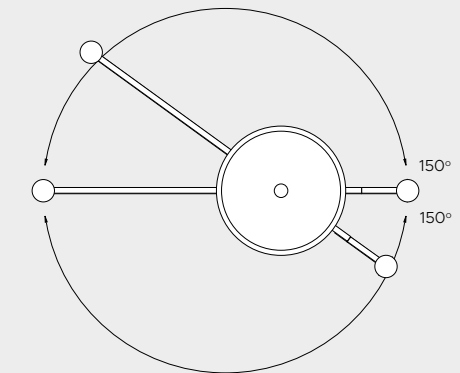
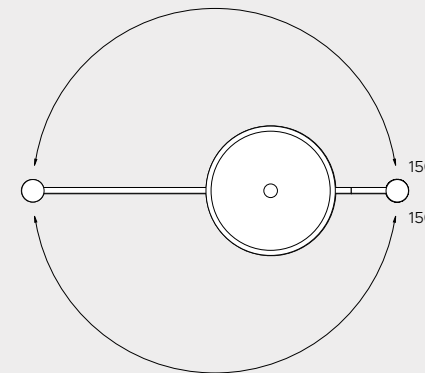
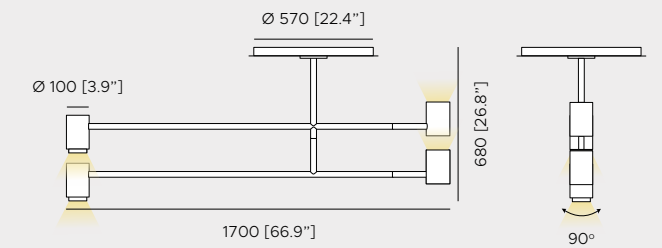

**LIGHT SOURCE / FONTE LUMINOSA**

**220-240V · 110V**

**CEILING / PLAFONE**

2x7.5 W GU10 · 2 x 650 Lm  
 dimmable LED bulbs included / lampadine LED dimmerabili incluse  
 3000 K · CRI >90

**DOUBLE CEILING / PLAFONE DOPPIA**

4x7.5 W GU10 · 4 x 650 Lm  
 dimmable LED bulbs included / lampadine LED dimmerabili incluse  
 3000 K · CRI >90

**DIMMING / DIMMERAZIONE**

compatible with remote control systems when dimmable LED bulbs are used /  
 compatibile con sistemi di controllo remoto in caso di utilizzo di lampadine LED dimmerabili

**FINISHES / FINITURE**

frame / struttura

● lacquered gold  
 oro laccato

● matt black lacquered  
 laccato nero opaco

● matt black lacquered details  
 dettaglio laccato nero opaco

● lacquered gold details  
 dettaglio oro laccato

diffuser / diffusore

● satin plexiglass  
 plexiglass satinato





# — mikado

DESIGN MASSIMILIANO RAGGI

Mikado is a luminous work of art, with finely decorated crystals shaped using artisanal molds that enhance the beauty of the materials. Available in both pendant and wall versions, its crystals reflect and refract light, creating surprising plays of light. Adaptable to any project style, Mikado stands out for its exclusive design.

Mikado è un'opera d'arte luminosa, con cristalli finemente decorati e plasmati tramite stampi artigianali che esaltano la bellezza dei materiali. Disponibile nelle versioni a sospensione e applique, i suoi cristalli riflettono e rifrangono i raggi creando sorprendenti giochi di luce. Adattabile a ogni stile di progetto, Mikado si distingue per il suo design esclusivo.



Mikado single suspension, satin brass finish with crystal diffusers.  
Sospensione singola Mikado, finitura ottone satinato con diffusori in cristallo.



Mikado double suspension, satin brass finish with engraved and prismatic crystal diffusers.  
Sospensione doppia Mikado, finitura ottone satinato con diffusori in cristallo inciso o prismatico.



Mikado wall light solo/2.  
Lampada a parete Mikado solo/2.

Mikado wall light.  
Versione a parete Mikado.





# mikado

IP20



SUSPENSION / SOSPENSIONE



SINGLE



DOUBLE

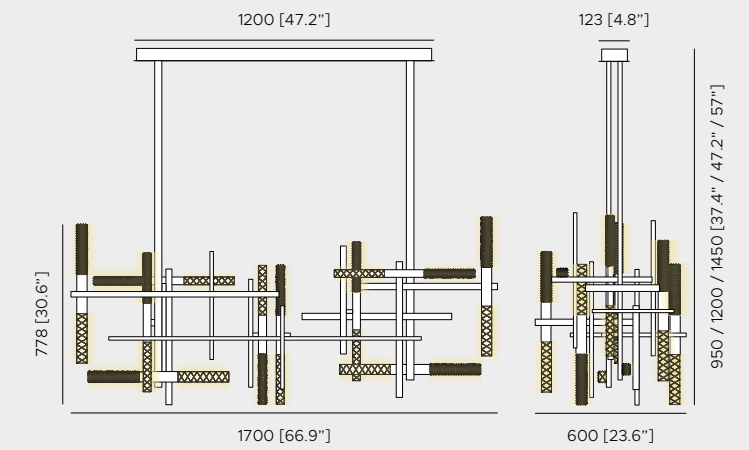
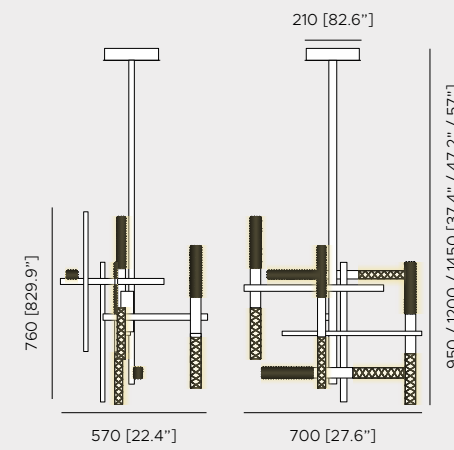

LIGHT SOURCE / FONTE LUMINOSA

**220-240V · 110V**  
**SINGLE / SINGOLA**  
 10x4 W LED module · 5600 Lm  
 3000 K · CRI >90

**DOUBLE / DOPPIA**  
 20x4 W LED module · 11200 Lm  
 3000 K · CRI >90

DIMMING / DIMMERAZIONE

phase cut (Triac) / taglio di fase (Triac)  
 1-10V · DALI on demand / 1-10V · DALI su richiesta

FINISHES / FINITURE

diffuser / diffusore

 satin brass  
 ottone satinato

 transparent engraved crystal  
 cristallo trasparente inciso

 transparent prismatic crystal  
 cristallo trasparente prismatico

SPECIAL HEIGHTS / ALTEZZE SPECIALI

minimum height: 850mm [334.6"] / altezza minima: 850mm  
 maximum height: 2400mm [944.8"] / altezza massima: 2400mm

# mikado

IP20

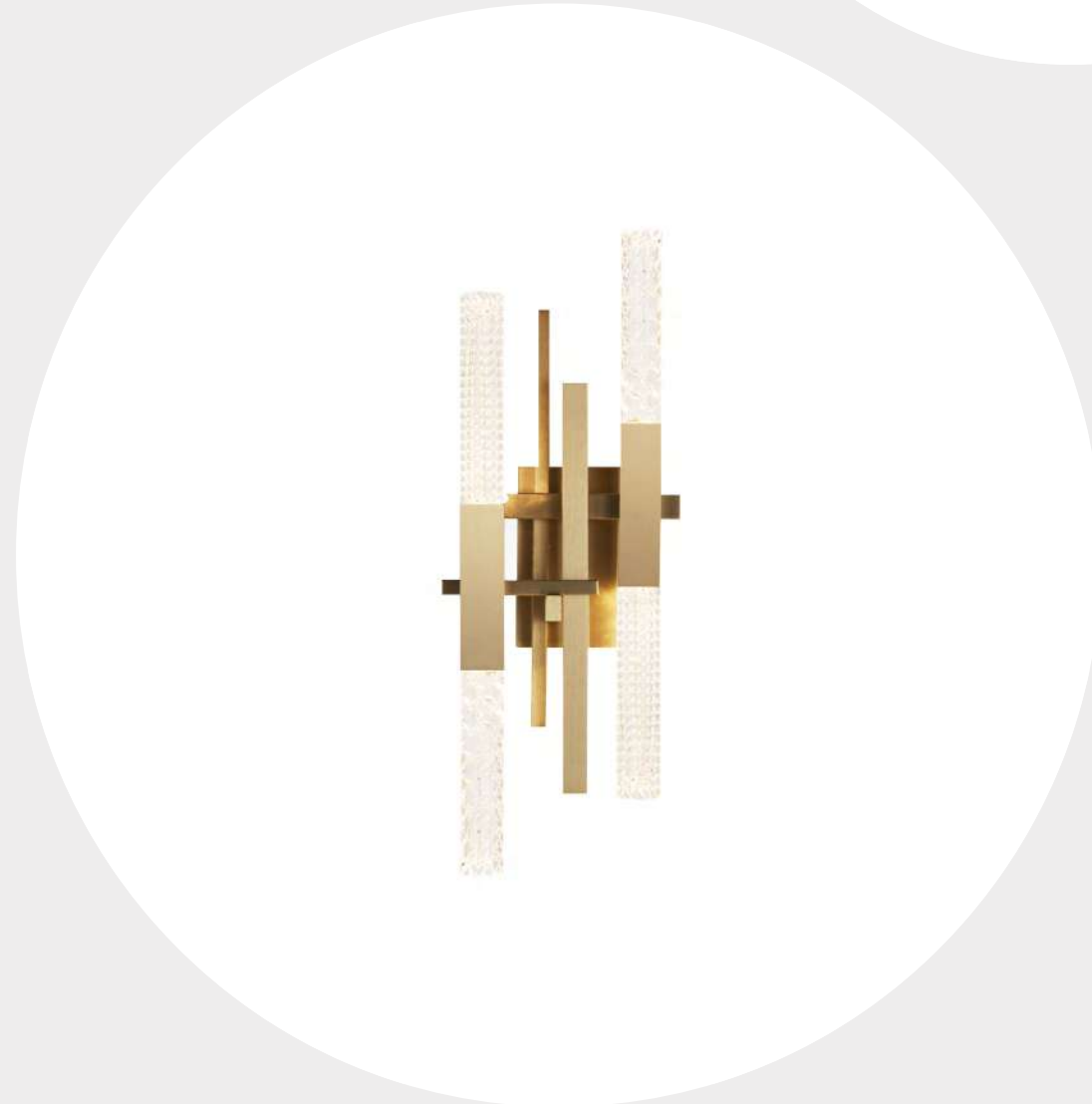
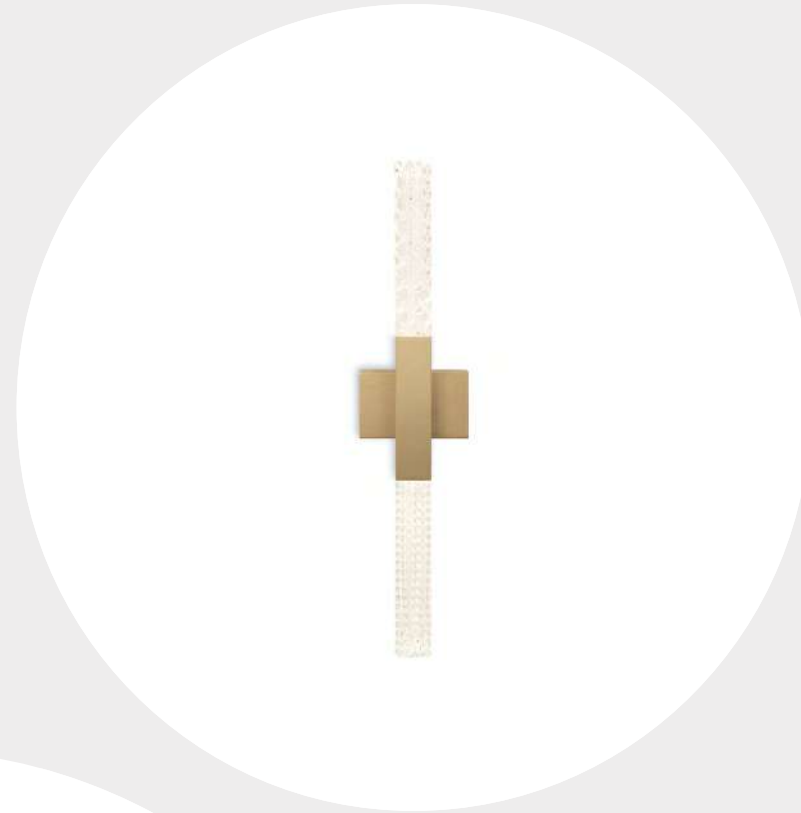

**WALL / PARETE**



SOLO/2

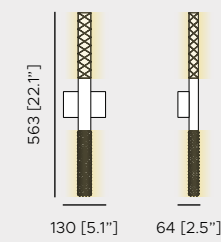

WALL

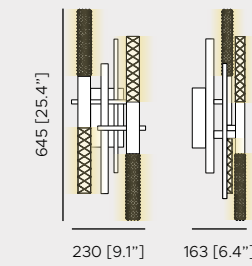

**LIGHT SOURCE / FONTE LUMINOSA**

**220-240V · 110V**

**SOLO/2**

2x4 W LED module · 1120 Lm  
3000 K · CRI >90

**WALL / PARETE**

4x4 W LED module · 2240 Lm  
3000 K · CRI >90

**DIMMING / DIMMERAZIONE**

phase cut (Triac) / taglio di fase (Triac)  
1-10V · DALI on demand / 1-10V · DALI su richiesta

**FINISHES / FINITURE**

frame / struttura

 satin brass  
ottone satinato

diffuser / diffusore

 transparent engraved crystal  
cristallo trasparente inciso

 transparent prismatic crystal  
cristallo trasparente prismatico



# — ovale e tonda

DESIGN CONTARDI STUDIO

Ovale e Tonda embrace Contardi's "White Shirt" philosophy with its tailored design. Both collections excel in their absolute simplicity, while remaining the most stylish decorative solution, like a white shirt crafted by a skilled tailor, timelessly suited for residential, commercial, and hospitality settings.

Ovale e Tonda riprendono la filosofia della "Camicia Bianca" di Contardi nel suo taglio sartoriale. Entrambe le collezioni vincono per la loro assoluta semplicità ma rimangono anche la soluzione decorativa più di stile, come una camicia bianca confezionata dalle mani sapienti di un sarto, che rimane nel tempo adatta al residenziale, commerciale e hospitality.

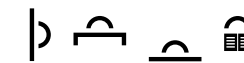

Ovale table lamp, matt light satin bronze frame with white cotton shade.

Lampada da tavolo Ovale, struttura bronzo spazzolato chiaro opaco con paralume in cotone bianco.



Shade detail of the Ovale collection.  
Dettaglio paralume della collezione Ovale.

Ovale floor lamp, matt light satin bronze frame  
with white cotton shade.  
Lampada da terra Ovale, struttura bronzo spazzolato chiaro opaco  
con paralume in cotone bianco.





Tonda, table lamp and wall lamp  
with integrated adjustable LED spotlight.  
Tonda, lampada da tavolo e lampada da  
parete con faretto LED orientabile integrato.



Tonda Liseuse, floor lamp, matt black silk lacquered frame, and white cotton shade.  
Tonda Liseuse, lampada da terra, struttura laccato nero seta opaco, paralume in cotone bianco.



Tonda floor lamp and table lamp "desk" version, matt light satin bronze frame and white cotton shades.  
Tonda lampada da terra e lampada da tavolo versione "desk", struttura bronzo spazzolato chiaro opaco con paralumi in cotone bianco.

# ovale

IP20



**TABLE / TAVOLO**



**SMALL**

**LARGE**

**FLOOR / TERRA**



**FLOOR**

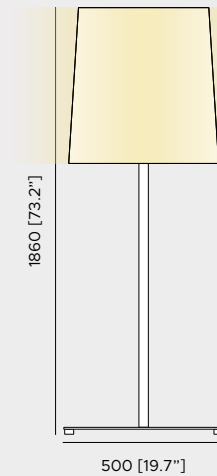
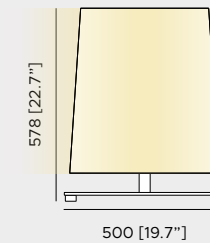
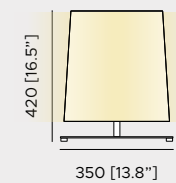

**LIGHT SOURCE / FONTE LUMINOSA**

**220-240V**  
**SMALL**  
1x10 W E27  
LED light bulb / lampadina LED

**110V**  
**SMALL**  
1x10 W E26  
LED light bulb / lampadina LED

**LARGE**  
1x13 W E27  
LED light bulb / lampadina LED

**LARGE**  
1x13 W E26  
LED light bulb / lampadina LED

**FLOOR / TERRA**  
1x14 W E27  
LED light bulb / lampadina LED

**FLOOR / TERRA**  
1x14 W E26  
LED light bulb / lampadina LED

**SWITCH / INTERRUTTORE**

ON-OFF switch on cable / interruttore ON-OFF su cavo

**DIMMING / DIMMERAZIONE**

**TABLE / TAVOLO**  
dimmer switch on the cable available on demand, compatible with dimmable LED light bulbs only / disponibile su richiesta versione con dimmer su cavo, compatibile solo con lampadine LED dimmerabili

**FLOOR / TERRA**  
foot dimmer available on demand, compatible with dimmable LED light bulbs only / disponibile su richiesta, versione con dimmer a piede, compatibile solo con lampadine LED dimmerabili

**FINISHES / FINITURE**  
frame / struttura

 matt light satin bronze  
bronzo spazzolato chiaro opaco

 matt black silk lacquered  
laccato nero seta opaco

shade / paralume

 white cotton  
cotone bianco

**CABLE / CAVO**  
2000mm [79.7"] +  
300mm [11.8"] standard

 black colour fabric  
tessuto color nero

# tonda

IP20



**WALL / PARETE**



**WALL**

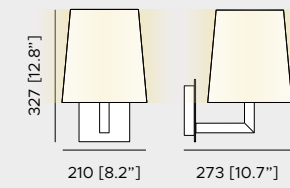

**LED**

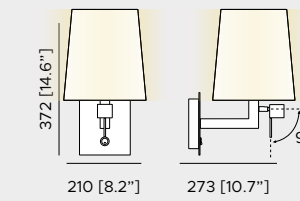

**LIGHT SOURCE / FONTE LUMINOSA**

**220-240V**  
**WALL / PARETE**  
 1x10 W E27  
 LED light bulb / Lampadina LED

**110V**  
**WALL / PARETE**  
 1x10 W E26  
 LED light bulb / Lampadina LED

**LED / LED**  
 1x10 W E27 LED light bulb / Lampadina LED  
 + 1x3 W LED module · 550 Lm  
 2.700 K · CRI >90

**LED / LED**  
 1x10 W E26 LED light bulb / Lampadina LED  
 + 1x3 W LED module · 550 Lm  
 2.700 K · CRI >90

**DIMMING / DIMMERAZIONE**

compatible with remote control system when dimmable LED bulbs are used  
 compatibile con sistemi di controllo remoto con lampadine LED dimmerabili

**FINISHES / FINITURE**  
 frame / struttura

 matt light satin bronze  
 bronzo spazzolato chiaro opaco

 matt black silk lacquered  
 laccato nero seta opaco

shade / paralume

 white cotton  
 cotone bianco



# tonda

IP20

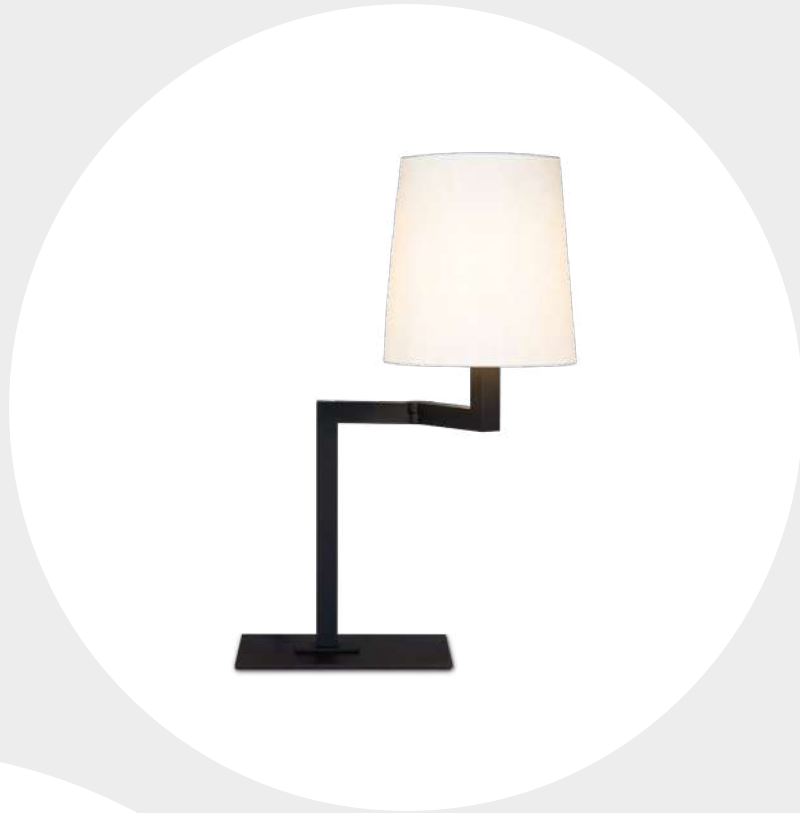

**TABLE / TAVOLO**



TABLE



DESK

**FLOOR / TERRA**



FLOOR



LISEUSE

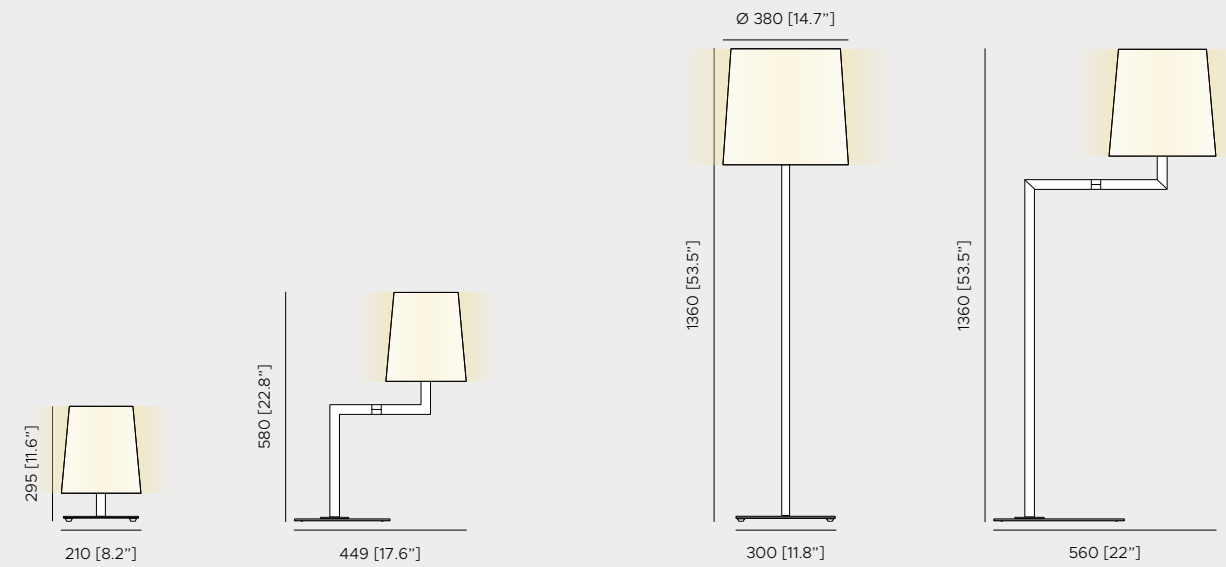

**LIGHT SOURCE / FONTE LUMINOSA**

**220-240V**  
**TABLE / TAVOLO**  
 1x10 W E27  
 LED light bulb / Lampadina LED

**DESK / DESK**  
 1x12 W E27  
 LED light bulb / Lampadina LED

**FLOOR - LISEUSE / TERRA - LISEUSE**  
 1x14 W E27  
 LED light bulb / Lampadina LED

**110V**  
**TABLE / TAVOLO**  
 1x10 W E26  
 LED light bulb / Lampadina LED

**DESK / DESK**  
 1x12 W E26  
 LED light bulb / Lampadina LED

**FLOOR - LISEUSE / TERRA - LISEUSE**  
 1x14 W E26  
 LED light bulb / Lampadina LED

**SWITCH / INTERRUTTORE**

ON-OFF switch on cable / interruttore ON-OFF su cavo

**DIMMING / DIMMERAZIONE**

**TABLE / TAVOLO**  
 dimmer switch on the cable available on demand, compatible with dimmable LED light bulbs only / disponibile su richiesta versione con dimmer su cavo, compatibile solo con lampadine LED

**FLOOR - LISEUSE / TERRA - LISEUSE**  
 foot dimmer available on demand, compatible with dimmable LED light bulbs only / disponibile su richiesta versione con dimmer a piede, compatibile solo con lampadine LED dimmerabili

**FINISHES / FINITURE**  
 frame / struttura

matt light satin bronze  
 bronzo spazzolato chiaro opaco

matt black silk lacquered  
 laccato nero seta opaco

shade / paralume

white cotton  
 cotone bianco

**CABLE / CAVO**  
 2000mm [79.7"] +  
 300mm [11.8"] standard

black colour fabric  
 tessuto color nero



# — solitario

DESIGN MARCELLO COLLI & MAURIZIO DI MAURO

Solitario is a product that makes customization immediate and natural.

The main body, which contains the LED light source, is the core of the entire collection. Combined with different types of accessories, it creates numerous usage possibilities, offering a variety of options for residential or commercial projects. Solitario can easily transition from modern to a more decorative environment, depending on the chosen finish and composition.

Solitario è un prodotto che rende la personalizzazione immediata e naturale.

Il corpo principale, che contiene la sorgente luminosa del LED, è il fulcro di tutta la collezione di prodotti; combinato con diversi tipi di accessori crea numerose possibilità di utilizzo, offrendo una varietà di opzioni per progetti residenziali o commerciali. Solitario può anche passare facilmente dal moderno ad un ambiente più decorativo, a seconda della finitura e della composizione scelta.

U P P

Solitario system, satin golden nickel finish with acid-etched glass sphere.  
Sistema Solitario, finitura nickel dorato satinato con sfera vetro acidato.



Solitario system, matt black silk lacquered finish with acid-etched glass spheres.  
Sistema Solitario, finitura laccato nero seta opaco con sfere in vetro acidato.



Solitario Mini wall light, satin golden nickel finish with IP44 protection rating.  
Solitario Mini lampada a parete, nickel dorato satinato con grado di protezione IP44.

Solitario ceiling lamp, satin golden nickel finish with "flood" lens.  
Lampada a plafone Solitario, finitura nickel dorato satinato con lente "flood".



# solitario



**SOLITARIO SUSPENSION COMPOSITION EXAMPLES / ESEMPI COMPOSIZIONE SOLITARIO SOSPENSIONE**

**3X COMPOSITION / COMPOSIZIONE X3**

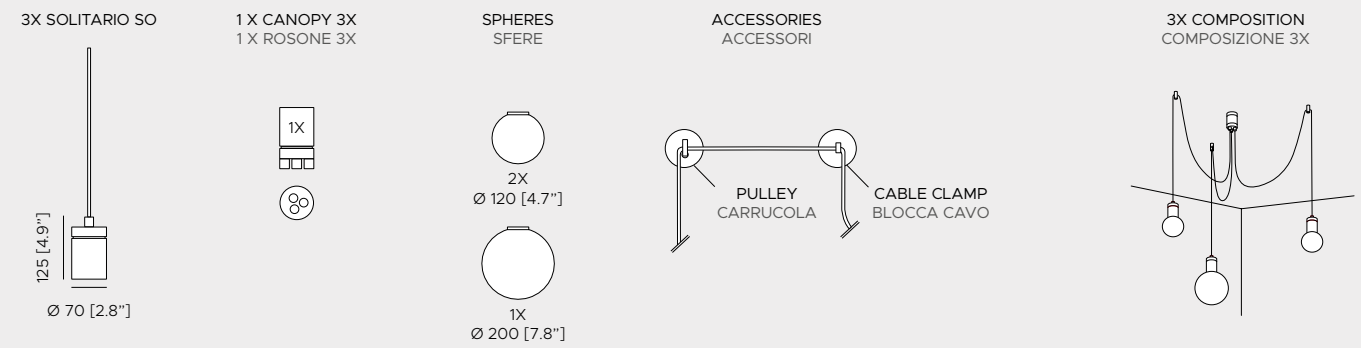

**5X COMPOSITION / COMPOSIZIONE X5**

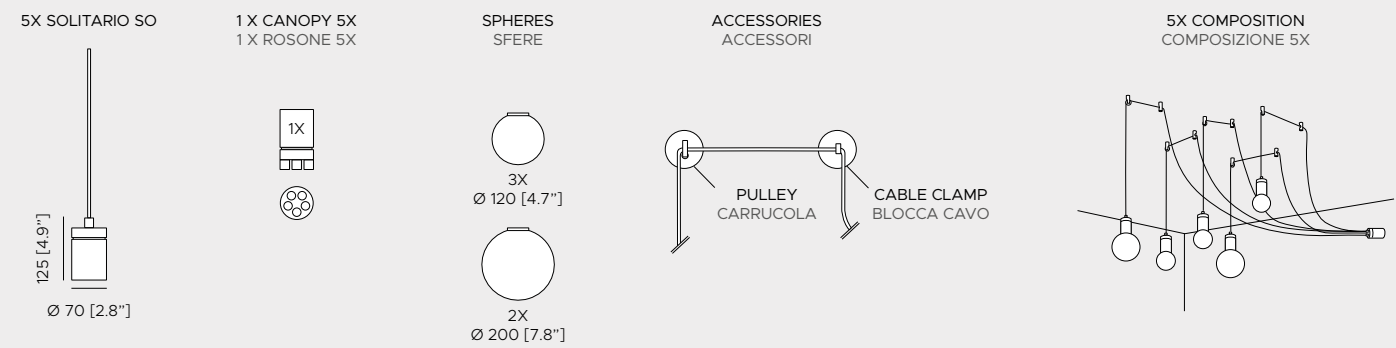

**INFINITE COMPOSITIONS / COMPOSIZIONI INFINITE**

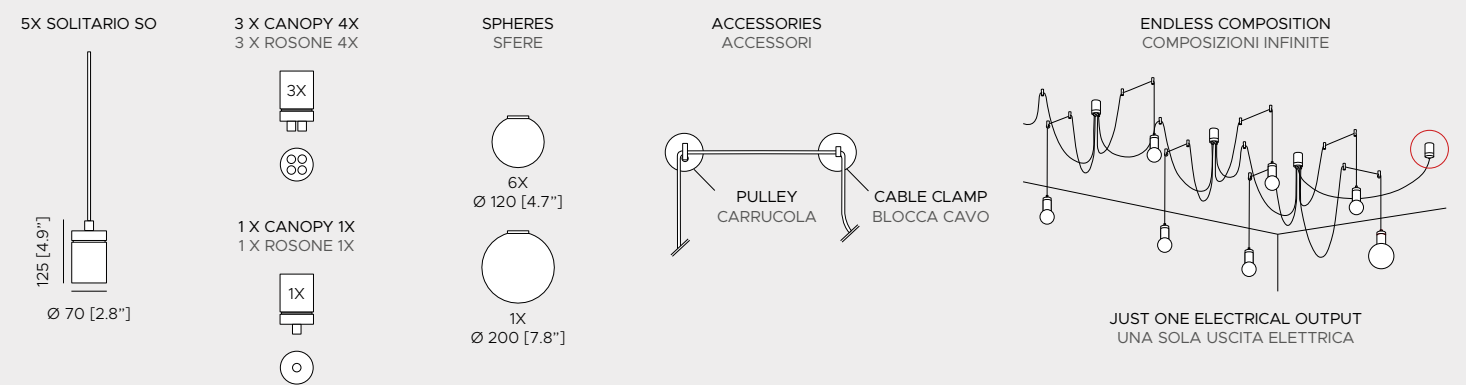

# solitario

IP20 · IP44

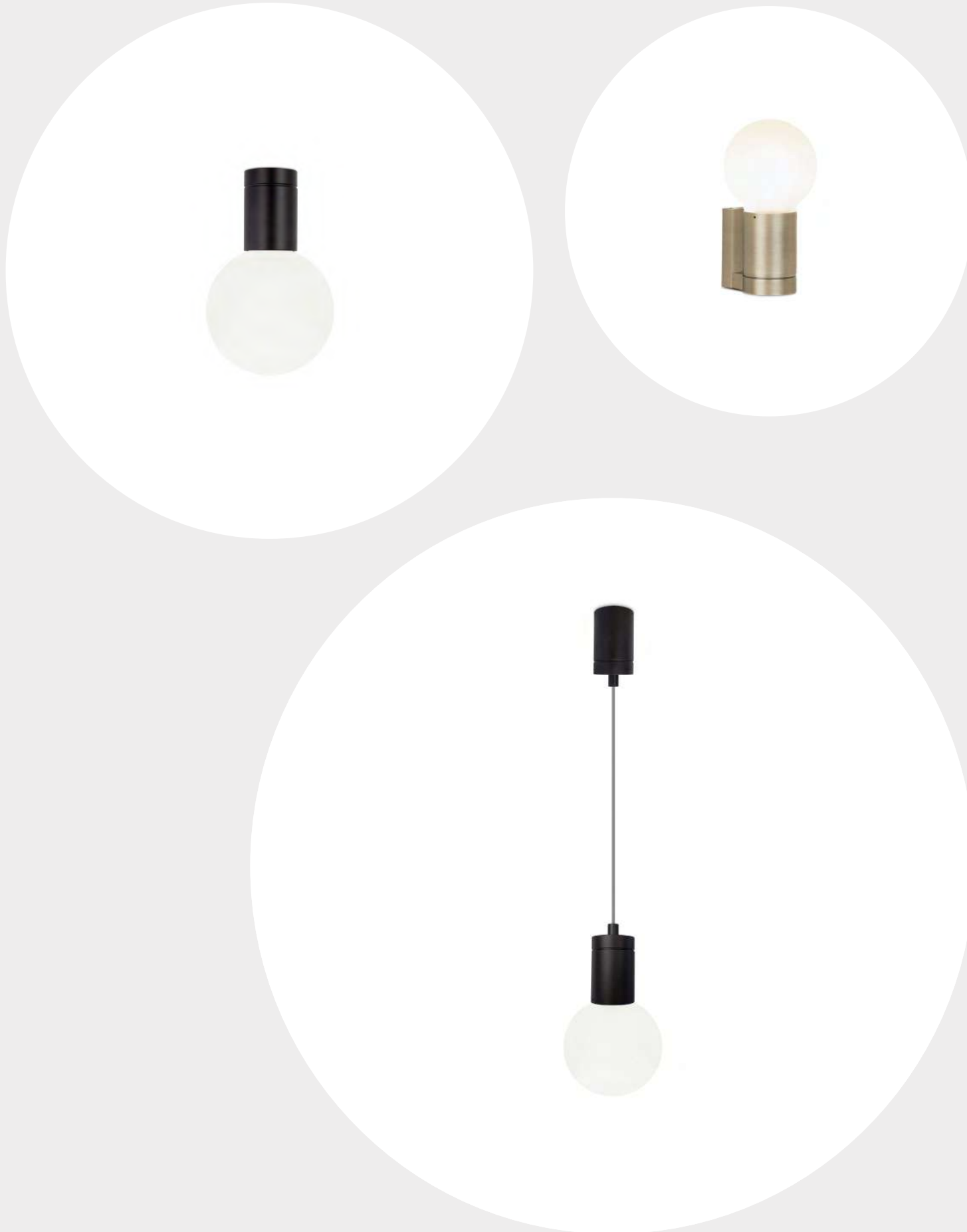

**SUSPENSION / SOSPENSIONE**



**SUSPENSION**

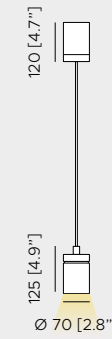

**CEILING / PLAFONE**



**H.10**



**H.25**

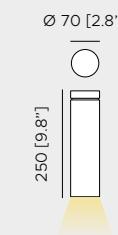

**WALL / PARETE**



**MINI IP44**

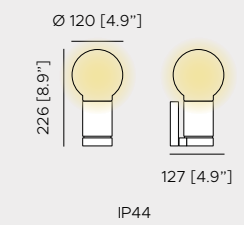

**SUSPENSION AND CEILING ACCESSORIES / ACCESSORI SOSPENSIONE E PLAFONE**



**LIGHT SOURCE / FONTE LUMINOSA**

**220-240V · 110V**  
**SUSPENSION - CEILING / SOSPENSIONE - PLAFONE**  
 1x7.5 W GU10 · 650 Lm  
 3000 K · CRI >90  
 dimming LED light bulb included / lampadina LED dimmerabile inclusa

**MINI IP44**  
 1x7 W G9  
 LED light bulb / lampadina LED  
 IP44

**DIMMING / DIMMERAZIONE**

compatible with remote control system when dimmable LED bulbs are used  
 compatibile con sistemi di controllo remoto con lampadine LED dimmerabili

**FINISHES / FINITURE**  
 frame / struttura

satin golden nickel / nickel dorato satinato matt black silk lacquered / laccato nero seta opaco

diffuser / diffusore

acid-etched glass sphere / sfera vetro acidato flood lens / lente flood

**CABLE / CAVO**  
 4000mm [157.4"] standard

grey colour fabric / tessuto color grigio

extra cable / cavo extra

up to 10000 mm [393.7"] on demand / fino a 10000 mm [393.7"] su richiesta



# — stick

DESIGN STUDIOPEPE

Stick represents the beauty of form. With triangular elements and clean lines, it emits an evocative and functional light, while the ribbed diffuser adds a decorative touch. The range includes wall, pendant, and floor versions. Aesthetically minimalist, Stick blends pure and architectural elements into a lighting fixture of great character.

Stick rappresenta la bellezza delle forme. Con elementi triangolari dalle linee essenziali, emana una luce suggestiva e funzionale, mentre il diffusore cannettato aggiunge un elemento decorativo. La gamma comprende versioni a parete, sospensione e da terra. Esteticamente minimalista, Stick fonde elementi puri e architettonici in un corpo illuminante di grande carattere.

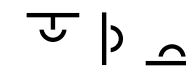

Stick trio, suspension lamp,  
satin golden nickel finish with ribbed plexiglass diffuser.  
Lampada a sospensione Stick trio,  
finitura nickel dorato satinato con diffusore in plexiglass rigato.

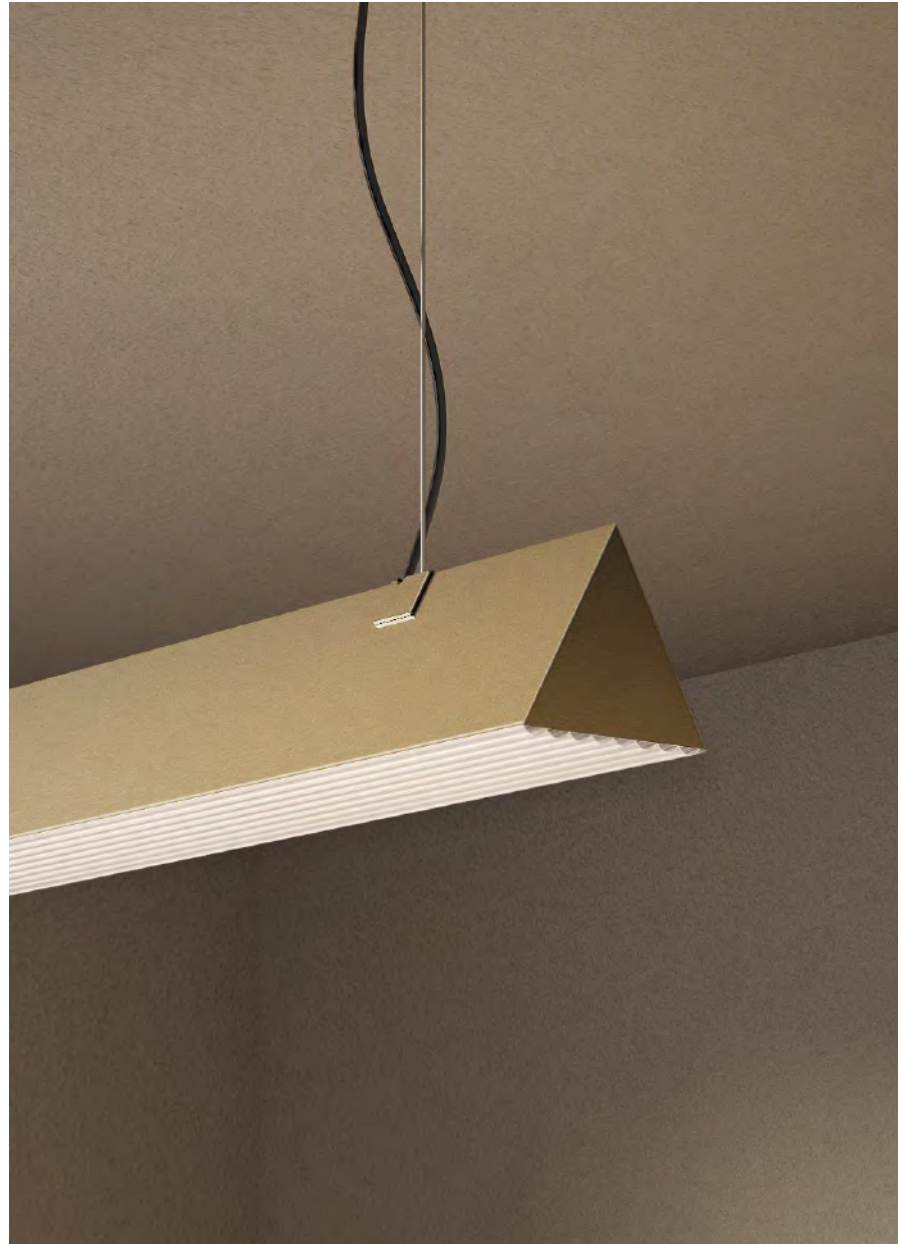

Stick suspension lamp detail,  
satin golden nickel finish and ribbed plexiglass diffuser.  
Dettaglio lampada a sospensione Stick,  
finitura nickel dorato satinato e diffusore plexiglass rigato.

Stick suspension lamps, 900 mm [35.4"].  
Lampade a sospensione Stick 900 mm [35.4"].







Group of 6 Stick trio wall lamps,  
brushed bronze-nickel finish  
and ribbed plexiglass diffuser.

Gruppo di 6 lampade da parete Stick trio,  
finitura bronzo-nichel spazzolato  
e diffusore plexiglass rigato.

Stick, double wall lamp version with front and lateral light emission. Equipped to be oriented either to the right or left, ensuring diffused illumination. Ideal for placement beside a mirror.

The Stick wall versions in small, medium, and double sizes have an IP44 protection rating.

Stick double, lampada a parete con emissione frontale e laterale. Può essere orientata verso destra o sinistra per garantire un'illuminazione diffusa. Ideale ai lati di uno specchio.

Le versioni a parete small, medium e double di Stick hanno grado di protezione IP44.

INSTALLATION EXAMPLE / ESEMPIO DI INSTALLAZIONE

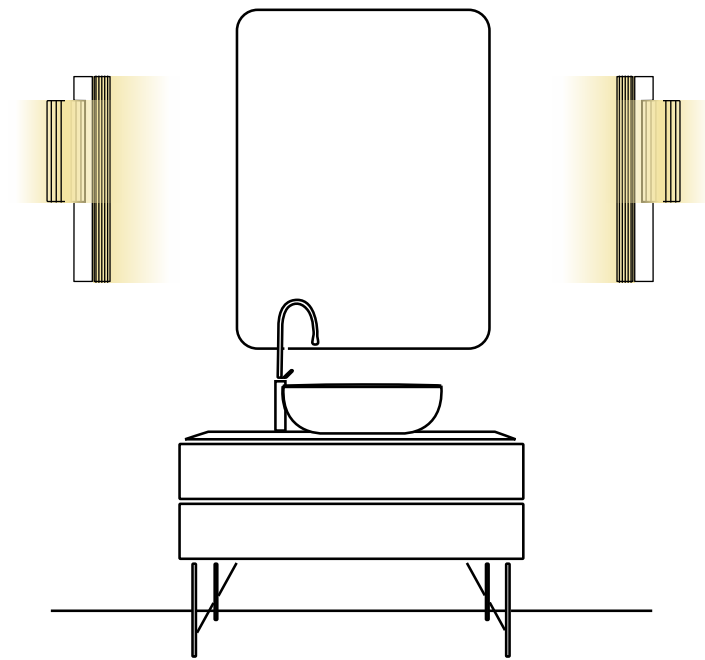

Stick double left  
Stick double sinistra

Stick double right  
Stick double destra

Stick double, wall lamp version right, satin golden nickel finish and ribbed plexiglass diffuser.  
Lampada da parete Stick double destra, finitura nickel dorato satinato e diffusore plexiglass rigato.





Stick floor lamp, rotating base, brushed bronze-nickel finish and ribbed plexiglass diffuser.

Stick floor, base rotativa, finitura bronzo-nickel spazzolato e diffusore plexiglass rigato.



Stick floor lamp, satin golden nickel finish and ribbed plexiglass diffuser.

Lampada da terra Stick, finitura nickel dorato satinato e diffusore plexiglass rigato.

# stick

IP20



**SUSPENSION / SOSPENSIONE**



L.900 / 1500



TRIO

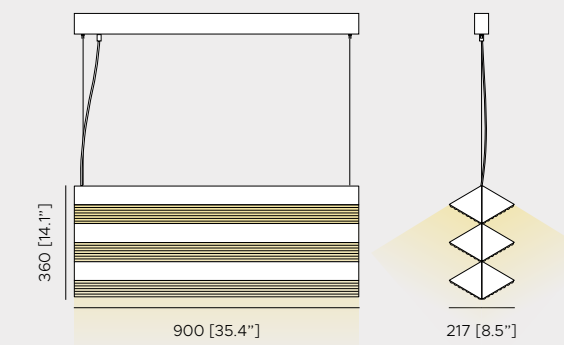
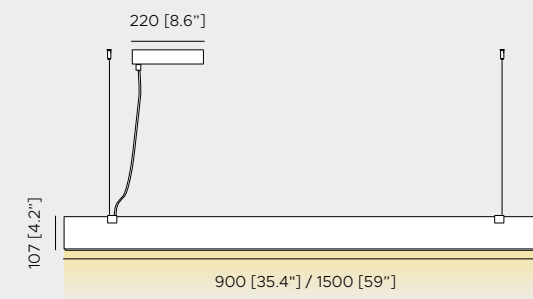

**LIGHT SOURCE / FONTE LUMINOSA**

**220-240V · 110V**

**L.900**  
1x40 W Custom LED · 3750 Lm  
2700 K · CRI >90

**L.1500**  
1x65 W Custom LED · 6250 Lm  
2700 K · CRI >90

**TRIO**  
6x40 W Custom LED · 22500 Lm  
2700 K · CRI >90

**DIMMING / DIMMERAZIONE**

phase cut · Triac / taglio di fase · Triac  
1-10V · DALI on demand / 1-10V · DALI su richiesta

**FINISHES / FINITURE**

frame / struttura

 satin golden nickel  
nickel dorato satinato

 brushed bronze-nickel  
bronzo-nickel spazzolato

diffuser / diffusore

 ribbed plexiglass  
plexiglass rigato

**CABLE / CAVO**  
2000mm [79.7"] standard

 transparent steel  
acciaio trasparente

 steel cables for the balance  
cavi di bilanciamento in acciaio

extra cable / cavo extra

up to 5000 mm [196.8"] on demand / fino a 5000 mm [196.8"] su richiesta  
up to 10000 mm [393.7"] on demand / fino a 10000 mm [393.7"] su richiesta

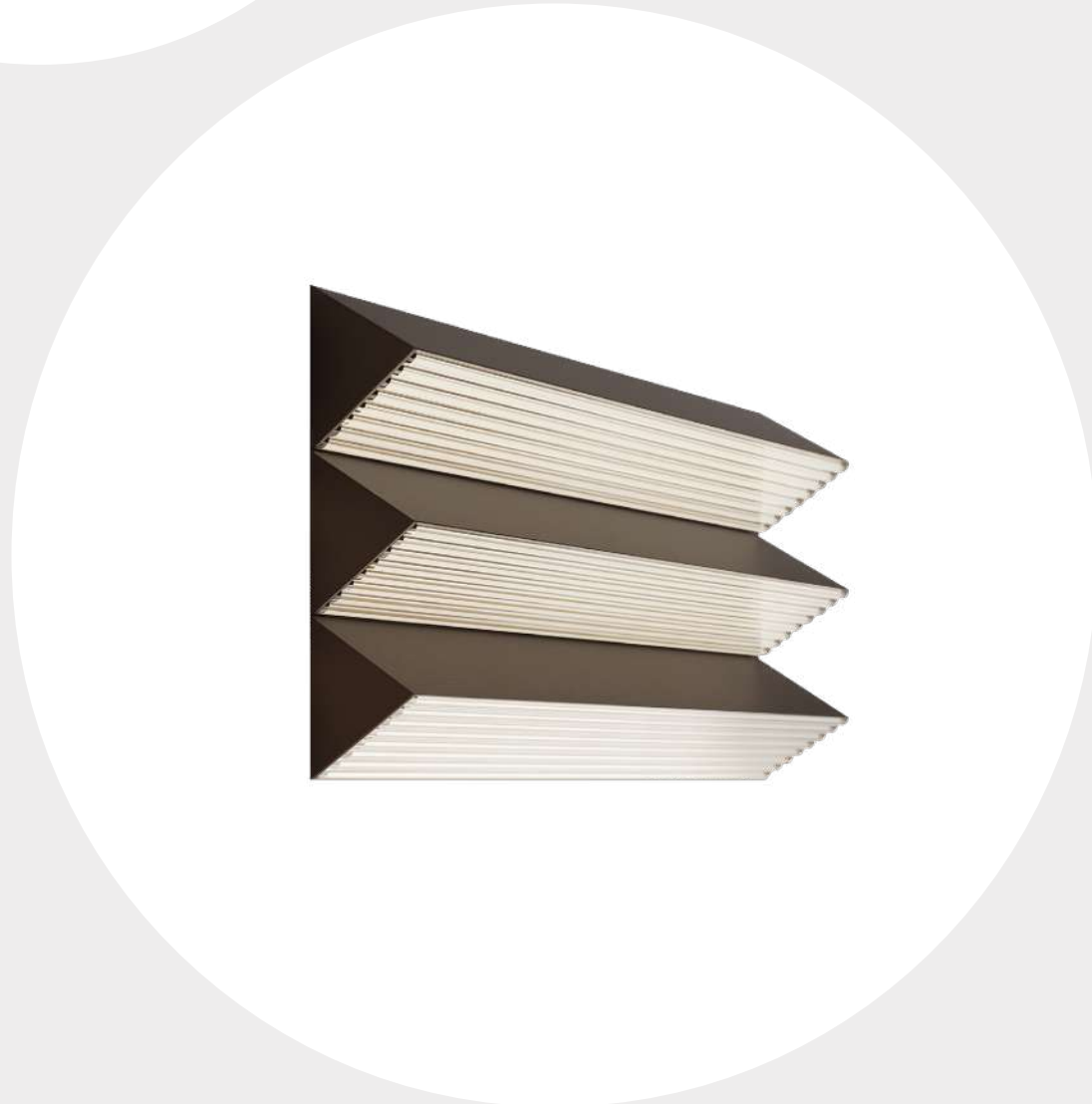
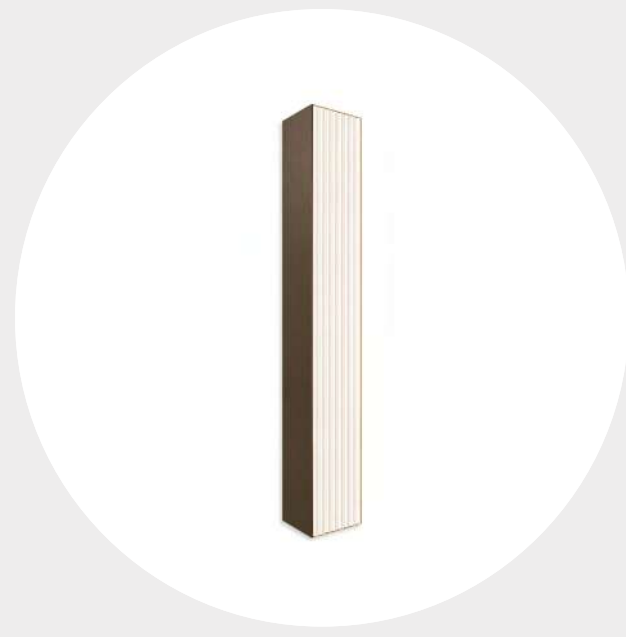

# stick

IP20 · IP44

**WALL / PARETE**



**SMALL**

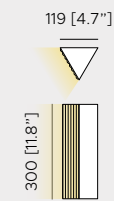

IP44



**MEDIUM**

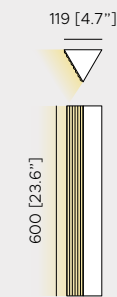

IP44

**DOUBLE**

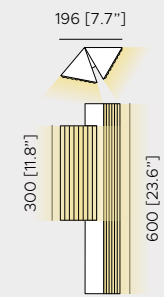

RIGHT VERSION  
VERSIONE DESTRA  
IP44

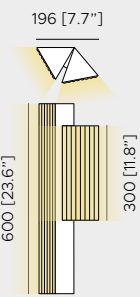

LEFT VERSION  
VERSIONE SINISTRA  
IP44



**TRIO**

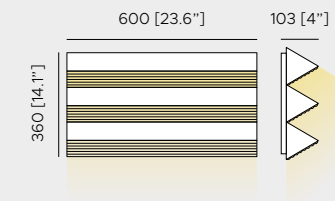

**LIGHT SOURCE / FONTE LUMINOSA**

**220-240V · 110V**

**SMALL**  
1x13.5 W Custom LED · 1250 Lm  
2700 K · CRI >90  
IP44

**MEDIUM**  
1x27 W Custom LED · 2500 Lm  
2700 K · CRI >90  
IP44

**DOUBLE / DOPPIA**  
1x13.5 W + 1x27 W Custom LED · 3750 Lm  
2700 K · CRI >90  
IP44

**TRIO**  
3x27 W Custom LED · 7500 Lm  
2700 K · CRI >90

**DIMMING / DIMMERAZIONE**

phase cut · Triac / taglio di fase · Triac  
1-10V · DALI on demand / 1-10V · DALI su richiesta

**FINISHES / FINITURE**  
frame / struttura

 satin golden nickel  
nickel dorato satinato

 brushed bronze-nickel  
bronzo-nickel spazzolato

diffuser / diffusore

 ribbed plexiglass  
plexiglass rigato

# stick

IP20



**FLOOR / TERRA**

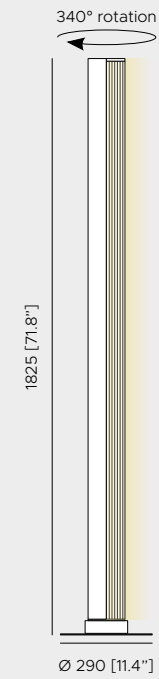

**LIGHT SOURCE / FONTE LUMINOSA**

**220-240V · 110V**  
5x13.5 W Custom LED · 7.500 Lm  
2.700 K · CRI >90

**SWITCH / INTERRUTTORE**

foot switch / interruttore a piede

**DIMMING / DIMMERAZIONE**

dimmable / dimmerabile

**FINISHES / FINITURE**  
frame / struttura

 satin golden nickel  
nickel dorato satinato

 brushed bronze-nickel  
bronzo-nickel spazzolato

diffuser / diffusore

 ribbed plexiglass  
plexiglass rigato

**CABLE / CAVO**  
2000mm [78.7\"/>

 black colour fabric  
tessuto color nero



# — tenebra

DESIGN JAN VAN LIERDE

With its minimalist design, Tenebra offers precise lighting, ideal for modular compositions. Available in golden nickel, bronze nickel and matt black lacquered finishes for the indoor version.

Dal design minimale, Tenebra offre una luce puntuale ideale per composizioni modulari. Disponibile nelle finiture nickel dorato, bronzo-nichel e laccato nero seta opaco nella versione indoor.

h

Tenebra suspension lamp, bronze-nickel finish.  
Lampada a sospensione Tenebra, finitura bronzo-nichel.



Tenebra suspension lamp, golden nickel finish.  
Lampada a sospensione Tenebra, finitura nickel dorato.



Tenebra suspension lamps, golden nickel finish.  
Lampade a sospensione Tenebra, finitura nickel dorato.



# tenebra

IP20 · IP65

**SUSPENSION / SOSPENSIONE**

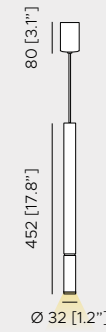

**LIGHT SOURCE / FONTE LUMINOSA**

**220-240V · 110V**  
1x3 W LED module · 500 Lm  
2.700 K · CRI >90

**FINISHES / FINITURE**

frame / struttura

- matt black lacquered  
laccato nero opaco
- bronze-nickel  
bronzio-nichel
- golden nickel  
nickel dorato

**CABLE / CAVO**  
2000mm [79.7\"] standard

black colour fabric  
tessuto color nero

extra cable / cavo extra

up to 5000 mm [196.8\"] on demand / fino a 5000 mm [196.8\"] su richiesta  
up to 10000 mm [393.7\"] on demand / fino a 10000 mm [393.7\"] su richiesta





**out  
do  
or**



# — calypso

DESIGN SERVOMUTO

Inspired by Art Déco, Calypso represents Contardi's highest textile expression. Available in pendant and floor versions, this lamp combines a waltz of colours and materials: waterproof and fireproof fabrics, created for resisting outdoor elements in the outdoor version, marine rope, metal, and glass. The geometric black-and-white patterns blend with bright colours inspired by South American and tropical cultures, creating a striking and original visual impact. IP65 and Marine Grade protection.

Calypso, ispirata all'Art Déco, rappresenta la massima espressione tessile di Contardi. Questa lampada, disponibile a sospensione e a terra, combina un walzer di colori e materiali: tessuti impermeabili e ignifughi, adatti a resistere agli agenti esterni nella versione outdoor, corda marina, metallo e vetro. I motivi geometrici in bianco e nero si mescolano a colori accesi ispirati alla cultura sudamericana e tropicale, creando un impatto visivo sorprendente e originale. Protezione IP65 e Marine Grade.

Suspension lamps Calypso:  
Antigua XL, Guadaloupe black and Martinique building.  
Lampade a sospensione Calypso:  
Antigua XL, Guadaloupe black e Martinique building.

h  
h



Martinique yellow shade detail, with transparent glass diffuser.  
Dettaglio paralume Martinique yellow, diffusore in vetro trasparente.



Calypso suspension.  
Sospensioni Calypso.



Table detail of Calypso floor lamp.  
Dettaglio tavolino lampada da terra Calypso.

Floor lamp with table, Guadeloupe Sale & Pepe shade.  
Lampada da terra con tavolino, paralume Guadeloupe Sale & Pepe.



# calypso

IP65



SUSPENSION / SOSPENSIONE



ANTIGUA

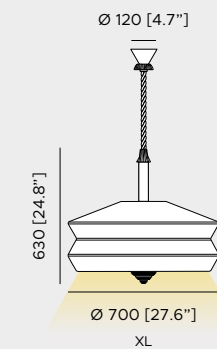
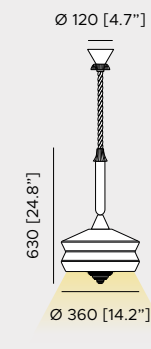

GUADALOUPE

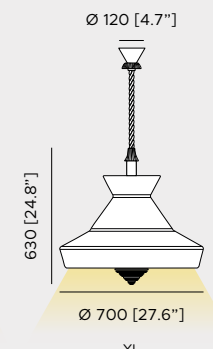
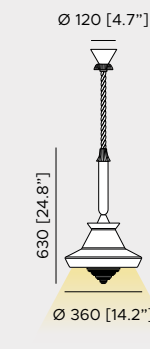

MARTINIQUE

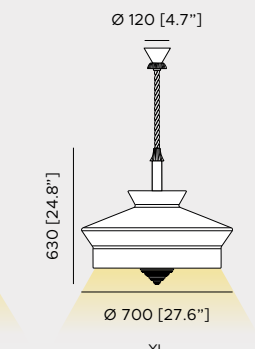
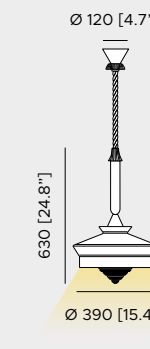

LIGHT SOURCE / FONTE LUMINOSA

**220-240V**  
1x9 W E27 T8  
LED light bulb / Lampadina LED  
IP65

**110V**  
1x9 W E26 T8  
LED light bulb / Lampadina LED  
IP65

DIMMING / DIMMERAZIONE

compatible with remote control system when dimmable LED bulbs are used /  
compatibile con sistemi di controllo remoto con lampadine LED dimmerabili

FINISHES / FINITURE  
frame / struttura

 matt gold lacquered  
laccato oro opaco

shade / paralume  
CALYPSO - CALYPSO XL



CALYPSO

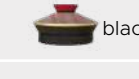
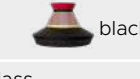
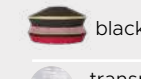
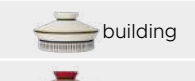
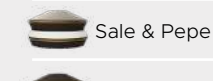

diffuser / diffusor

 transparent glass  
vetro trasparente

ROPE · CABLE / CORDA · CAVO  
2000mm [79.7"] standard

 green waterproof braided rope  
corda marina intrecciata in tinta verde

extra rope · cable / corda extra · cavo

up to 5000 mm [196.8"] on demand / fino a 5000 mm [196.8"] su richiesta  
up to 10000 mm [393.7"] on demand / fino a 10000 mm [393.7"] su richiesta

# calypso

IP65



FLOOR / TERRA



ANTIGUA

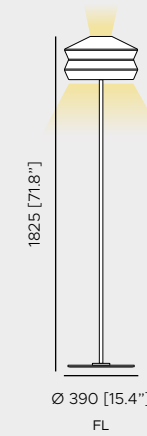
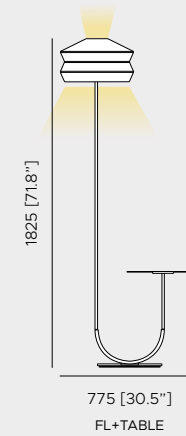

GUADALOUPE

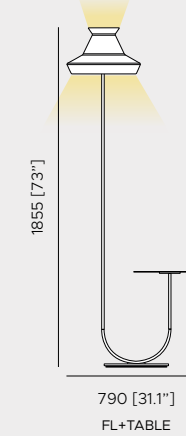

MARTINIQUE

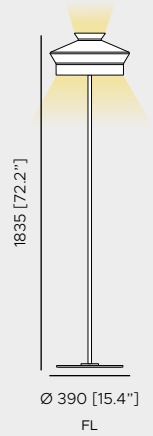
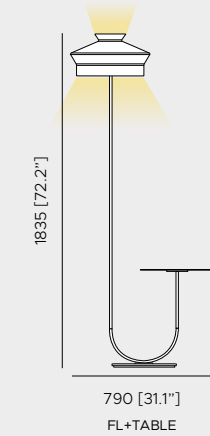

LIGHT SOURCE / FONTE LUMINOSA

**220-240V**  
1x9 W E27 T8  
LED light bulb / Lampadina LED  
IP65

**110V**  
1x9 W E26 T8  
LED light bulb / Lampadina LED  
IP65

supplied by IP68 outdoor connector / fornito con connettore da esterno IP68

DIMMING / DIMMERAZIONE

compatible with remote control system when dimmable LED bulbs are used / compatibile con sistemi di controllo remoto con lampadine LED dimmerabili

FINISHES / FINITURE  
frame / struttura

 matt black  
laccato nero

 reseda green lacquered  
laccato verde reseda

shade / paralume

**ANTIGUA**  
 mint

**GUADALOUPE**  
 Sage & Pepe

**MARTINIQUE**  
 yellow

 building

CABLE / CAVO  
2000 mm [78.7] standard

 black  
nero





# — clara

DESIGN CHIARA CABERLON  
IN COLLABORATION WITH MARCO FORBICIONI

Clara arises from the desire to make lighting nomadic. With its rechargeable battery and top ring, this luminous element can be transported and hung in any corner. Blending outdoor and indoor, retro and modern, its hybrid nature offers versatile and transversal lighting. The lacquered metal and Vienna straw-like texture evoke a refined Italian style. With its warm and evocative light, Clara is a lantern of great emotional power, enhanced by the innovative technology. IP65 and Marine Grade protection.

Clara nasce dal desiderio di rendere l'illuminazione nomade. Questo elemento luminoso, con la sua batteria ricaricabile e l'anello nella parte superiore, può essere trasportato e appeso in ogni angolo. La sua natura ibrida, tra esterno e interno, retrò e moderno, offre un'illuminazione versatile e trasversale. Il metallo laccato e la texture effetto paglia di Vienna evocano uno stile italiano raffinato. Clara, con la sua luce calda e suggestiva, è una lanterna dal grande potere evocativo che è completato dalla innovativa tecnologia utilizzata. Protezione IP65 e Marine Grade.



Rechargeable battery-powered lamp, small size, bronze lacquered version.  
Lampada a batteria ricaricabile, versione small, finitura laccato bronzo.



Rechargeable battery-powered lamps, large, small and medium sizes.  
Lampade a batteria ricaricabili, versioni large, small e medium.



Small version, bronze lacquered finish frame,  
Vienna straw effect resin diffuser.  
Versione small, struttura finitura laccato bronzo,  
diffusore in resina effetto paglia di Vienna.

Medium and large versions, bronze lacquered finish frame,  
Vienna straw effect resin diffuser.  
Versione medium e large, struttura finitura laccato bronzo,  
diffusore in resina effetto paglia di Vienna.





Portable battery operated light source, removable by rotating the handle, available only for the medium and large versions.  
 Fonte luminosa a batteria ricaricabile, estraibile con la rotazione della maniglia, disponibile solo per le versioni medium e large.



Radial lighting effect from the light source.  
 Effetto luminoso a raggiera della fonte luminosa.

# clara

IP65



**TABLE / TAVOLO**



**SMALL**

Ø 163 [6.4"]



Ø 54 [2.1"]



336 [13.2"]

**FLOOR / TERRA**



**MEDIUM**

285 [11.2"]



Ø 54 [2.1"]



616 [24.1"]

**LARGE**

361 [14.2"]



Ø 54 [2.1"]



225 [8.8"]

831 [32.7"]

**BATTERY**

Autonomy: 6/8 hours  
Life cycles: 600  
Charging time: 4 hours  
USB cable type C supplied,  
power supply not supplied

**BATTERIA**

Autonomia: 6/8 ore  
Cicli di vita: 600  
Tempo di ricarica: 4 ore  
Cavo USB tipo C fornito,  
alimentatore non fornito

**ON / OFF SWITCHING / ACCENSIONE / SPEGNIMENTO**

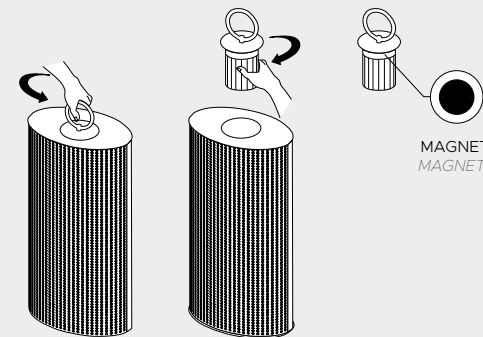

MAGNETI  
MAGNETS

USB Type-C port for  
charging the battery of  
the Clara product.

Ingresso USB  
tipo-C per caricare  
la batteria del  
prodotto Clara.

**LIGHT SOURCE / FONTE LUMINOSA**

**220-240V · 110V**

1x3 W LED module · 400 Lm  
3000 K · CRI >90  
IP65

**FINISHES / FINITURE**

frame / struttura

○ matt white lacquered  
laccato bianco opaco

● bronze lacquered  
laccato bronzo

diffuser / diffusore

● Vienna straw resin effect  
resina effetto paglia di Vienna



# — claretta

DESIGN CHIARA CABERLON

Claretta is the table lamp designed by Chiara Caberlon. Inspired by the portability of the Clara collection, it is crafted to enhance gardens and terraces with style. Thanks to its wireless autonomy and versatile design, Claretta offers elegant and discreet lighting for outdoor spaces, making them ideal for evening gatherings under the stars. Available in four sophisticated finishes, Claretta seamlessly combines functionality and aesthetics, creating enchanting and welcoming atmospheres.

Claretta è la lampada da tavolo firmata Chiara Caberlon. Ispirata alla trasportabilità della collezione Clara, è pensata per valorizzare con stile giardini e terrazze. Grazie alla sua autonomia senza fili e al design versatile, Claretta illumina con eleganza e discrezione spazi all'aperto, rendendoli perfetti per serate conviviali sotto le stelle. Disponibile in quattro raffinate finiture, Claretta unisce funzionalità e bellezza, creando atmosfere suggestive e accoglienti.



Battery-powered table lamp, dark red frame and transparent ribbed plexiglass diffuser.

Lampada da tavolo a batteria, struttura rosso scuro e diffusore in plexiglass rigato trasparente.



Battery-powered table lamp,  
white lacquered frame and transparent  
ribbed plexiglass diffuser.

Lampada a batteria da tavolo, struttura  
laccato bianco e diffusore in plexiglass  
rigato trasparente.



Radial lighting effect from the light source.  
Effetto luminoso a raggera della fonte luminosa.

Battery-powered table lamp,  
bronze lacquered frame and transparent ribbed plexiglass diffuser.  
Lampada da tavolo a batteria,  
struttura laccato bronzo e diffusore in plexiglass rigato trasparente.





# claretta

IP65

**TABLE / TAVOLO**

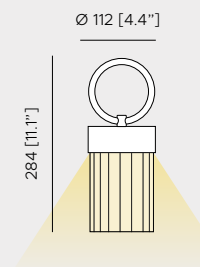

**BATTERY**  
 Autonomy: 6/8 hours  
 Life cycles: 600  
 Charging time: 4 hours  
 USB cable type C supplied,  
 power supply not supplied

**BATTERIA**  
 Autonomia: 6/8 ore  
 Cicli di vita: 600  
 Tempo di ricarica: 4 ore  
 Cavo USB tipo C fornito,  
 alimentatore non fornito

**ON / OFF SWITCHING / ACCENSIONE / SPEGNIMENTO**

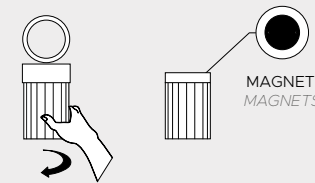





USB Type-C port for charging the battery of the Claretta product.  
 Ingresso USB tipo-C per caricare la batteria del prodotto Claretta.

**LIGHT SOURCE / FONTE LUMINOSA**

**220-240V · 110V**  
 1x3 W LED module · 400 Lm  
 3000 K · CRI >90  
 IP65

**FINISHES / FINITURE**  
 frame / struttura

-  matt white lacquered  
laccato bianco opaco
-  bronze lacquered  
laccato bronzo
-  golden nickel  
nickel dorato
-  dark red  
rosso scuro

diffuser / diffusore

 transparent ribbed plexiglass  
plexiglass rigato trasparente





# — cube

DESIGN MASSIMILIANO RAGGI

Cube adapts itself to every outdoor environment. Offered in both rechargeable battery and wired versions, this elegant lantern combines practicality and sophistication. The battery version introduces an innovative ignition system, while the charging process is facilitated by the removable battery body. Cube stands out with its gold lacquered interior and dark bronze-effect exterior, but it is also available in total white for a timeless aesthetic. IP65 and Marine Grade protection.

Cube si trasforma per l'ambiente esterno. Proposta sia in versione a batteria ricaricabile che cablata, questa elegante lanterna combina praticità e raffinatezza. La variante a batteria introduce un innovativo sistema di accensione, mentre la ricarica è agevolata dalla rimozione del corpo batteria. Cube si distingue con un interno laccato oro e un esterno effetto bronzo scuro, disponibile anche in total white per un'estetica senza tempo. Protezione IP65 e Marine Grade.

Rechargeable battery small version,  
lacquered white frame and transparent ribbed plexiglass diffuser.  
Versione a batteria ricaricabile small,  
struttura laccato bianco, diffusore in plexiglass rigato trasparente.





Gold lacquered handle detail.  
Dettaglio maniglia laccata oro.

Wired version, bronze exterior finish, gold lacquered interior.  
Versione cablata, finitura esterno bronzo, interno laccato oro.





Battery version, matt white lacquered finish.  
Versione a batteria, finitura laccato bianco opaco.

# cube

IP65



**FLOOR / TERRA**



**BATTERY / BATTERIA**

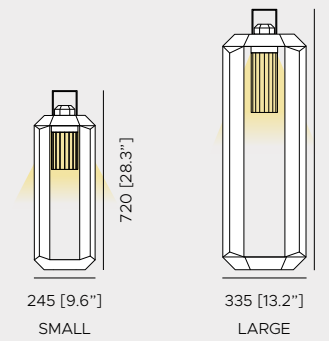

**BATTERY**  
 Autonomy: 6/8 hours  
 Life cycles: 600  
 Charging time: 4 hours  
 USB cable type C supplied,  
 power supply not supplied

**BATTERIA**  
 Autonomia: 6/8 ore  
 Cicli di vita: 600  
 Tempo di ricarica: 4 ore  
 Cavo USB tipo C fornito,  
 alimentatore non fornito

**WIRED / CABLATA**

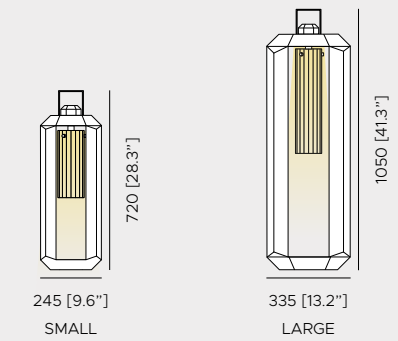

**ON / OFF SWITCHING / ACCENSIONE / SPEGNIMENTO**

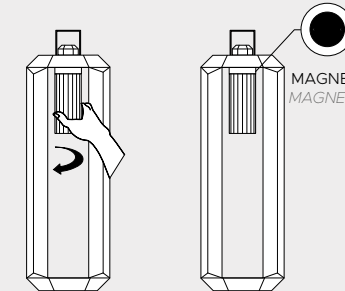

USB Type-C port  
 for charging the  
 battery of the Cube  
 product.  
 Ingresso USB  
 tipo-C per caricare  
 la batteria del  
 prodotto Cube.

**LIGHT SOURCE / FONTE LUMINOSA**

**220-240V**  
**BATTERY / BATTERIA**  
 1x3 W LED module · 400 Lm  
 2700 K · CRI >90  
 IP65

**110V**

**WIRED / CABLATA**  
 1x10 W E27  
 LED light bulb / lampadina LED  
 IP65

**WIRED / CABLATA**  
 1x10 W E26  
 LED light bulb / lampadina LED  
 IP65

**WIRED / CABLATA**  
 supplied with IP68 outdoor connector / fornito con connettore da esterno IP68

**DIMMING / DIMMERAZIONE**

**WIRED / CABLATA**  
 compatible with remote control system when dimmable LED bulbs are used  
 compatibile con sistemi di controllo remoto con lampadine LED dimmerabili

**FINISHES / FINITURE**  
 frame / struttura

● outside: dark bronze - interno: laccato oro  
 esterno: bronzo scuro - inside: gold lacquered ● matt white lacquered (inside/outside)  
 laccato bianco opaco (interno/esterno)

diffuser / diffusore

▨ transparent ribbed plexiglass  
 plexiglass rigato trasparente

**CABLE / CAVO**  
 2000mm [78.7"] standard  
 WIRED / CABLATA

● black  
 nero



# — fly

DESIGN MASSIMILIANO RAGGI

Fly becomes a lighting icon for outdoor spaces as well. Available exclusively as a floor version, in two heights, it retains the elegance and functionality of its indoor counterparts. With dual light emission and IP65 and Marine Grade protection, it withstands the elements and it is ideal for illuminating pathways, walkways and gardens with contemporary style. It can be mounted on different surfaces thanks to an adaptable anchoring system.

Fly diventa un'icona luminosa anche per gli spazi esterni. Disponibile esclusivamente da terra, in due altezze, mantiene l'eleganza e la funzionalità delle versioni indoor. Con doppia emissione luminosa e protezione IP65 e Marine Grade, resiste agli agenti atmosferici ed è ideale per illuminare percorsi, vialetti e giardini con uno stile contemporaneo. Può essere montata su superfici differenti grazie ad un sistema di ancoraggio adattabile.



Floor lamp, double emission, bronze lacquered.  
Lampada da terra, doppia emissione, laccato bronzo.



Double-sides profile, ideal as an outdoor step marker.  
Profilo bifacciale, ideale come segnapasso per esterno.

# fly

IP65

**TERRA / FLOOR**



**H.600**

**H.900**

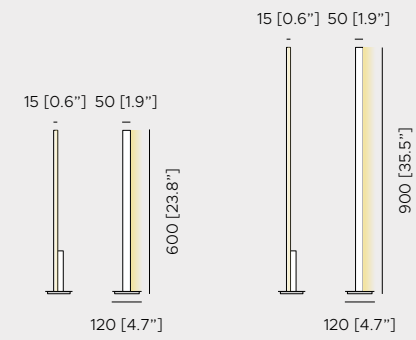

**ACCESSORY FOR GROUND ANCHORING / ACCESSORIO PER ANCORAGGIO A TERRENO**

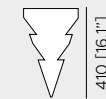

**LIGHT SOURCE / FONTE LUMINOSA**

**220-240V · 110V**

**H.600**  
1x8 W Strip LED  
2700 K · CRI >90  
IP65

**H.900**  
1x12.5 W Strip LED  
2700 K · CRI >90  
IP65

supplied with IP68 outdoor connector / fornito con connettore da esterno IP68

**FINISHES / FINITURE**

frame / struttura

 bronze lacquered  
laccato bronzo

 black lacquered  
laccato nero

**CABLE / CAVO**

2000mm [78.7\"/>

 black  
nero







# — lagoon

DESIGN SERVOMUTO

Lagoon exudes an elegant and refined style, bringing home decor outdoors with a contemporary touch. Inspired by the Typha, a typical plant of marshy areas that characterizes riverbanks and lakes. Available in three heights, with a matt black lacquered structure and copper details, it creates a suggestive "luminous forest" effect. The linear lampshades, covered with Pierre Frey fabrics, add sophistication and personality. IP65 and Marine Grade protection.

Lagoon esprime uno stile elegante e raffinato, portando l'arredo domestico all'aperto con un tocco contemporaneo. Ispirata alla Typha, pianta tipica delle zone paludose che caratterizza gli argini di fiumi e laghi. Disponibile in tre altezze, con struttura in laccato nero opaco e dettagli in rame, crea un suggestivo effetto "foresta luminosa". I paralumi lineari, rivestiti con tessuti Pierre Frey aggiungono raffinatezza e personalità. Protezione IP65 e Marine Grade.



Medium and large floor lamp versions.  
Lampada da terra versioni medium e large.



Lagoon medium Bayamo Mimosa.

Lagoon shade detail with the cover that allows greater downward illumination for ambient lighting.

Dettaglio del paralume Lagoon con la copertura che permette un'illuminazione maggiore verso il basso per una luce d'ambiente.

Composition with floor lamps in three sizes:  
small, medium, and large.  
Composizione con le lampade da terra nelle tre dimensioni:  
small, medium e large.



# lagoon

IP65



FLOOR / TERRA



SMALL

Ø 150 [5.9"]

924 [36.4"]

277 [10.9"]

MEDIUM

Ø 350 [13.7"]

1117 [43.9"]

277 [10.9"]

LARGE

Ø 250 [9.8"]

1624 [63.9"]

277 [10.9"]

LIGHT SOURCE / FONTE LUMINOSA

**220-240V**  
1x9 W E27 T8  
Tubular LED bulb / lampadina tubular LED  
IP65

**110V**  
1x9 W E26 T8  
Tubular LED bulb / lampadina tubular LED  
IP65

supplied with IP68 outdoor connector / fornito con connettore da esterno IP68

DIMMING / DIMMERAZIONE

compatible with remote control system when dimmable LED bulbs are used  
compatibile con sistemi di controllo remoto con lampadine LED dimmerabili

FINISHES / FINITURE  
frame / struttura

● matt black lacquered  
laccato nero opaco

● copper lacquered details  
dettagli laccato rame

shade / paralume

● Noumea Goyave  
(Pierre Frey)

● Dominica Caraibes  
(Pierre Frey)

● Bayamo Mimosa  
(Pierre Frey)

CABLE / CAVO  
2000mm [78.7"] standard

● black  
nero



# — muse

DESIGN TRISTAN AUER

In the heart of Muse lies the essence of functional elegance. Available in both battery and wired versions, in three different sizes, this lantern gracefully illuminates outdoor spaces. In the battery model, the LED light source is enclosed in an opal white glass shaped like a light bulb.

Nel cuore di Muse risiede l'essenza dell'eleganza funzionale. Disponibile in versione a batteria o cablata, in tre diverse dimensioni, questa lanterna illumina gli spazi esterni con grazia. Nel modello a batteria la sorgente luminosa a LED è racchiusa in un vetro opale bianco a forma di lampadina.



Rechargeable battery medium version.  
Versione medium a batteria ricaricabile.



Light source detail, battery-powered version.  
Dettaglio fonte luminosa, versione a batteria.

Muse Lantern battery small and large,  
bronze finish structures and amber-colored acrylic diffusers.  
Muse Lantern small e large a batteria,  
struttura finitura bronzo e diffusori acrilici color ambra.





Muse Lantern, wired suspension medium version.  
Muse Lantern, versione cablata a sospensione medium.

Muse Lantern, wired medium version.  
Muse Lantern, versione cablata medium.

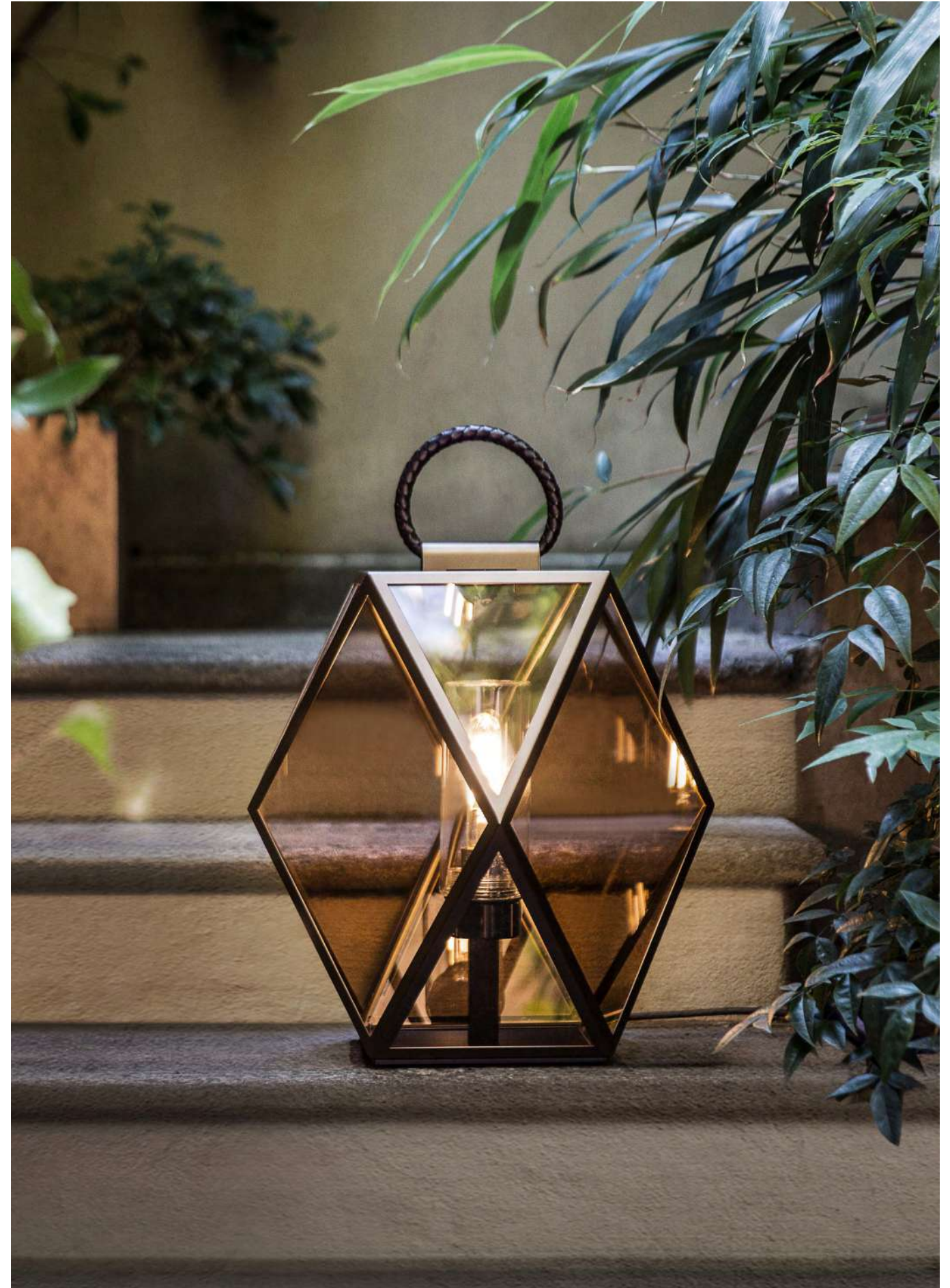



Muse outdoor battery floor lamp, medium and large versions, and Muse outdoor wired suspension, matt black lacquered frame, black leather handle and satin acrylic diffuser.  
Muse outdoor battery da terra, versioni medium e large e muse outdoor sospensione cablata, struttura laccato nero, maniglia in pelle nera e diffusore acrilico satinato.



Muse suspension lamps, matt white lacquered frame with satin acrylic diffuser.  
Lampade a sospensione Muse, struttura laccato bianco opaco, diffusori acrilico satinato.



# muse

IP65



**FLOOR / TERRA**



**BATTERY**

**WIRED**

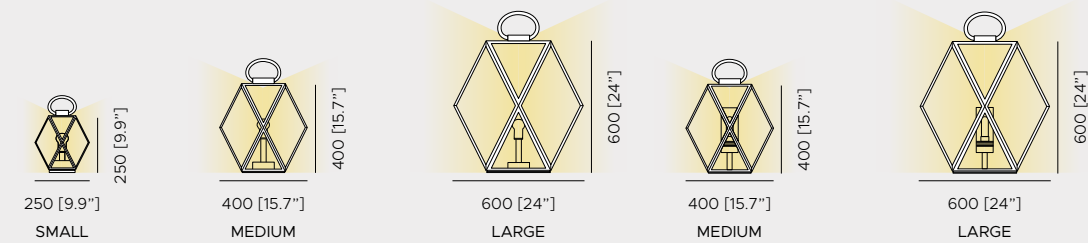

**BATTERY**  
 Autonomy: 6/8 hours  
 Life cycles: 600  
 Charging time: 4 hours  
 USB cable type C supplied,  
 power supply not supplied

**BATTERIA**  
 Autonomia: 6/8 ore  
 Cicli di vita: 600  
 Tempo di ricarica: 4 ore  
 Cavo USB tipo C fornito,  
 alimentatore non fornito

**LIGHT SOURCE / FONTE LUMINOSA**

**220-240V**  
**BATTERY / BATTERIA**  
 1x3 W LED module · 430 Lm  
 3000 K · CRI >90  
 IP65

**110V**  
**BATTERY / BATTERIA**  
 1x3 W LED module · 430 Lm  
 3000 K · CRI >90  
 IP65

**WIRED / CABLATA**  
 1x10 W E27  
 LED light bulb / lampadina LED  
 IP65

**WIRED / CABLATA**  
 1x10 W E27  
 LED light bulb / lampadina LED  
 IP65

**WIRED / CABLATA**  
 supplied with IP68 outdoor connector / fornito con connettore da esterno IP68

**DIMMING / DIMMERAZIONE**

**WIRED / CABLATA**  
 compatible with remote control system when dimmable LED bulbs are used /  
 compatibile con sistemi di controllo remoto in caso di utilizzo di lampadine LED dimmerabili

**FINISHES / FINITURE**  
 frame / struttura

**LANTERN**

**BLACK**

**WHITE**

● bronze lacquered  
 laccato bronzo

● matt black lacquered  
 laccato nero opaco

● matt white lacquered  
 laccato bianco opaco

diffuser / diffusore

● amber acrylic  
 acrilico color ambra

● satin acrylic  
 acrilico satinato

● satin acrylic  
 acrilico satinato

handle / maniglia

● brown braided leather  
 cuoio intrecciato marrone

● black braided leather  
 cuoio intrecciato nero

● white braided leather  
 cuoio intrecciato bianco

**CABLE / CAVO**  
 2000mm [78.7"] standard  
**WIRED / CABLATA**

● black  
 nero

# muse

IP65



**SUSPENSION / SOSPENSIONE**



**MEDIUM**

**LARGE**

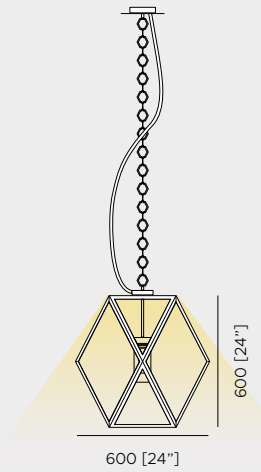
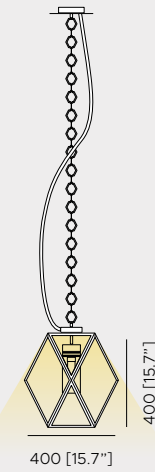

**LIGHT SOURCE / FONTE LUMINOSA**

**220-240V**  
1x10 W E27  
LED light bulb / lampadina LED  
IP65

**110V**  
1x10 W E26  
LED light bulb / lampadina LED  
IP65

**DIMMING / DIMMERAZIONE**

compatible with remote control system when dimmable LED bulbs are used /  
compatibile con sistemi di controllo remoto in caso di utilizzo di lampadine LED dimmerabili

**FINISHES / FINITURE**  
frame / struttura

**LANTERN**

**BLACK**

**WHITE**

● bronze lacquered  
laccato bronzo

● matt black lacquered  
laccato nero opaco

● matt white lacquered  
laccato bianco opaco

diffuser / diffusore

● amber acrylic  
acrilico color ambra

● satin acrylic  
acrilico satinato

● satin acrylic  
acrilico satinato

metal chain / catena in metallo

● bronze lacquered  
laccato bronzo

● matt black lacquered  
laccato nero opaco

● matt white lacquered  
laccato bianco opaco

**CABLE / CAVO**  
1500mm [59"] standard

● black  
nero



# — tenebra

DESIGN JAN VAN LIERDE

With its minimalist design, Tenebra offers focused lighting ideal for modular compositions. Perfect for pergolas and other outdoor settings.

IP65 and Marine Grade protection.

Dal design minimale, Tenebra offre una luce puntuale ideale per composizioni modulari. Ideale per pergolati e altri ambienti esterni.

Protezione IP65 e Marine Grade.



Wired version, matt black lacquered finish.  
Versione cablata, finitura laccato nero opaco.



Suspension light ideal for a focused light.  
Lampada a sospensione per una luce puntuale.

# tenebra

IP65

**SUSPENSION / SOSPENSIONE**

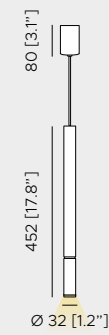

**LIGHT SOURCE / FONTE LUMINOSA**

**220-240V · 110V**  
1x3 W LED module · 500 Lm  
2.700 K · CRI >90

**FINISHES / FINITURE**

frame / struttura

● matt black lacquered  
laccato nero opaco

**CABLE / CAVO**  
2000mm [79.7"] standard

● black  
nero





# — calybabu

DESIGN MASSIMILIANO RAGGI

The exclusive fabrics of Calypso take center stage in Calybabu. This outdoor pouf collection offers three elegant geometric combinations and a multitude of colours. The waterproof fabrics, water-repellent polyurethane padding, and sturdy structure ensure durability and comfort for outdoor use.

Le trame esclusive dei tessuti Calypso diventano protagoniste in Calybabu. La collezione di pouf da esterno dispone di tre eleganti abbinamenti geometrici e di una moltitudine di colori. I tessuti impermeabili, l'imbottitura in poliuretano idrorepellente e la robusta struttura garantiscono durabilità e comfort all'aperto.



Combinations of geometries and colours for an outdoor pouf.  
Combinazioni di geometrie e colori per un pouf da esterno.



Water-repellent pouf as a complement to outdoor lighting products.

Pouf idrorepellenti come complemento dei prodotti di illuminazione da esterno.

# calybabu

FURNISHING ACCESSORY / COMPLEMENTO D'ARREDO



H.450

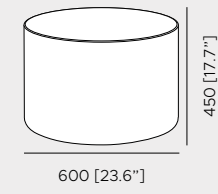

H.600

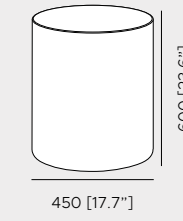

FINISHES / FINITURE  
pattern







**THANKS TO**

**Graphic Project**

Blackspace, Claudia Parisi

**Mise en page**

Claudia Parisi, Martina Castiglieri

**Photography**

Marco Reggi

Francesco Romeo

Lakeroom

**Render**

Truetopia

Operavisual

Arché Agency

Officine Mimesi

Dainelli Studio

Fabu.la

**Print**

Grafiche Antiga, Crocetta del Montello (TV)

© Contardi Lighting Srl  
10.2024

All rights reserved. No part of this publication may be reproduced or transmitted in any form or by any means, electronic or mechanical, without prior permission of the owner. All copyrights and intellectual property rights, including trademarks, patents and copyrights, remain the property of Contardi Lighting Srl and are explicitly reserved.

Tutti i diritti sono riservati. Nessuna parte di questa pubblicazione può essere riprodotta o trasmessa in alcuna forma o con alcun mezzo, elettronico o meccanico, senza il permesso preventivo del proprietario. Tutti i diritti d'autore e di proprietà intellettuale, inclusi marchi, brevetti e copyright, restano di proprietà di Contardi Lighting Srl e sono espressamente riservati.

**CONTARDI LIGHTING SRL**  
Headquarters

Via A. Manzoni, 134/140  
20811 Cesano Maderno – MB  
Italy

Tel. +39 0362 301381  
sales@contardi-italia.it

**CONTARDI MILANO**  
Showroom

Corso Monforte, 20  
20122 Milano – MI  
Italy

Tel. +39 02 82765952  
milano@contardi-italia.it

**CONTARDI USA, INC.**  
USA Branch

303 5th Avenue, Suite 706  
10016 New York - NY  
United States

Tel. +1 718 715 0717  
info@contardi-usa.com

Follow Contardi Lighting on:



