

 **contardi**

indoor



BLENDING
TECHNOLOGY
& CREATIVE
DESIGN

“Mentre mio padre stava dando forma alla luce, stavo imparando come modellare un’azienda”

Achille Carcano, Titolare



Paola & Achille Carcano

1. La nostra storia, la nostra famiglia *Our history, our family*

Contardi, una giovane azienda con una lunga storia. Il primo prodotto a marchio Contardi è stato lanciato nel 2006. Successivamente, l'azienda ha iniziato una crescita costante anno dopo anno, che si è consolidata negli ultimi anni a livello internazionale. Contardi è ora una solida realtà con sede produttiva ed amministrativa in Brianza, il cuore pulsante della manifattura Made in Italy. Tutto comincia grazie al genio creativo di Michele Carcano, che aveva una grande passione per la prototipazione. La sua esperienza nell'azienda Stilnovo gli consentì di sviluppare una notevole competenza nell'illuminazione. Da quel momento, gli eredi di Michele, Achille e Paola Carcano, hanno preso le redini dell'azienda e sono ora supportati da un team unito e compatto. Come in una famiglia allargata, alcuni dei suoi membri sono parte di Contardi sin dagli albori. Contardi è oggi sinonimo di servizio, qualità e flessibilità. Queste caratteristiche hanno consentito all'azienda di guadagnarsi la fiducia di architetti, interior designer e consulenti di illuminazione, figure professionali sempre alla ricerca di originalità e design decorativo e funzionale, oltre che di esperienza e servizio di alto livello.

We are a young company with a long history. Our first Contardi branded product dates back to 2006, thereafter the company began to constantly grow year after year, and the expansion has consolidated in the last six years. Contardi is now a well-established company headquartered in the Brianza district - the beating heart of the "Made in Italy" manufacturing. Before then, Contardi had a 30-year history of successful collaborations, providing its lighting expertise to some of the most iconic companies on the Italian design scene. It all started from the creative genius of Michele Carcano, who had a real passion for prototyping and worked for Stilnovo - one of the first companies to build a reputation in lighting design. Fast-forward to today, and Michele Carcano's heirs - Achille and Paola Carcano - have taken the reins of the company, supported by a very close-knit team, more similar to an extended family working together, with some of its members having been part of it since its inception. Contardi is now synonymous with service, quality and flexibility, having become a reliable reference point for architects, interior decorators and lighting consultants who are in search of original and well-designed decorative and functional lighting as well as an unparalleled expertise and service.

1a. Contardi USA

Il percorso aziendale di Contardi ha portato l'azienda ad affacciarsi sul mercato statunitense già nel 2015. Questo mercato ha oggi una grande importanza per il brand. Con l'apertura e presenza della filiale americana, Contardi risponde in tempo reale alle esigenze provenienti da questo mercato.

L'apertura della filiale americana ci garantisce un presidio diretto in uno dei punti nevralgici del mondo, con una forte presenza nell'e-commerce e l'ottenimento della certificazione ETL.

Contardi's business path led the company to enter the US market as early as 2015. Today this market is of great importance for the brand. With the opening and presence of the American branch, Contardi responds in real time to the needs of this market.

The American branch, which is ETL certified, guarantees our brand a direct participation in one of the key regions of the world, with a strong presence in e-commerce.

“While dad was giving a shape to light, I was learning how to shape a company”

Achille Carcano, Owner

2. Contardi Contract Division

Lavoriamo fianco a fianco con architetti, interior designer e consulenti di illuminazione. Grazie a questo, Contardi ha sviluppato la capacità sia di tradurre i concetti dei designer, che di soddisfare le richieste del cliente e di rispettare il budget dei progetti. **Hotels, ristoranti, e yacht** diventano il palcoscenico della versatilità dei nostri prodotti, che si uniscono perfettamente all'ambiente circostante, indipendentemente dallo stile e dalle caratteristiche del progetto stesso. La Divisione Contract Contardi offre un servizio mirato in base alle richieste del cliente:

*We work closely with architects, interior decorators and lighting designers, so we are able to catch and translate the designer's concepts, meeting the client's needs and the budget of the project. **Hotels, restaurants and yachts** become stages where the versatility of products blends perfectly with the surroundings, independently from the style and the characteristics of the project itself. Contardi Contract Division offers a dedicated service on customer requests:*

**BESPOKE
MODIFIED STOCK
VALUE ENGINEERED**



The Hoxton, Rome



Shangri La, Hong Kong



Mayfair Townhouse, London



The Address Downtown, Dubai



Lutetia Hotel, Paris



The Carlyle, New York

3. Sartorialità e tecnologia *Tailoring and avant-garde technology*

Per Contardi è stato più volte usato l'appellativo di **“Couturier della Luce”**. Nel corso degli anni, siamo riusciti a guadagnarci questa reputazione per il nostro approccio sartoriale, per la varietà dei materiali usati, per l'eleganza delle finiture e per la loro combinazione con le più innovative tecnologie LED. La nostra collezione è disegnata per assicurare che la qualità dell'illuminazione risponda alle esigenze contemporanee.

Internationally renowned as the “Couturier of Contemporary Lighting”, we have earned this reputation over the years for our skilful sartorial approach, for the variety of materials used, as well as the elegance of the finishes combined with the most innovative LED technology, all designed to ensure that the quality of the lighting responds to contemporary requirements.

4. Flessibilità *Flexibility*

La flessibilità è la nostra forza. Ci contraddistingue. L'ampia varietà di stile rappresenta la capacità di interpretare le diverse personalità dei nostri clienti e di adattarsi a molteplici contesti.

Flexibility is our strength and what distinguishes us from the rest. Style variety does not mean a lack of identity though. On the contrary, it means a capacity to interpret different styles and to adapt to different settings.

5. Sostenibilità *Sustainability*

Il nostro impegno per un business sempre più sostenibile è costante. Siamo ora pronti per la nuova sfida di ridurre ulteriormente il nostro impatto ambientale con una serie di obiettivi che miriamo a raggiungere e che rappresentano il nostro orientamento in termini di sostenibilità.

Our commitment to an increasingly sustainable business has emerged over the course of the last few years and, after obtaining some great achievements, we are now ready for a new challenge to further reduce our environmental impact with a clear set of targets, which constitute our Pole Star in terms of sustainability.

6. Certificazioni *Certification*

La presenza di un Brand sul mercato internazionale non può oggi prescindere dalle certificazioni. Contardi risponde a questa esigenza investendo risorse e competenza. Oggi l'azienda è certificata ETL per il mercato americano e CCC per il mercato cinese. Grazie all'ufficio tecnico interno, Contardi riesce a soddisfare le richieste di certificazioni quali: SABER per l'Arabia Saudita, CoC per il Marocco, EAC per il mercato russo.

Today, a Brand's presence on the international market requires the ability to provide certifications. Contardi responds to this need by investing resources and expertise. Our company is ETL certified for the American market, and CCC for the Chinese market. Thanks to the internal technical office, Contardi is able to satisfy requests for certifications such as SABER for Saudi Arabia, CoC for Morocco, and EAC for the Russian market.



A	12 AIR 18 ARCIPELAGO so, ta 26 ASIA so, ap, ta, pl 34 AUDREY so, ta, fl
B	42 BACH 46 BEAM 52 BELLE 56 BOGOTÀ
C	62 CALYPSO so, fl 80 CLESSIDRA 84 CORNELIA & MESSALINA 92 CUBE
D	96 DISCUS so, ap, pl 106 DORIAN so, fl
E	114 ECLISSE 2.0 118 EMMA ap, ta, pl
F	126 FLEXILED ap, fl 132 FLY so, ap, picture
G	144 G+T so, ap, reading, battery
K	158 KUBRIC
M	162 MANHATTAN 166 MELANOCETUS 172 MIKADO so, ap, ta, fl 184 MUSE LANTERN
O	188 ONGO battery

S	192 SOLITARIO so, ap, pl 202 STARDUST 206 STICK so, ap
T	218 TENEBRA wired, battery 224 TREASURE
U	228 UP ap, ta, fl
V	234 VEGAS

CONTARDI SARTORIA

Contardi Tailoring

A	2i ATHENA
C	6i CIRCUS so, pl 12i COCO MEGA & DELUXE ap, ta 16i COCO & COCONETTE
O	22i OVALE ta, fl
T	26i TONDA ap, ta, fl

Lampada a sospensione
Suspension lamp



Air
12

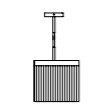

Arcipelago
18



Asia
26



Audrey
34



Belle
52



Bogotá
56



Calypso
62

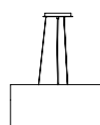

Circus & Circus LED
6i



Cornelia & Messalina
84



Discus
96



Dorian
106

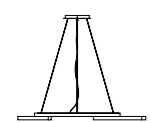

Eclisse 2.0
114



Fly
132



G+T
144



Kubric
158

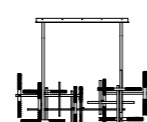

Mikado
172



Solitario
192

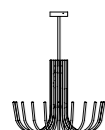

Stardust
202

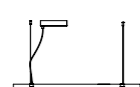

Stick
206



Tenebra
218



Vegas
234

Lampada a parete
Wall lamp



Asia
26



Bach
42



Coco Mega & Deluxe
12i

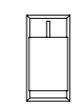

Coco & Coconette
16i

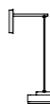

Discus
96



Emma
118

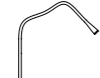

Flexiled
126



Fly
132

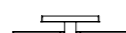

Fly picture
132

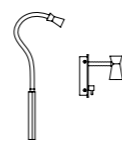

G+T
144



Manhattan
162

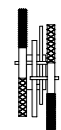

Mikado
172



Solitario
192



Stick
206



Tonda
26i



Up
228

Lampada da lettura
Reading lamp



Flexiled
126

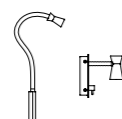

G+T
144



Manhattan
162



Tonda
26i



Up
228

Lampada a soffitto
Ceiling lamp

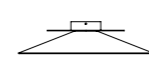

Asia
26

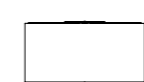

Circus & Circus LED
6i

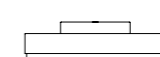

Discus
96



Emma
118

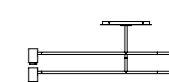

Melanocetus
166



Solitario
192

Lampada da terra
Floor lamp



Audrey
34

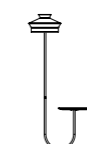

Calypso
62



Cube
92



Dorian
106



Flexiled
126



Mikado
172



Muse Lantern
184

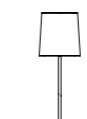

Ovale
22i



Tonda
26i



Up
228

Lampada da tavolo
Table lamp



Arcipelago
18



Asia
26



Athena
2i

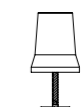

Audrey
34



Beam
46



Clessidra
80



Coco Mega & Deluxe
12i

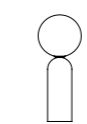

Emma
118



Mikado
172



Ongo
188

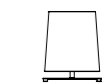

Ovale
22i



Treasure
224

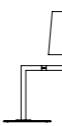

Tonda
26i



Up
228

Lampada da batteria
Battery lamp



G+T battery
144



Ongo
188



Tenebra
218

Air
Adam Tihany



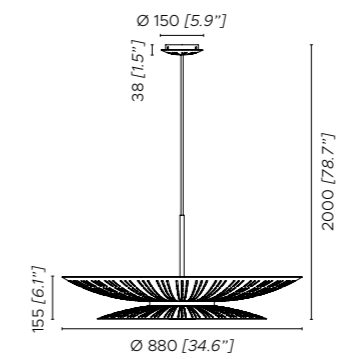



WHAT'S AIR?

The new eco-friendly AIR suspension light, conceived by the renowned **Adam Tihany**

Materiale **ecologico** "NPU GREEN"
100% riciclabile
100% sostenibile
Senza adesivi, coloranti e prodotti chimici
Atossica grazie alla finitura a base di acqua.

Air: per un impatto più sostenibile nel mondo del design

Eco-friendly material "NPU GREEN"
100% recyclable
100% sustainable
free of adhesives, dyes and chemicals
 The finishing is water-based and therefore **non-toxic**.

Air: for a more sustainable impact on the world of design



1.

2.

1. Materiale ecologico "NPU GREEN", laccato ciclo-eco bianco perla

2. Diffusore bianco opale

 *Altri colori disponibili su richiesta*

Fonte luminosa - Light source
 220-240V: 1 X 15W LED module
 110V: 1 X 15W LED module

*Dimmerabile DALI/Push - DALI/Push dimmable

*Compatibilità con altri sistemi di dimmerazione disponibili su richiesta -
 Compatibility with other dimming systems available on demand

1. Eco-friendly material "NPU GREEN", pearl white EcoSystem lacquered finish

2. Opal white diffuser

 *Other colours available on demand*



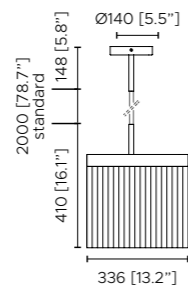



1. Struttura ottone satinato

- 2. Frange verde salvia
- 3. Frange blu nebbia
- 4. Frange cognac
- 5. Frange sabbia
- 6. Frange aragosta
- 7. Frange ruggine

Fonte luminosa - Light source
 220-240V: 1 x 12W Custom LED
 110V: 1 x 12W Custom LED

Ta - dimmerabile a tre intensità
 Ta - dimmable with three intensity levels

1. Satin brass frame

- 2. Sage green colour fringes
- 3. Fog blue colour fringes
- 4. Cognac colour fringes
- 5. Sand colour fringes
- 6. Aragosta colour fringes
- 7. Rust colour fringes

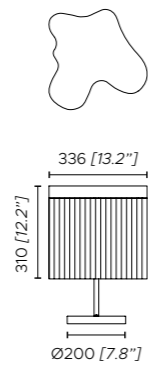

Asia
Federico Perri





- 1. Struttura nickel dorato satinato
- 2. Struttura bronzo-nickel spazzolato
- 3. Vetro trasparente

- 1. Satin gold nickel finish
- 2. Brushed bronze-nickel finish
- 3. Transparent glass

- 4. Paralume cotone bianco (esterno e interno)
- 5. Paralume cotone antracite (esterno)

- 4. White cotton shade (inside and outside)
- 5. Anthracite cotton shade (outside)

- 6. Diffusore vetro bianco opale

- 6. Opal white glass diffuser

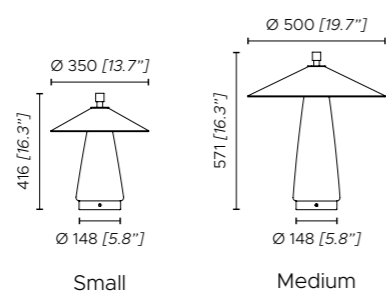

Fonte luminosa - Light source

220-240V: Ta small 1 x 13W Strip LED / Ta medium 1 x 20W Strip LED / So-Ap-PI 1 x 60W max COB LED
 110V: Ta small 1 x 13W Strip LED / Ta medium 1 x 20W Strip LED / So-Ap-PI 1 x 60W max COB LED

*So, ap, pl - dimmerabile DALI/Push / Ta - dimmerabile, interruttore push sulla base
 *So, ap, pl - DALI/Push dimmable / Ta - dimmable, push switch on the base

*Compatibilità con altri sistemi di dimmerazione disponibili su richiesta -
 Compatibility with other dimming systems available on demand

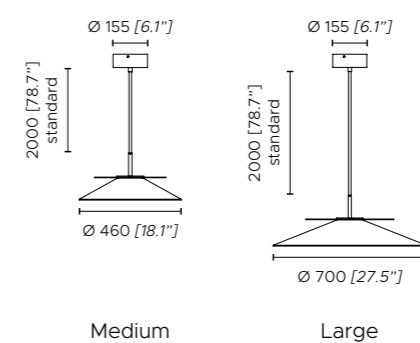
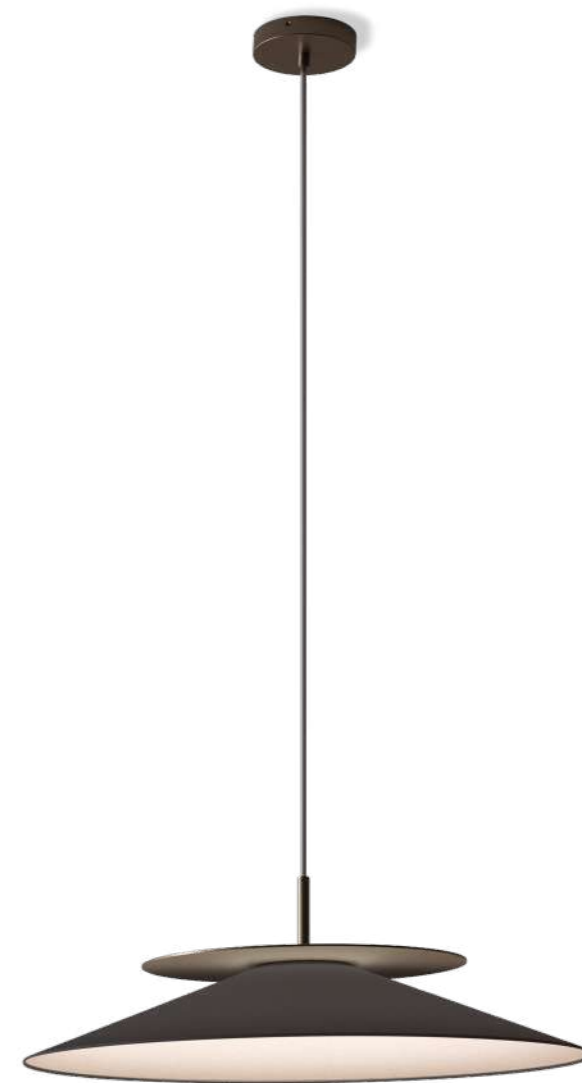

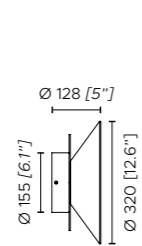

Ap/pi small

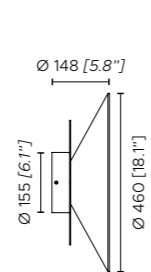

Ap/pi medium

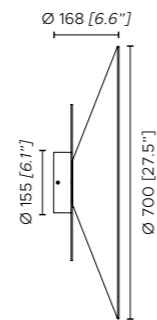

Ap/pi large



Audrey
Massimiliano Raggi



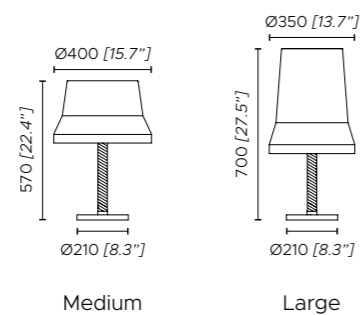

- 1. Base laccato nero lucido
- 2. Stelo in corda di seta intrecciata nera
- 3. Paralume cotone bianco
- 4. Bouclé color sabbia
- 5. Passamaneria in velluto senape
- 6. Passamaneria in velluto arancione
- 7. Passamaneria in velluto blu avio
- 8. Passamaneria in velluto nera

- 1. Glossy black lacquered base
- 2. Stem in black braided silk rope
- 3. White cotton shade
- 4. Sand colour bouclé
- 5. Mustard colour velvet trim
- 6. Orange colour velvet trim
- 7. Aviation blue colour velvet trim
- 8. Black colour velvet trim

Fonte luminosa - Light source
 220-240V: Ta 1 x 13W E27 LED / FI-So 3 x 14W E27 LED
 110V: Ta 1 x 13W E26 LED / FI-So 3 x 14W E26 LED

Ta - disponibile su richiesta versione con dimmer su cavo, compatibile solo con lampadine LED dimmerabili
 So - compatibile con sistemi di controllo remoto in caso di utilizzo di lampadine LED dimmerabili
 Ta - dimmer switch on the cable available on demand, compatible with dimmable LED light bulbs only
 So - compatible with remote control systems when dimmable LED bulbs are used

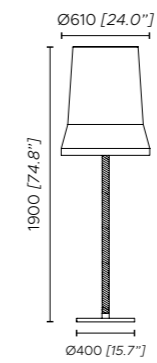

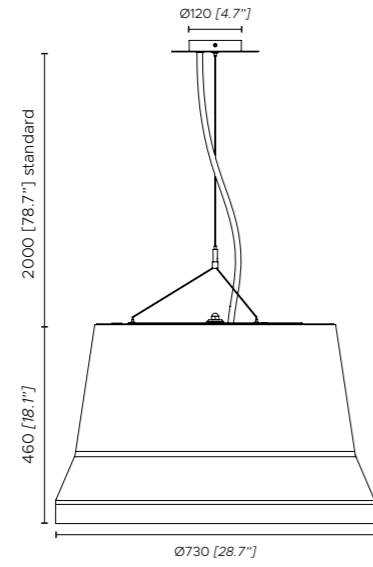

Bach

Massimiliano Raggi



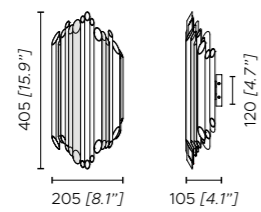

Small

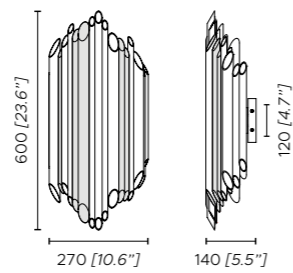

Large



- 1. Struttura laccato oro
- 2. Diffusore plexiglass satinato

Altri colori disponibili su richiesta

Fonte luminosa - Light source
 220-240V: 2 x 9W GU10 LED
 110V: 2 x 9W GU10 LED

Compatibile con sistemi di controllo remoto in caso di utilizzo di lampadine LED dimmerabili
 Compatible with remote control systems when dimmable LED bulbs are used

- 1. Matt gold lacquered frame
- 2. Satin plexiglass diffuser

Other colours available on demand

Beam

MKV Design



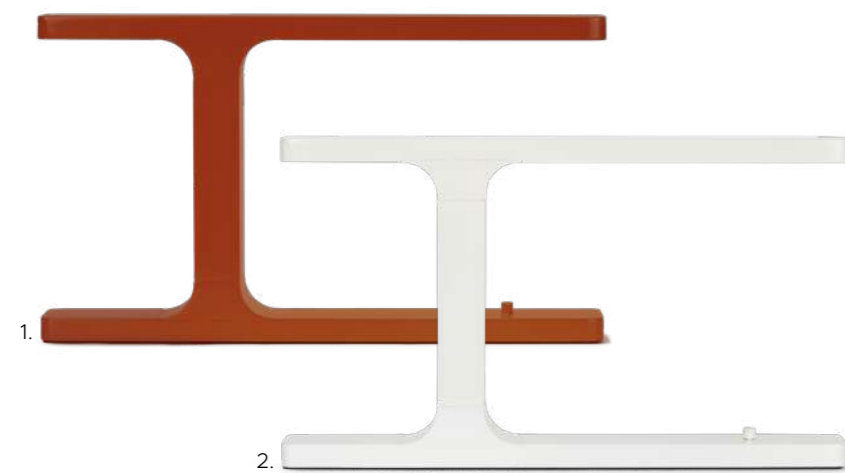

- 1. Laccato arancione scuro
- 2. Laccato bianco perla

Altri colori disponibili su richiesta

- 1. Dark orange lacquered finish
- 2. Pearl white lacquered finish

Other colours available on demand

Fonte luminosa - Light source

220-240V: 2 x 4W Strip LED - Luce orientabile (180°), tre posizioni: sinistra, destra, centrale - Comando sulla base
 110V: 2 x 4W Strip LED - adjustable light (180°), three positions: left, right and central - Switch on the base

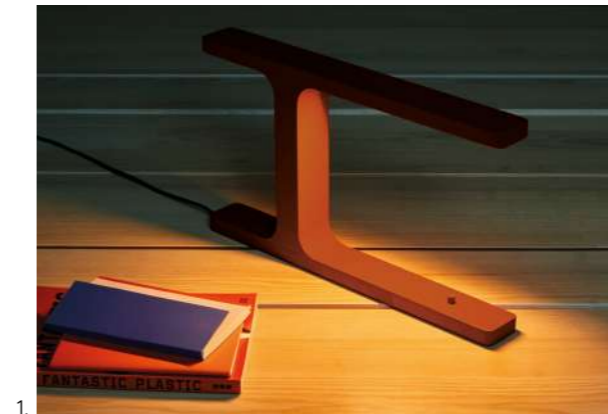

1.



2.



3.

NON MUOVERE LA LAMPADA, MUOVI LA LUCE

DO NOT
 MOVE THE
 LAMP,
**MUOVE
 THE
 LIGHT**

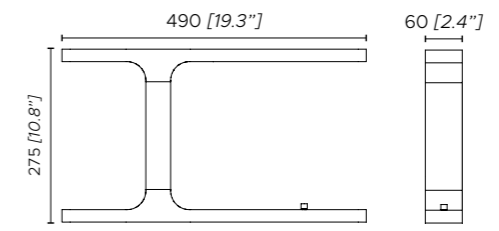

Belle
Staffan Tollgard



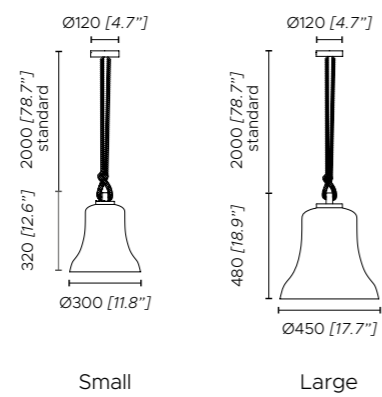

- 1. Ceramica bianco lucido
- 2. Corda in seta intrecciata grigia
- 3. Rosone laccato bianco
- 4. Ceramica grigio fango, interno avorio lucido
- 5. Ceramica bronzo lucido **(DELUXE)**
- 6. Corda in seta intrecciata marrone
- 7. Rosone bronzo spazzolato

- 1. Glossy white ceramic
- 2. Grey braided silk rope
- 3. Matt white lacquered canopy
- 4. Glossy mud grey coloured, polished ivory ceramic inside
- 5. Glossy bronze ceramic **(DELUXE)**
- 6. Brown braided silk rope
- 7. Satin bronze canopy

Fonte luminosa - Light source
 220-240V: 1 x 14W E27 LED
 110V: 1 x 14W E26 LED

Compatibile con sistemi di controllo remoto in caso di utilizzo di lampadine LED dimmerabili
 Compatible with remote control systems when dimmable LED bulbs are used

Bogotá

Massimiliano Raggi



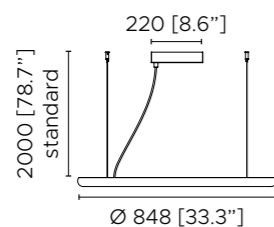

Small

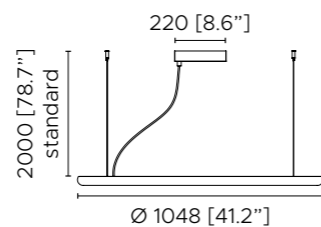

Large

1. Anello in legno tinto nero

2. Rivestimento diffusore in cotone bianco

3. Rivestimento diffusore in tessuto effetto marmo bianco Calacatta

4. Rivestimento diffusore in paglia di Vienna

1. Black stained wooden ring

2. White cotton diffuser

3. White Calacatta marble printed fabric diffuser

4. Vienna straw diffuser

Fonte luminosa - Light source

220-240V: Large 1 x 43W Panel LED - Small 1 x 35W Panel LED

110V: Large 1 x 43W Panel LED - Small 1 x 35W Panel LED

*Dimmerabile DALI/Push - DALI/Push dimmable

*Compatibilità con altri sistemi di dimmerazione disponibili su richiesta -
Compatibility with other dimming systems available on demand



EFFETTO **MARMO STAMPATO SU TESSUTO**
PRINTED MARBLE EFFECT ON FABRIC



PAGLIA DI VIENNA LAVORATA A MANO
HANDCRAFT VIENNA STRAW

Calypso

Servomuto







Calypso so



- 1. Struttura ottone satinato
- 2. Corda in seta intrecciata verde muschio
- 3. **Paralume SO**: Antigua, Guadaloupe, Martinique
- 4. Diffusore vetro trasparente

Fonte luminosa - Light source
 220-240V: 1 x 14W E27 LED
 110V: 1 x 14W E26 LED

Compatibile con sistemi di controllo remoto in caso di utilizzo di lampadine LED dimmerabili
 Compatible with remote control systems when dimmable LED bulbs are used

- 1. Satin brass frame
- 2. Moss green braided silk rope
- 3. **SO shade**: Antigua, Guadaloupe, Martinique
- 4. Transparent glass diffuser

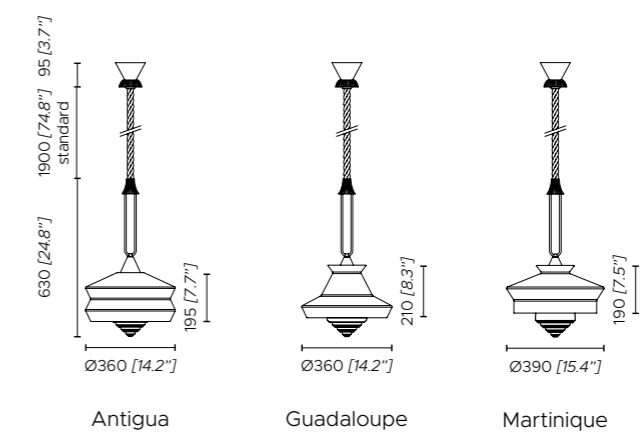





CALYPSO SO XL

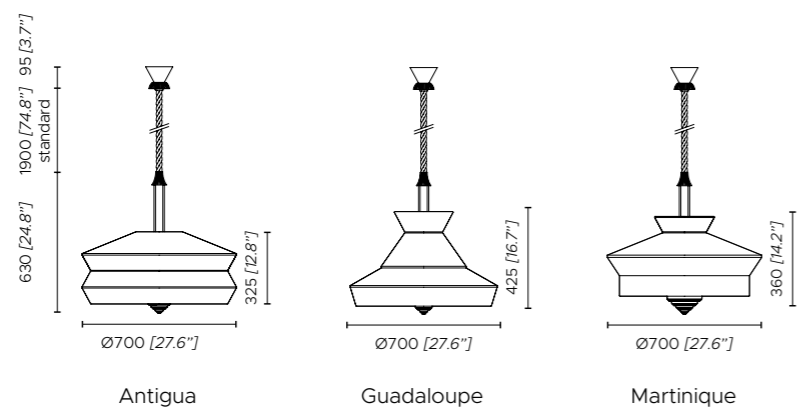

CALYPSO SO

CALYPSO SO XL



Antigua
Mint



Guadeloupe
Mint



Martinique
Yellow



Antigua
Mint



Antigua
Black



Guadeloupe
Black



Martinique
Black



Guadeloupe
Sale & Pepe



Antigua
Sale & Pepe



Guadeloupe
Sale & Pepe



Martinique
Building



Martinique
Yellow



CALYPSO
**FLOOR
+TABLE**
Servomuto

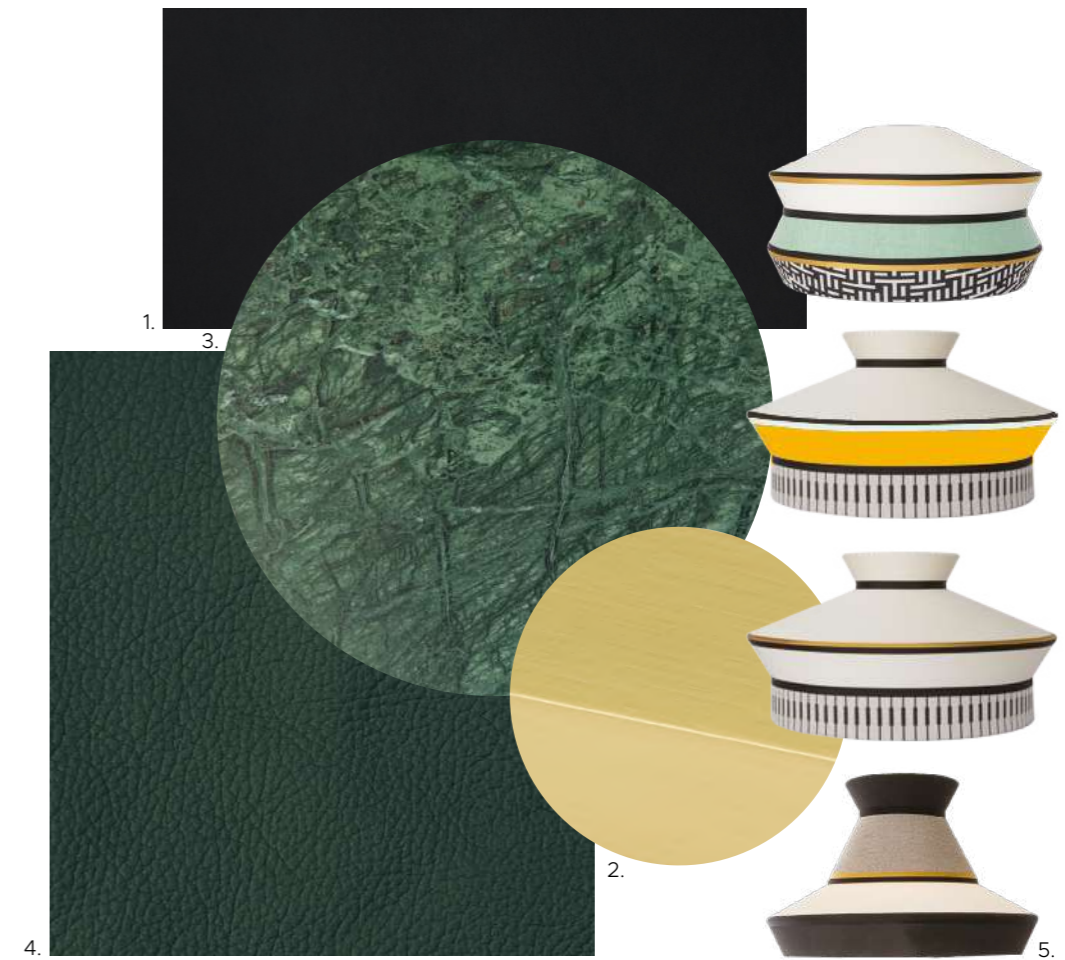
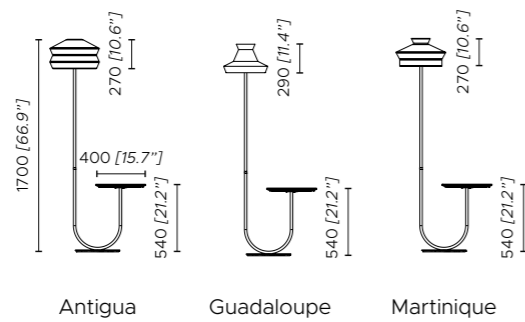

- 1. Struttura laccato nero seta opaco
- 2. Anello in ottone satinato
- 3. Marmo verde Guatemala
- 4. Pelle verde

5. **Paralume FL:** Antigua, Guadeloupe, Martinique

Fonte luminosa - Light source
 220-240V: 1 x 14W E27 LED
 110V: 1 x 14W E26 LED

Dimmerabile a piede
 Dimmable with foot control

- 1. Matt black silk lacquered frame
- 2. Satin brass ring
- 3. Green Guatemala marble
- 4. Green leather

5. **FL shade:** Antigua, Guadeloupe, Martinique

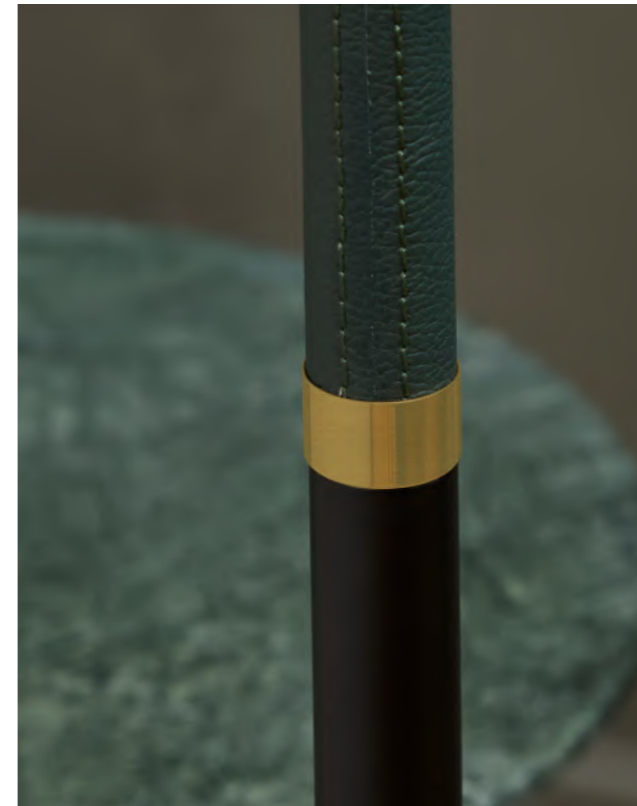

DETAILS
MATTER:
**LEATHER,
MARBLE,
BRASS**

I DETTAGLI CONTANO: PELLE, MARMO, OTTONE

Clessidra

Massimiliano Raggi



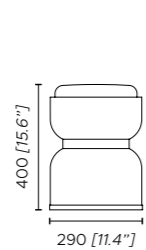

Kronos

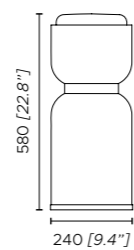

Kayros

1. Struttura bronzo-nickel spazzolato
2. Vetro soffiato metallizzato bronzo

3. Diffusore top superiore: vetro bianco lucido

1. Brushed bronze-nickel frame
2. Bronze metallized blown glass

3. Upper top diffuser: glossy white glass

Fonte luminosa - Light source

220-240V: 1 x 12W E27 LED + 1 x 10W E27 Filament LED
110V: 1 x 12W E26 LED + 1 x 10W E26 Filament LED

Doppio interruttore su cavo - Double switch on the cable



Cornelia & Messalina

Massimiliano Raggi





CORNELIA & MESSALINA

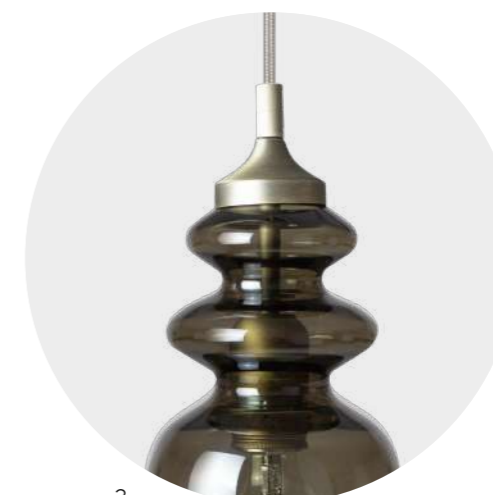
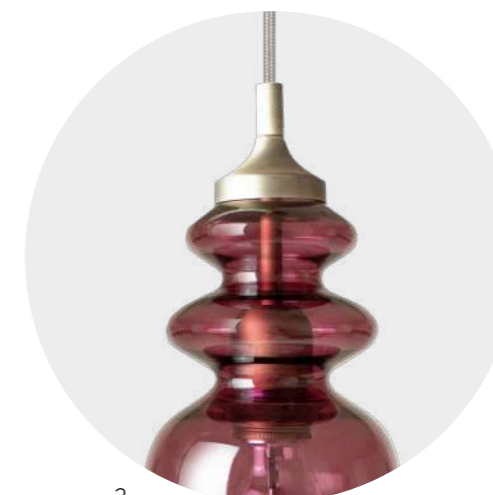

1. Diffusore vetro soffiato colore ambra scuro
2. Diffusore vetro soffiato colore ametista
3. Diffusore vetro soffiato colore fumé

4. Struttura nickel dorato satinato
5. Cavo tessuto color sabbia

1. Hand blown glass amber colour diffuser
2. Hand blown glass amethyst colour diffuser
3. Hand blown glass smoked grey colour diffuser

4. Satin golden nickel frame
5. Sand colour fabric cable

Fonte luminosa - Light source

220-240V: Cornelia 1 x 14W E27 LED / Messalina 1 x 12W E27 LED

110V: Cornelia 1 x 14W E26 LED / Messalina 1 x 12W E26 LED

Compatibile con sistemi di controllo remoto in caso di utilizzo di lampadine LED dimmerabili
Compatible with remote control systems when dimmable LED bulbs are used

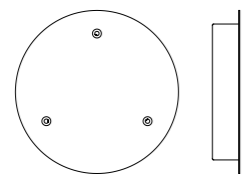

Cluster Ø300 mm
3 sospensioni
3 suspensions

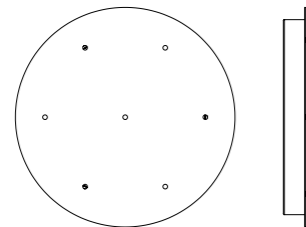

Cluster Ø500 mm
7 sospensioni
7 suspensions

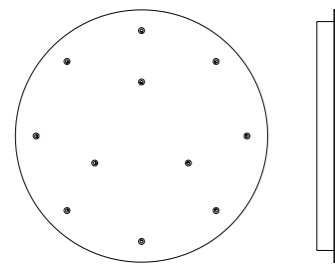

Cluster Ø700 mm
11 sospensioni
11 suspensions

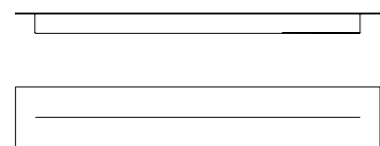

Cluster L.900 mm
Fino a 4 sospensioni
Up to 4 suspensions

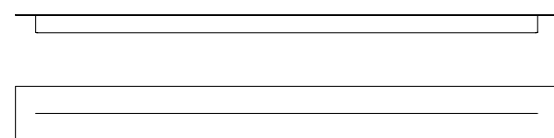

Cluster L.1500 mm
Fino a 7 sospensioni
Up to 7 suspensions

*(i) Altre composizioni su richiesta
Other compositions available on demand*



Cube

Massimiliano Raggi



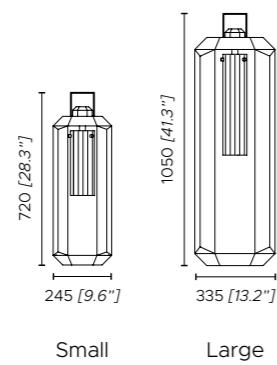

- 1. Struttura bronzo spazzolato
- 2. Interno laccato oro
- 3. Diffusore plexiglass rigato

- 1. Satin bronze frame
- 2. Gold lacquered inside
- 3. Striped plexiglass diffuser

Fonte luminosa - Light source
 220-240V: 1 x 14W E27 LED
 110V: 1 x 14W E26 LED

Dimmerabile a piede
 Dimmable with foot control



Discus

MKV Design

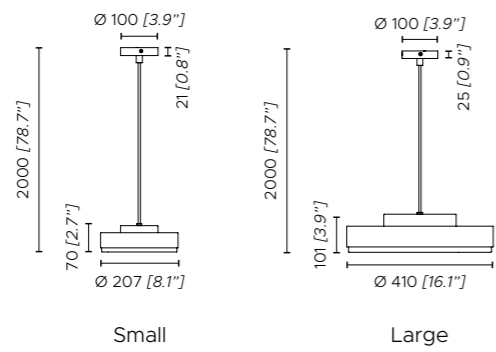
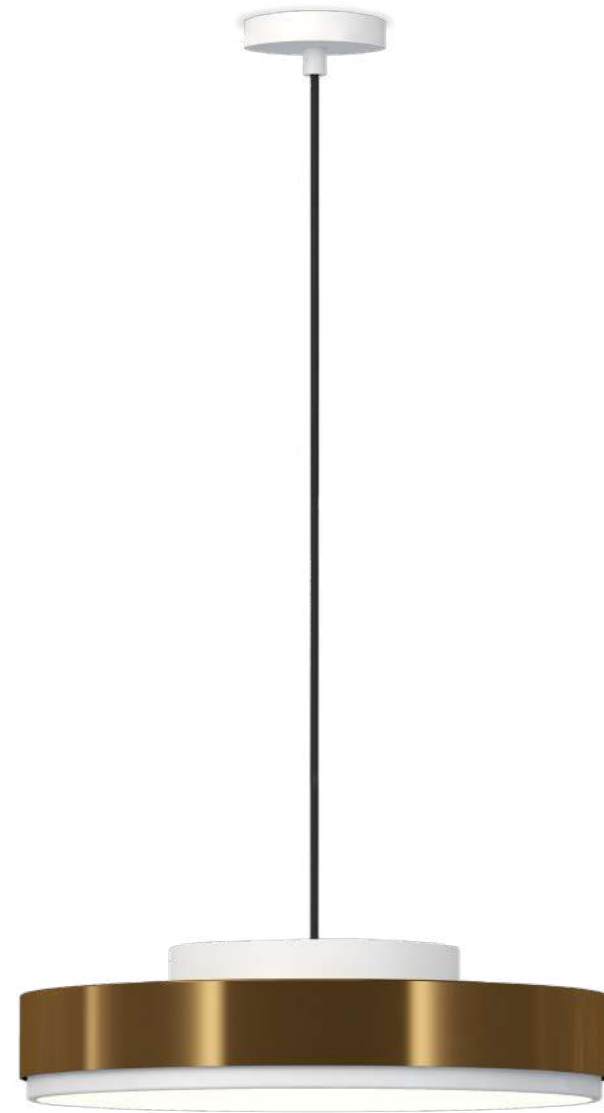

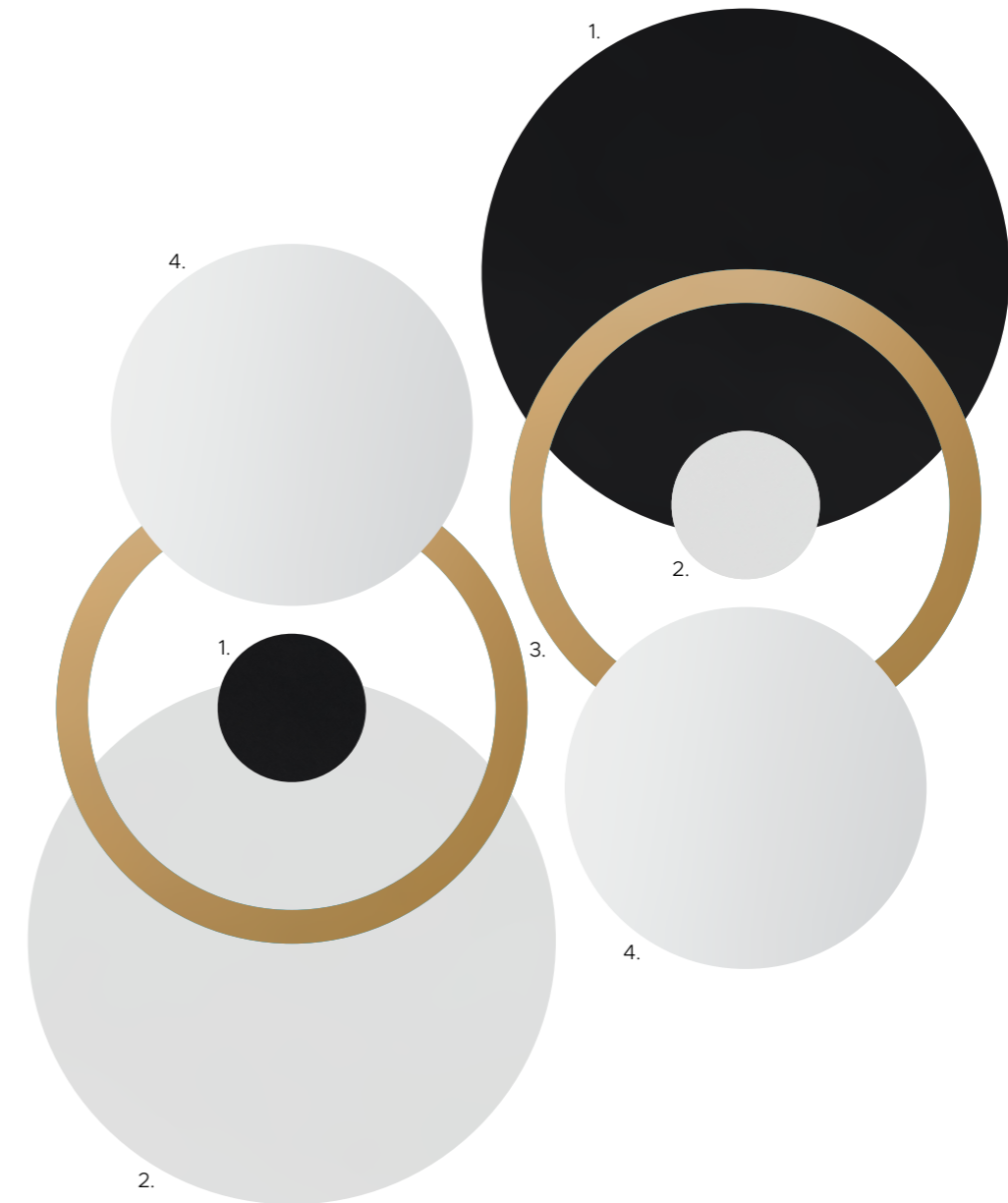
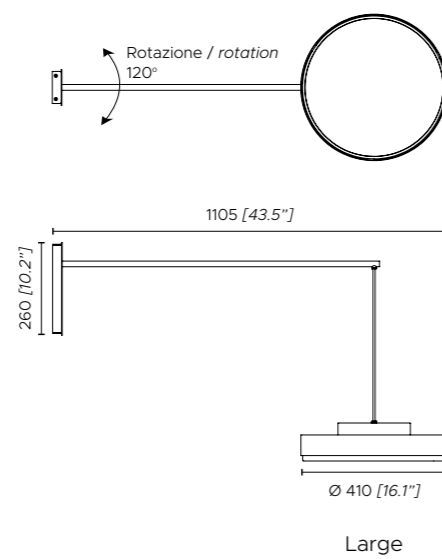

- 1. Laccato nero seta opaco
- 2. Laccato bianco opaco
- 3. Ottone semi-lucido
- 4. Diffusore bianco opaco

- 1. Matt black silk lacquered
- 2. Matt white lacquered
- 3. Semi-polished brass finish
- 4. Opal white diffuser

Fonte luminosa - Light source

220-240V: So-Ap-PI small 1 x 12.5W LED module / So-Ap-PI large 1 x 31.5W LED module
110V: So-Ap-PI small 1 x 12.5W LED module / So-Ap-PI large 1 x 31.5W LED module

*Dimmerabile DALI/Push - DALI/Push dimmable

*Compatibilità con altri sistemi di dimmerazione disponibili su richiesta -
Compatibility with other dimming systems available on demand

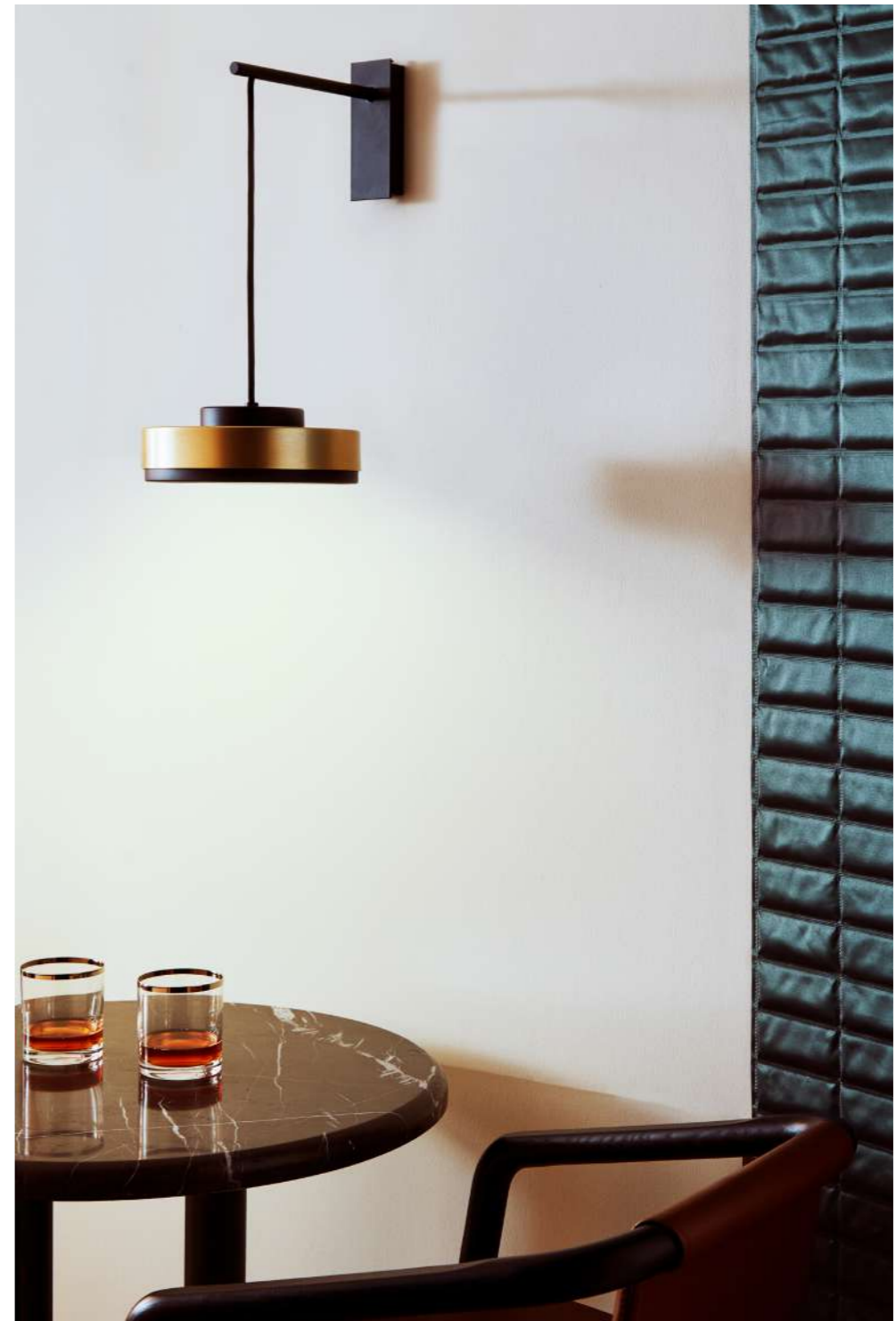
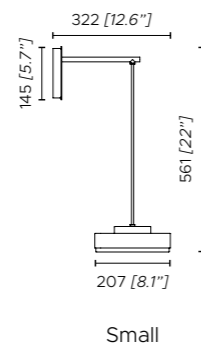

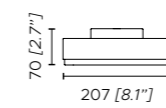

Small

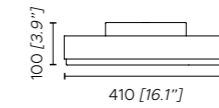

Large

Dorian
Marcello Colli



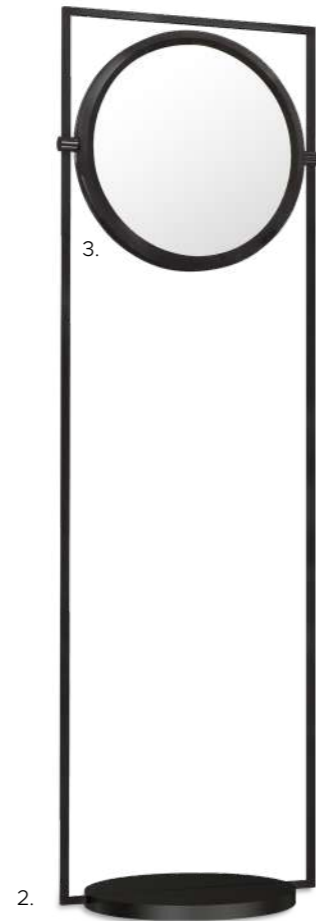

1. Struttura bronzo spazzolato chiaro opaco
2. Struttura laccato nero seta opaco

3. Diffusore: specchio fumè,
plexiglass con serigrafia a nido d'ape

1. Matt light satin bronze frame
2. Matt black silk lacquered

3. Diffuser: smoked coloured mirror, plexiglass
with honeycomb effect screen printing

Fonte luminosa - Light source

220-240V: FI 1 x 55W Custom LED / So small 1 x 17W Custom LED
110V: FI 1 x 55W Custom LED / So small 1 x 17W Custom LED

*So - dimmerabile DALI/Push / FI - dimmerabile a piede
*So - DALI /Push dimmable / FI - dimmable with foot control

*Compatibilità con altri sistemi di dimmerazione disponibili su richiesta -
Compatibility with other dimming systems available on demand

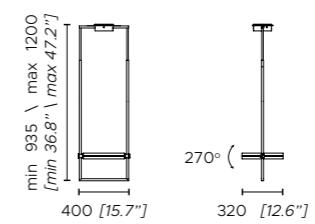

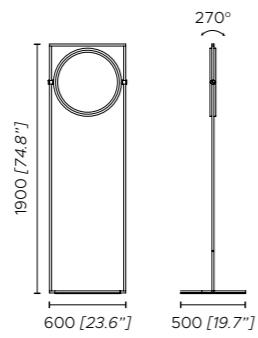

Eclisse 2.0

Massimiliano Raggi





1. Rosone bronzo spazzolato

2. Anello grande in legno bronzo scuro
3. Anelli piccoli in legno bronzo chiaro

4. Dischi diffusori in alicrite effetto alabastro

Fonte luminosa - Light source

220-240V: 1 x 25W Panel LED + 1 x 15W Panel LED
110V: 1 x 25W Panel LED + 1 x 15W Panel LED

*Dimmerabile DALI/Push - DALI/Push dimmable

*Compatibilità con altri sistemi di dimmerazione disponibili su richiesta -
Compatibility with other dimming systems available on demand

1. Satin bronze canopy

2. Larger ring in dark bronze painted wood
3. Smaller rings in light bronze painted wood

4. Alabaster effect alycrite discs diffusers

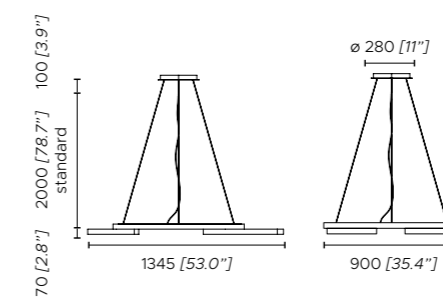

Emma
Contardi Studio



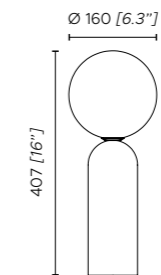

- 1. Marmo verde Guatemala
- 2. Marmo bianco Calacatta
- 3. Diffusore sfera bianca opale

- 1. Green Guatemala marble
- 2. White Calacatta marble
- 3. Opal white globe diffuser

Fonte luminosa - Light source

220-240V: Ap, pl 1 x 7W G9 LED / Ta 1 x 7W G9 LED dimmerabile - dimmable
 110V: Ap, pl 1 x 7W G9 LED / Ta 1 x 7W G9 LED dimmerabile - dimmable

Ap, pl - compatibile con sistemi di controllo remoto in caso di utilizzo di lampadine LED dimmerabili
 Ta - dimmerabile su cavo
 Ap, pl - compatible with remote control systems when dimmable LED bulbs are used
 Ta - dimmable on the cable

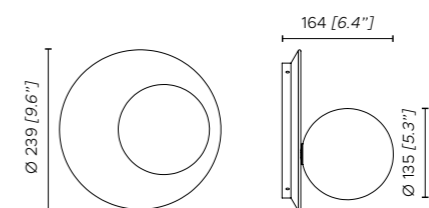
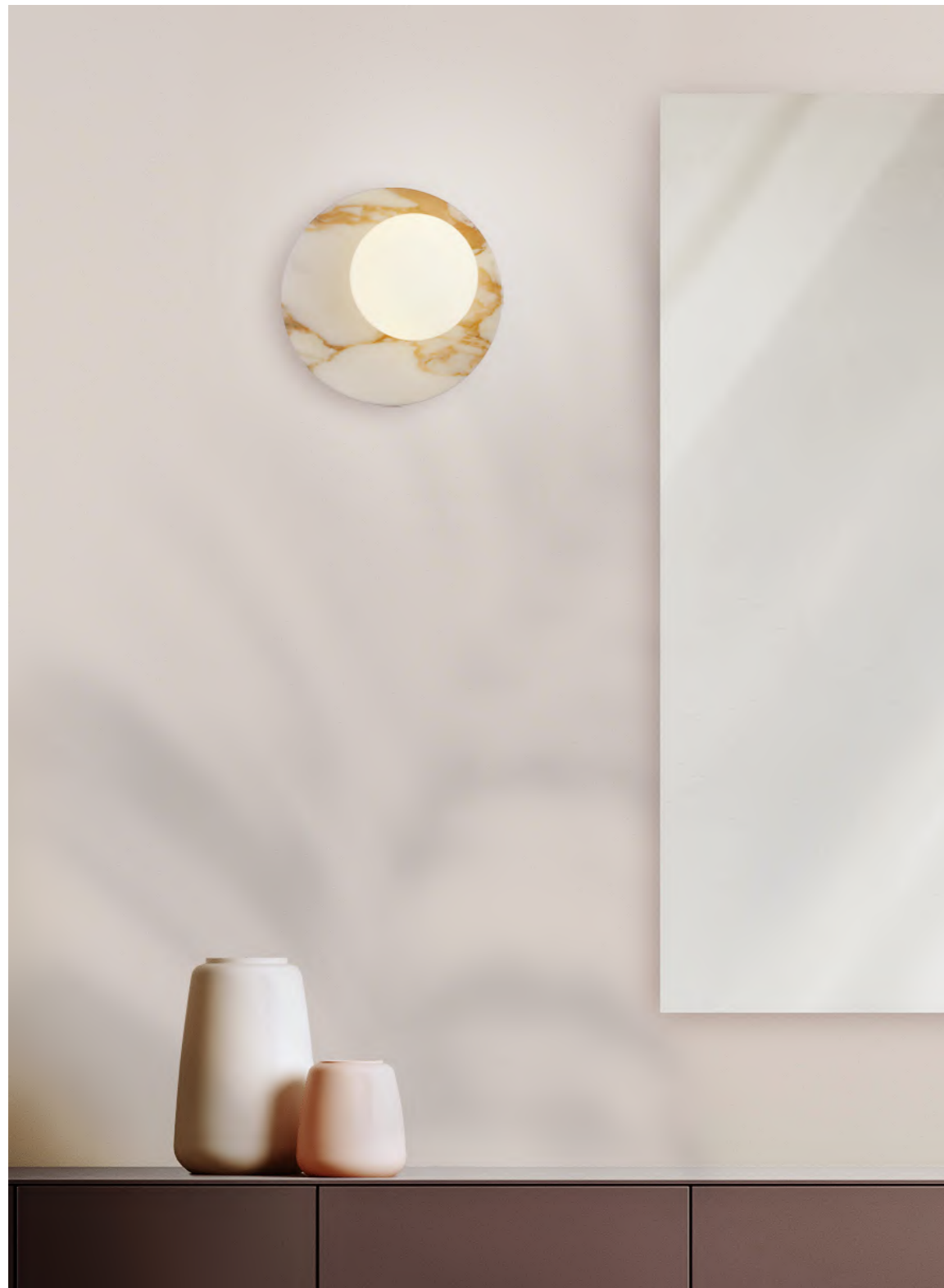

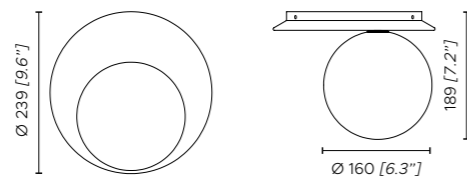

Flexiled

King & Roselli



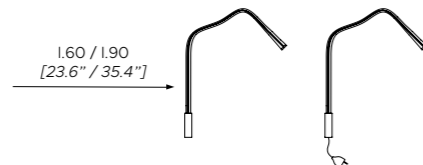

- 1. Base laccato nero seta opaco (FI)
- 2. Base bronzo spazzolato
- 3. Base nickel satinato
- 4. Maglia d'acciaio intrecciato
- 5. Pelle avorio
- 6. Pelle marrone testa di moro
- 7. Pelle nera

- 1. Matt black silk lacquered base (FI)
- 2. Satin bronze base
- 3. Satin nickel base
- 4. Braided steel mesh
- 5. Ivory leather
- 6. Dark brown leather
- 7. Black leather

Fonte luminosa - Light source
 220-240V: Ap 1 x 3W LED module / FI 1 x 7W LED module
 110V: Ap 1 x 3W LED module / FI 1 x 7W LED module

FI - dimmerabile a piede
 FI - dimmable with foot control

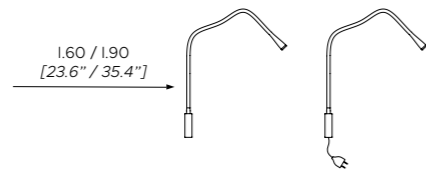
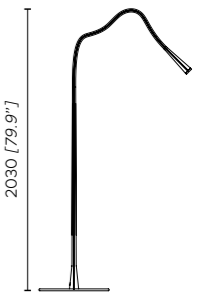



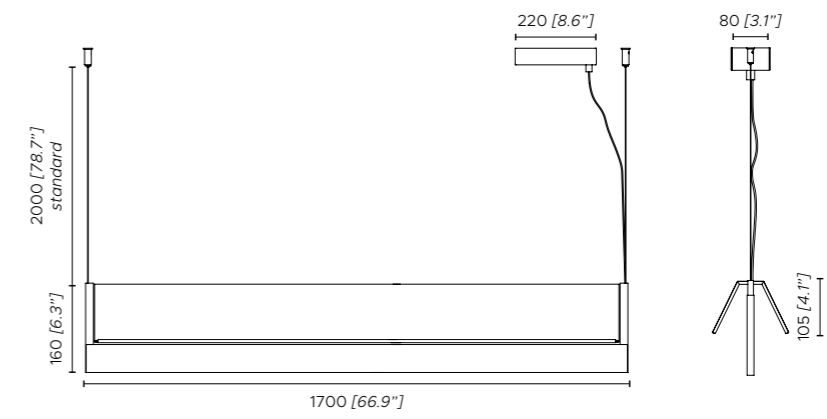
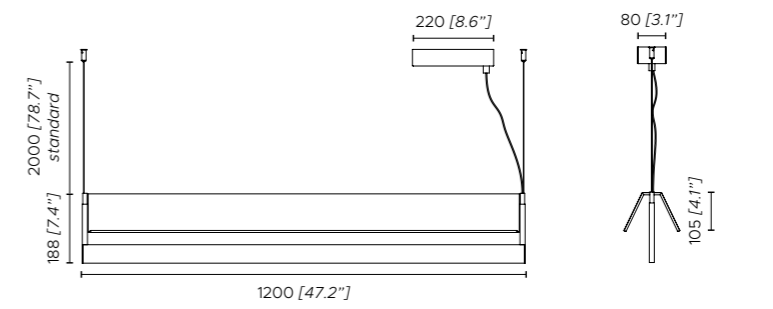

DOPPIA EMISSIONE: LUCE DIRETTA E INDIRETTA
DOUBLE EMISSION: DIRECT AND INDIRECT LIGHT



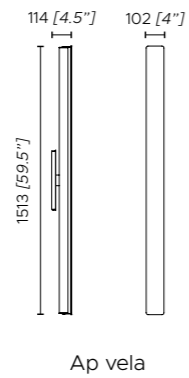
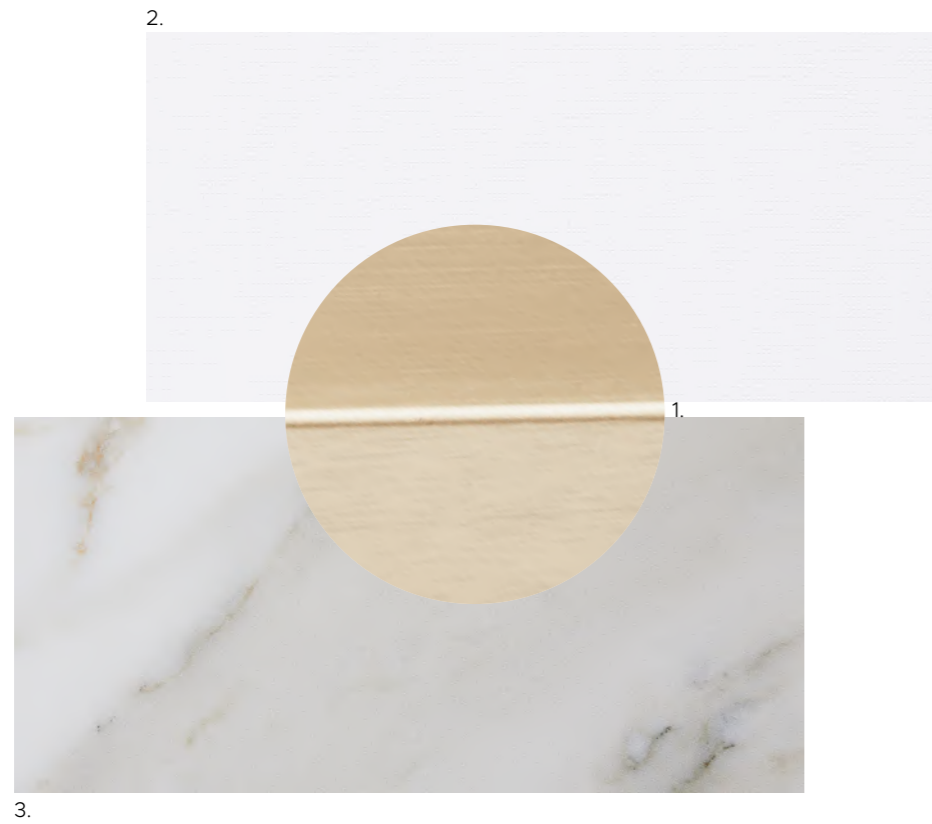

Ap vela

- 1. Struttura nickel dorato satinato
- 2. Cotone bianco
- 3. Tessuto effetto marmo bianco Calacatta

- 1. Satin golden nickel finish
- 2. White cotton
- 3. White Calacatta marble printed fabric

Fonte luminosa - Light source

110-240V:

Ap I.150 fronte/front 1 x 21W Strip LED, Retro/back 1 x 21 Strip LED

So I.120 Superiore/upper 1 x 17W Strip LED, Inferiore/lower 1 x 23W Strip LED

So I.150 Superiore/upper 1 x 24W Strip LED, Inferiore/lower 1 x 33W Strip LED

Picture 1 x 12W Strip LED

*Dimmerabile DALI/Push - DALI/Push dimmable

*Compatibilità con altri sistemi di dimmerazione disponibili su richiesta -
Compatibility with other dimming systems available on demand

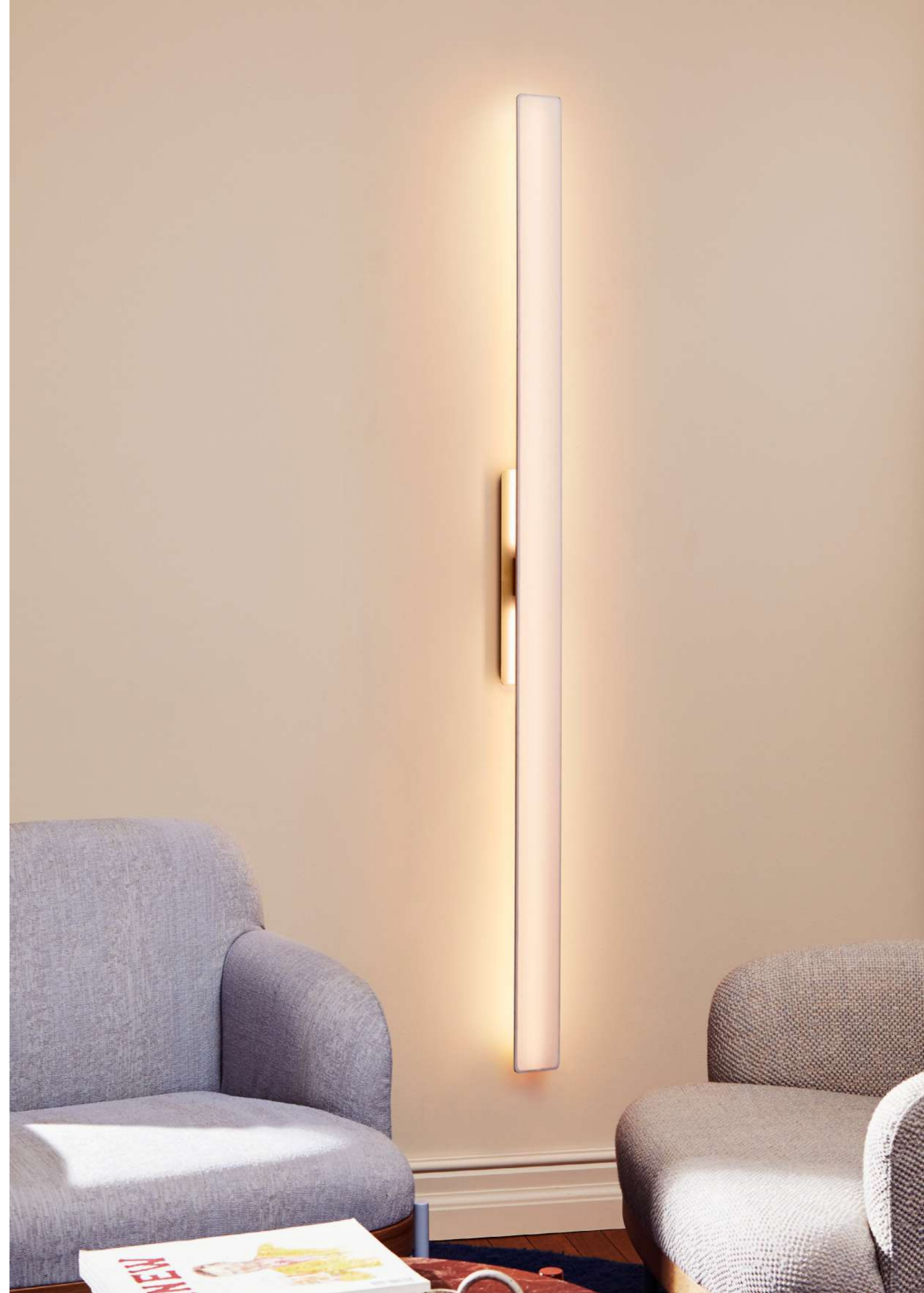

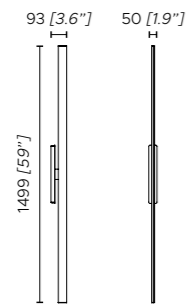

Ap

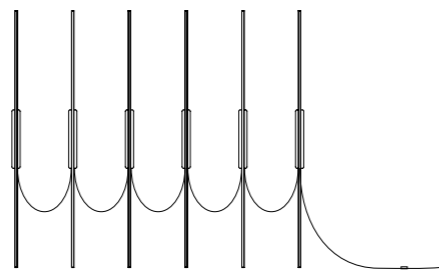

Composizione esempio Fly ap (max. 5 lampade) /
Example of Fly ap **modular system** (max. 5 lamps)

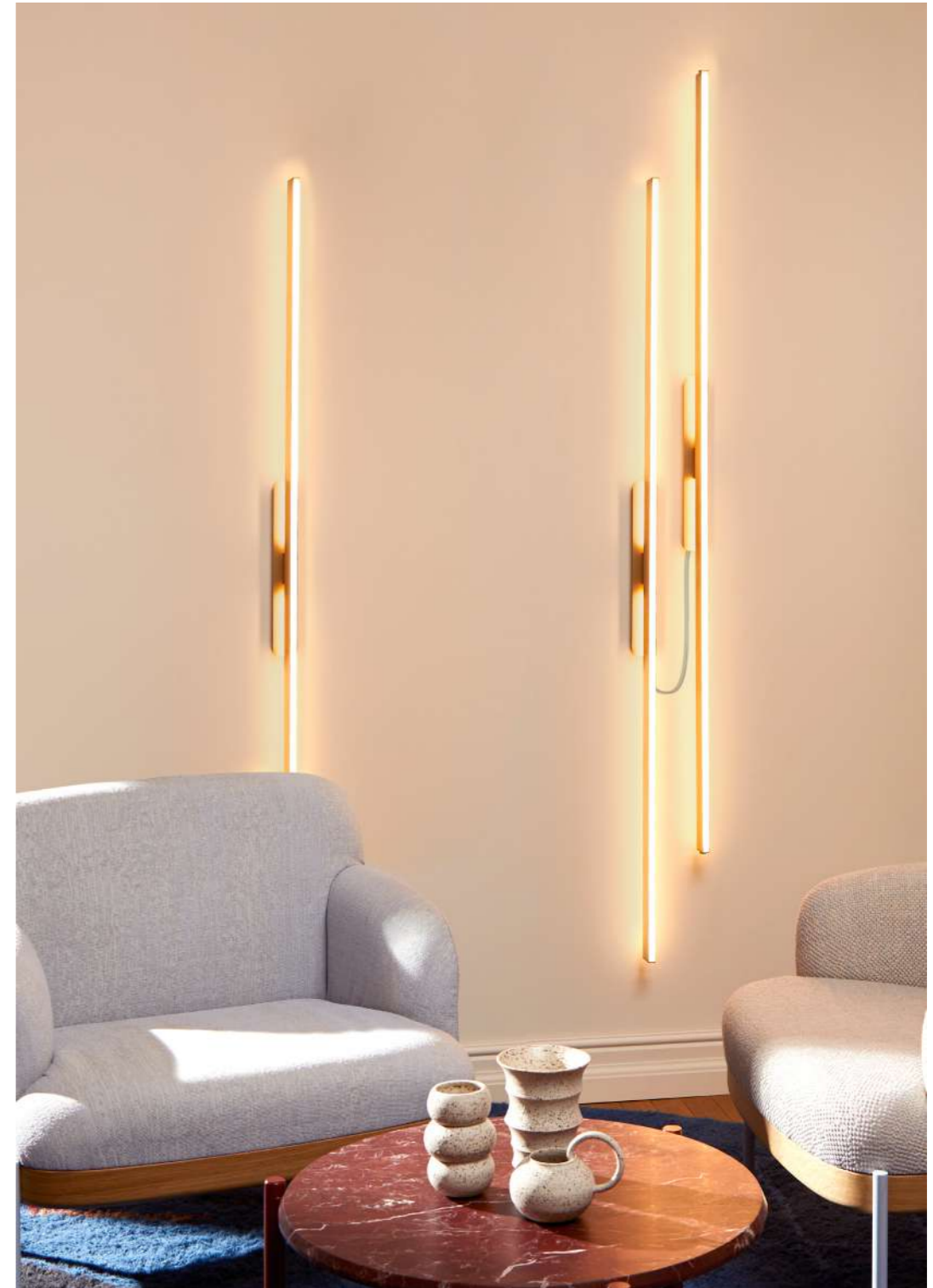

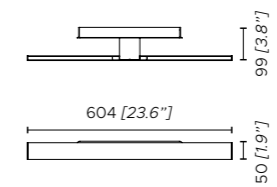

Picture

G+T

Jan Van Lierde



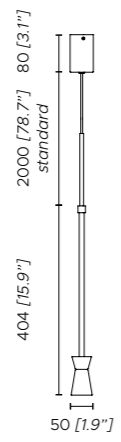

VERSIONE CABLATA / WIRED VERSION



Porta USB per ricaricare dispositivi elettronici
USB port for charging electronic devices

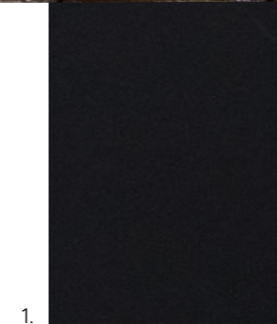
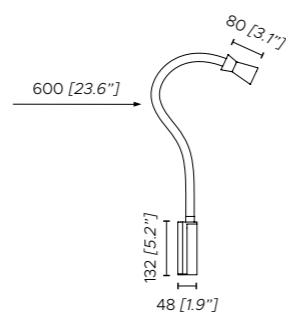

- 1. Laccato nero seta opaco (so - reading)
- 2. Bronzo rame lucido
- 3. Nickel lucido

- 4. Pelle intrecciata marrone testa di moro

Fonte luminosa - Light source

220-240V: Ap-Battery 1 x 3W LED module / Reading-So 1 x 3W LED module
110V: Ap-Battery 1 x 3W LED module / Reading-So 1 x 3W LED module

Ap, battery - dimmerabile, comando a tre livelli (100 - 70 - 30%)
Ap, battery - dimmable, three levels control (100 - 70 - 30%)

- 1. Matt black silk lacquered (so - reading)
- 2. Polished copper bronze
- 3. Polished nickel

- 4. Dark brown braided leather



VERSIONE **A BATTERIA** / **BATTERY OPERATED VERSION**

FISSAGGIO PER **TAVOLO**

TABLE FIXING ACCESSORY

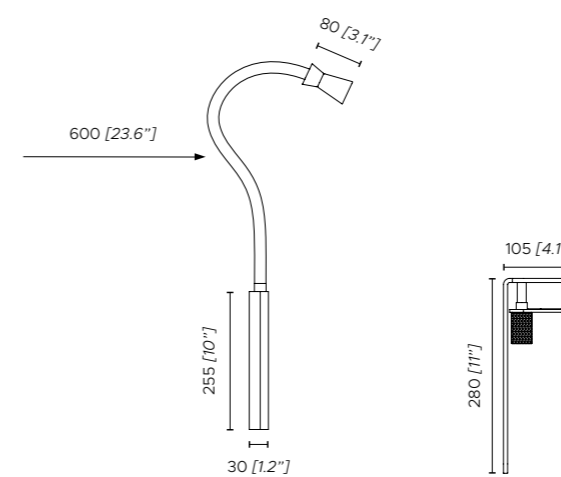

Dimmerabile: 3 intensità (100 - 70 - 30%)
Dimmable: 3 steps (100 - 70 - 30%)

VERSIONE A BATTERIA / BATTERY OPERATED VERSION



FISSAGGIO A PARETE

WALL FIXING ACCESSORY

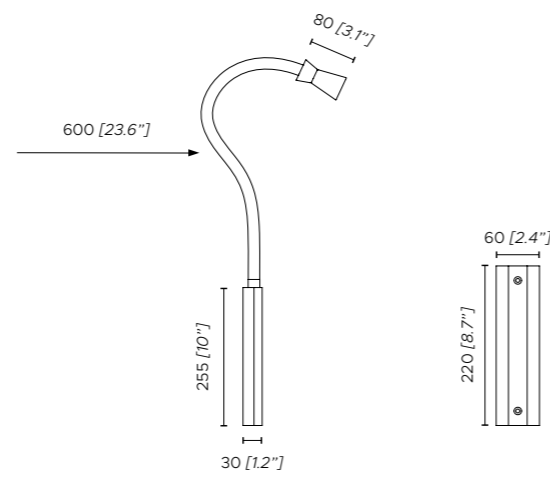

Dimmerabile: 3 intensità (100 - 70 - 30%)
Dimmable: 3 steps (100 - 70 - 30%)





VERSIONE **A BATTERIA** / **BATTERY OPERATED VERSION**

FISSAGGIO PER **POLTRONE E DIVANI**

SEATS & SOFAS FIXING ACCESSORY

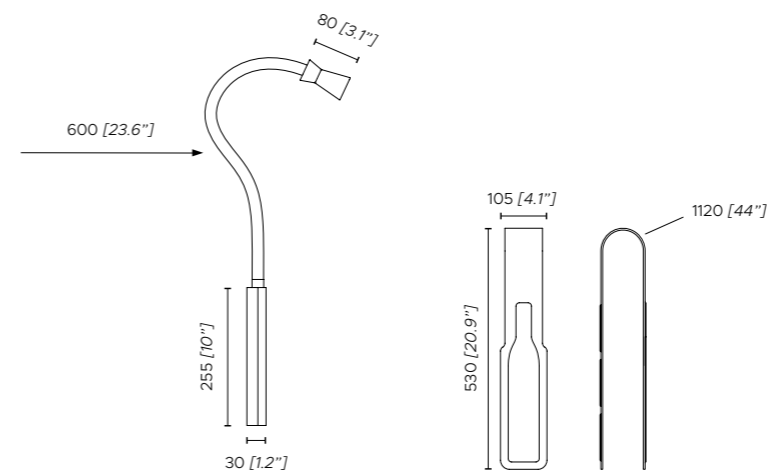

Dimmerabile: 3 intensità (100 - 70 - 30%)
Dimmable: 3 steps (100 - 70 - 30%)

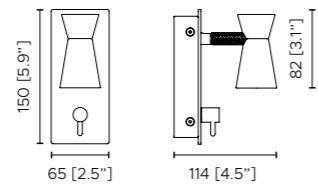

Kubric

Massimiliano Raggi



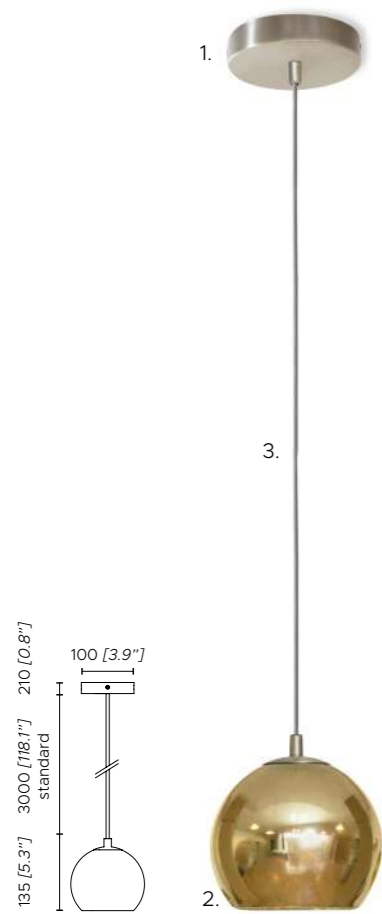

1. Struttura nickel dorato satinato

2. Vetro bronzo lucido con interno oro
3. Cavo tessuto color sabbia

ⓘ Altri colori su richiesta

Fonte luminosa - Light source
220-240V: 1 x 5W LED module
110V: 1 x 5W LED module

Compatibile con dimmerazione a taglio di fase
Compatible with phase dimming

1. Satin gold nickel finish

2. Polished bronze glass with gold painted inside
3. Sand colour fabric cable

ⓘ Other colours available on demand

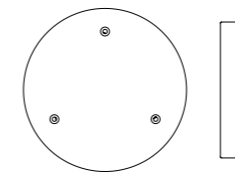

Cluster Ø300 mm
3 sospensioni
3 suspensions

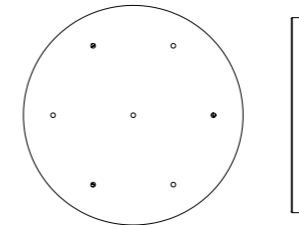

Cluster Ø500 mm
7 sospensioni
7 suspensions

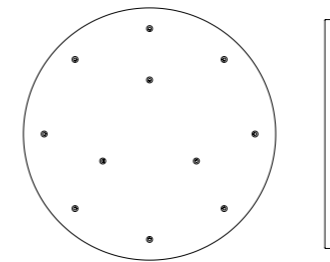

Cluster Ø700 mm
11 sospensioni
11 suspensions

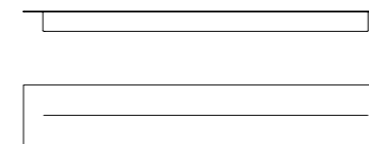

Cluster L.900 mm
Fino a 6 sospensioni
Up to 6 suspensions

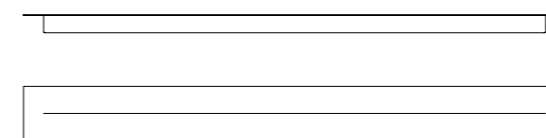

Cluster L.1500 mm
Fino a 10 sospensioni
Up to 10 suspensions

ⓘ Altre composizioni su richiesta
Other compositions available on demand

Manhattan

Contardi Studio



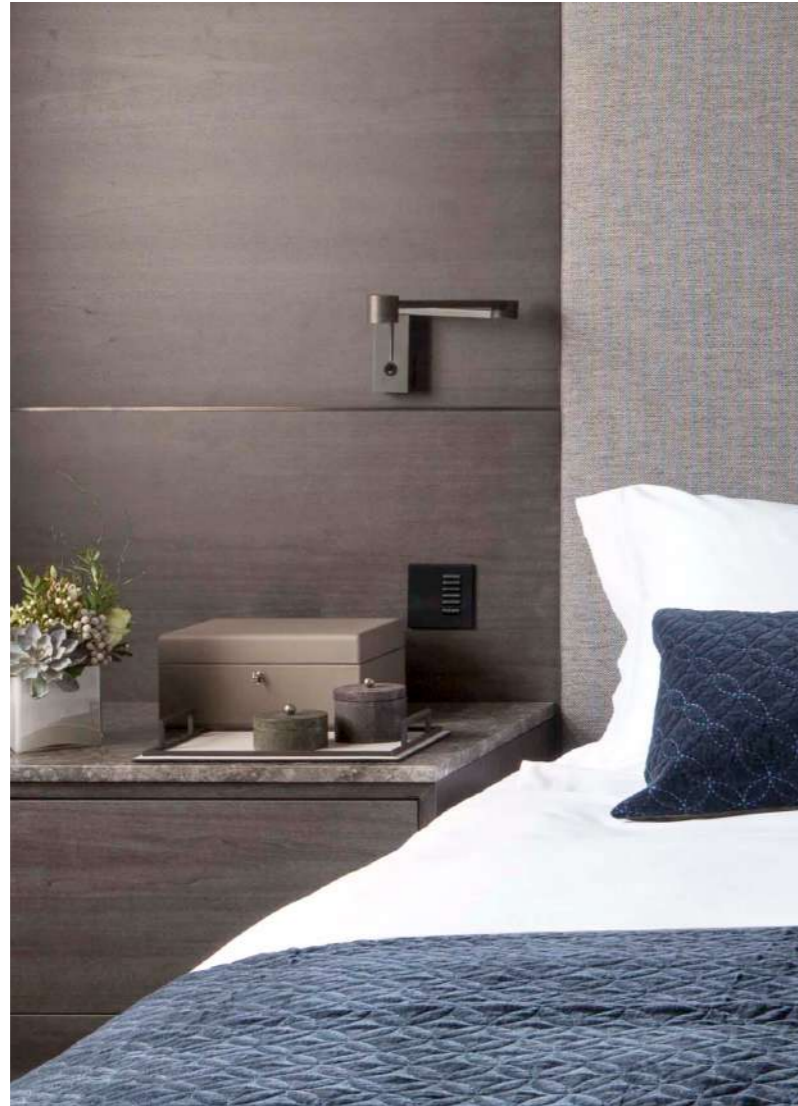

APRI / OPEN

RUOTA / TURN

CHIUDI / CLOSE

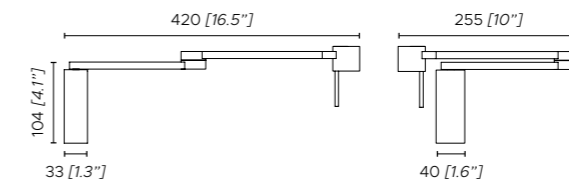

- 1. Bronzo spazzolato
- 2. Nickel satinato

- 1. Satin bronze
- 2. Satin nickel

Fonte luminosa - Light source
 220-240V: 1 3W LED module
 110V: 1 x 3W LED module



Melanocetus

Tristan Auer

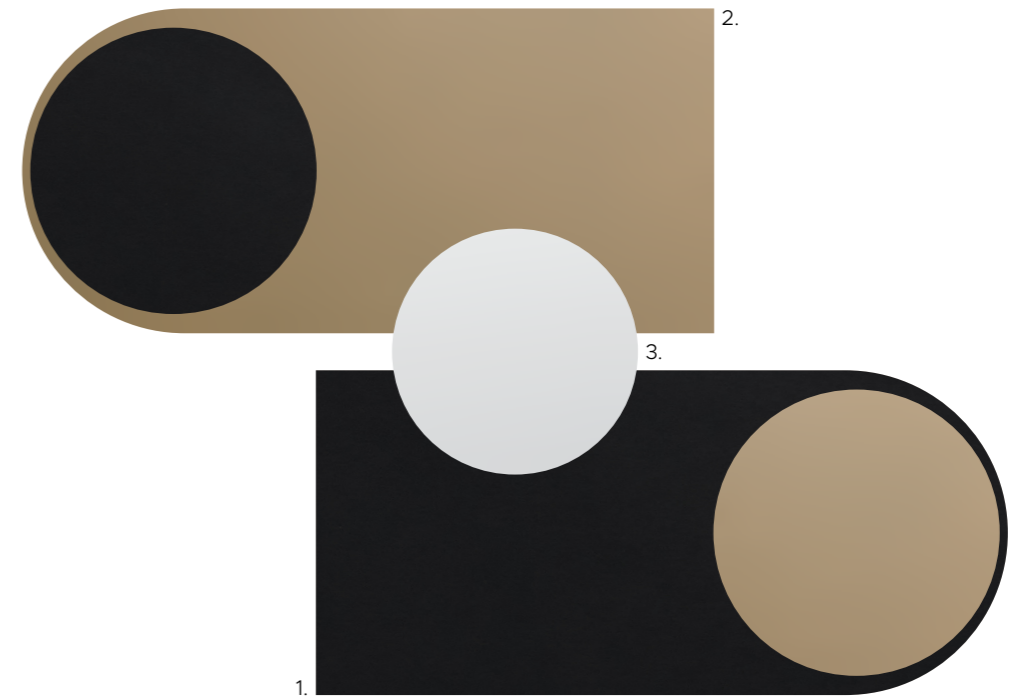

1. Nero opaco con dettagli oro satinato
2. Oro satinato con dettagli nero opaco

3. Diffusore: plexiglass satinato

1. Matt black lacquered with satin gold details
2. Satin gold finish with matt black lacquered details

3. Diffuser: satin plexiglass

Fonte luminosa - Light source

220-240V: PI 2 x 7.5W GU10 LED / PI Double 4 x 7.5W GU10 LED
110V: PI 2 x 7.5W GU10 LED / PI Double 4 x 7.5W GU10 LED

Compatibile con sistemi di controllo remoto in caso di utilizzo di lampadine LED dimmerabili
Compatible with remote control systems when dimmable LED bulbs are used

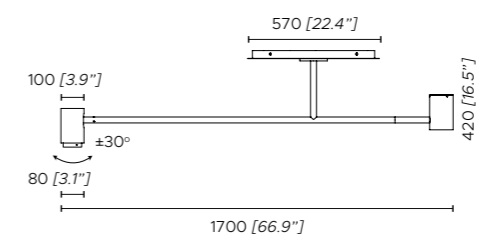

PI

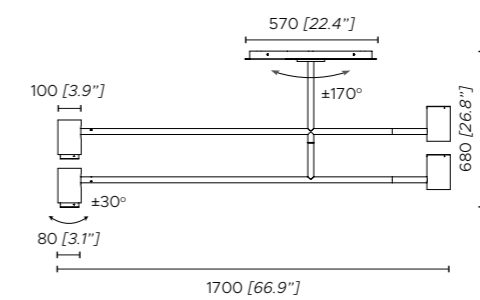

PI double

Mikado

Massimiliano Raggi



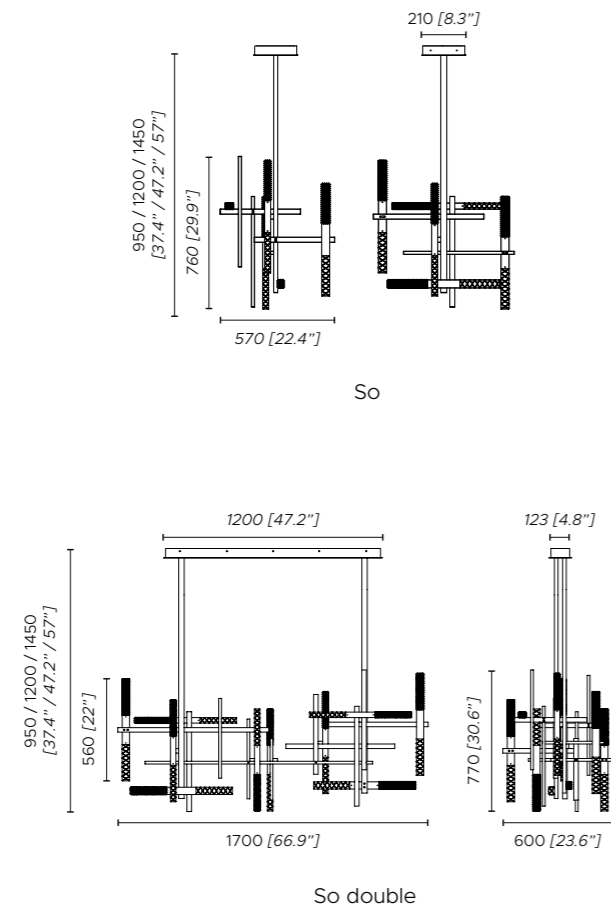

Fonte luminosa - Light source

220-240V: So 10 x 4W LED module / So double 20 x 4W LED module
 110V: So 10 x 4W LED module / So double 20 x 4W LED module

*So, so double dimmerabile DALI/Push - DALI/Push dimmable

*Compatibilità con altri sistemi di dimmerazione disponibili su richiesta -
 Compatibility with other dimming systems available on demand

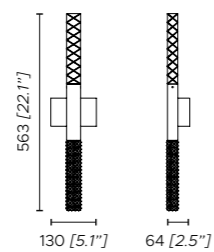

Ap solo/2



1.



3.



2.

1. Ottone satinato

2. Cristallo trasparente inciso

3. Cristallo trasparente prismatic

1. Satin brass

2. Transparent engraved crystal diffuser

3. Transparent prismatic crystal diffuser

Fonte luminosa - Light source

220-240V: Ap solo/2 2 x 4W LED module

110V: Ap solo/2 2 x 4W LED module

*Dimmerabile DALI/Push - DALI/Push dimmable

*Compatibilità con altri sistemi di dimmerazione disponibili su richiesta -
Compatibility with other dimming systems available on demand

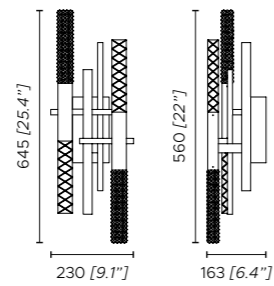
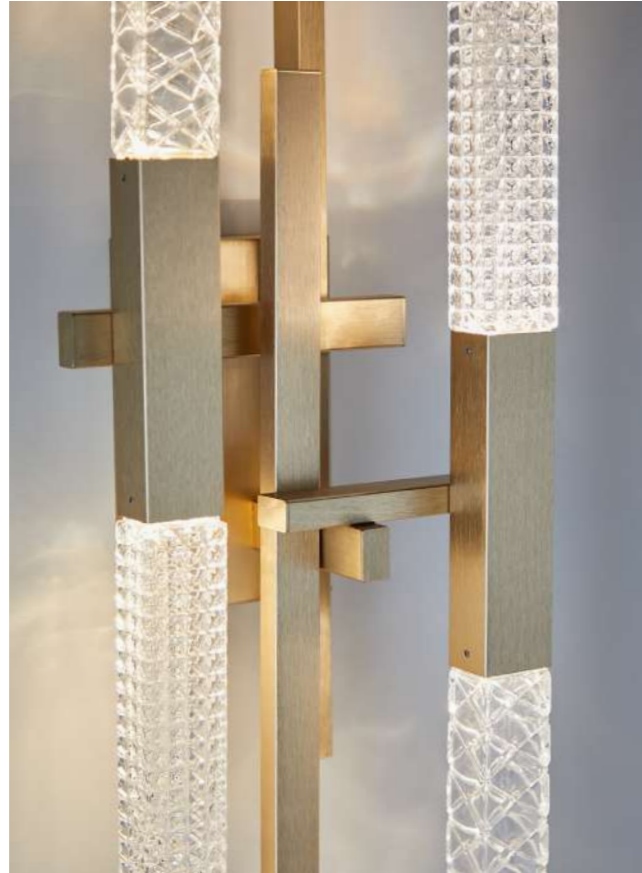

Ap

Fonte luminosa - Light source
220-240V: Ap 4 x 4W LED module
110V: Ap 4 x 4W LED module

*Dimmerabile DALI/Push - DALI/Push dimmable

*Compatibilità con altri sistemi di dimmerazione disponibili su richiesta -
Compatibility with other dimming systems available on demand

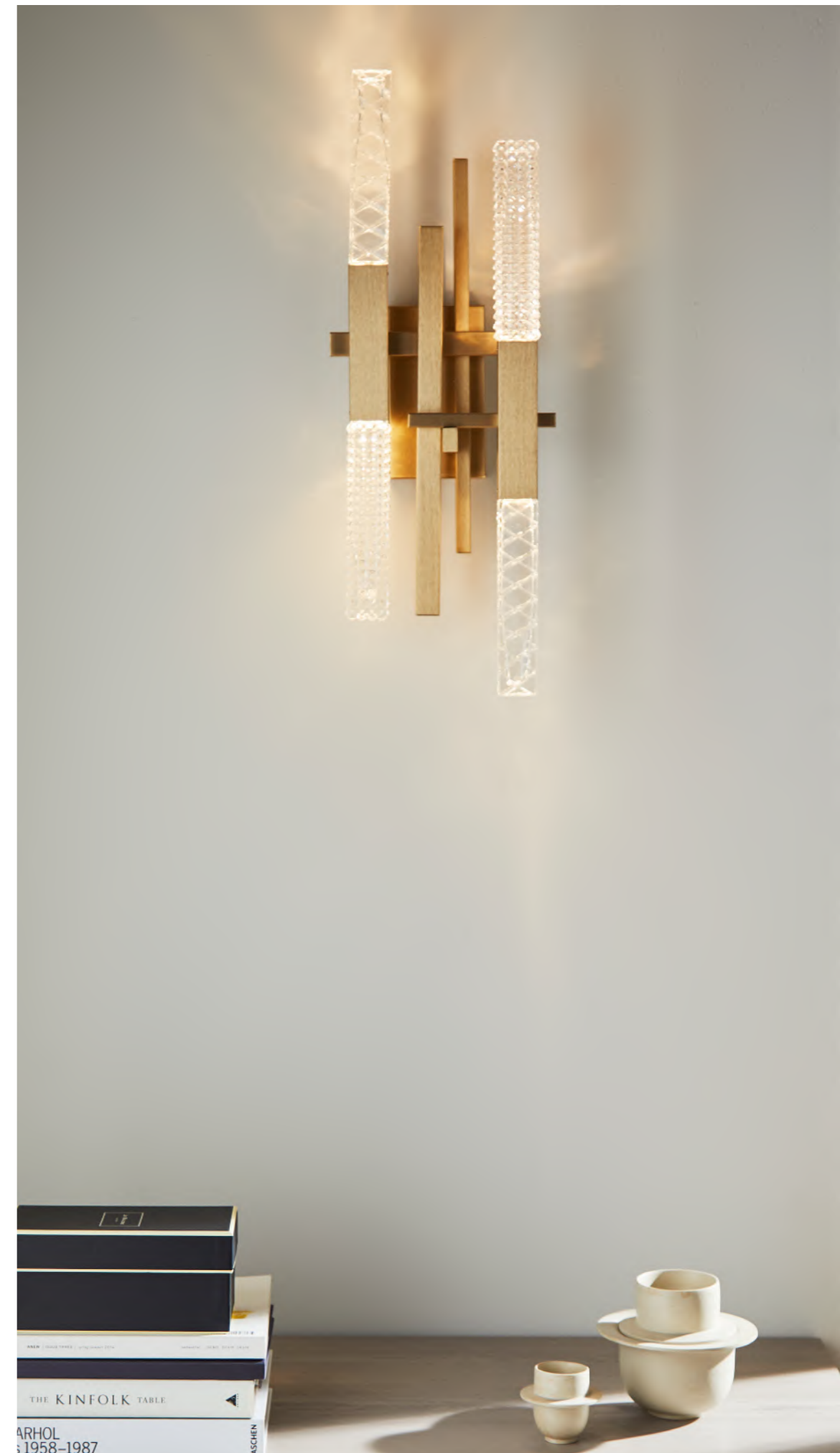

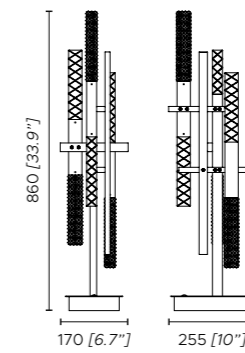

Fonte luminosa - Light source

220-240V: Ta 6 x 4W LED module

110V: Ta 6 x 4W LED module

Dimmerabile su base a tre livelli d'intensità (100 - 70 - 30%)

Dimmable with three intensity levels (100 - 70 - 30%) on the base

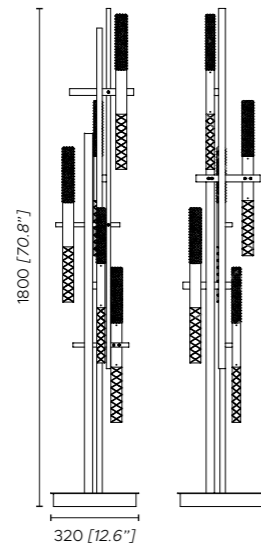

Fonte luminosa - Light source
220-240V: FI 10 x 4W LED module
110V: FI 10 x 4W LED module

Dimmerabile a piede
Dimmable with foot control

Muse Lantern

Tristan Auer





- 1. Struttura bronzo spazzolato
- 2. Maniglia in seta intrecciata color miele
- 3. Diffusore acrilico color ambra

Fonte luminosa - Light source
 220-240V: 1 x 10W E27 Classic Deco LED
 110V: 1 x 10W E26 Classic Deco LED

Interruttore a piede
 Foot switch

Disponibile su richiesta versione con dimmer a piede, compatibile solo con lampadine LED dimmerabili
 Foot dimmer available on demand, compatible with dimmable LED light bulbs only

- 1. Satin bronze frame
- 2. Honey-coloured braided silk handle
- 3. Amber acrylic diffuser

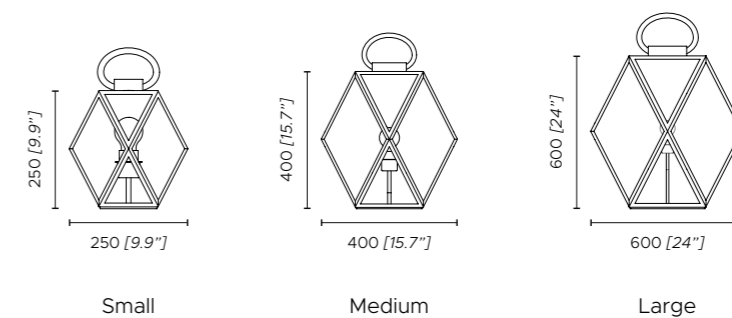

Ongo
Jessica Corr for Tzelan



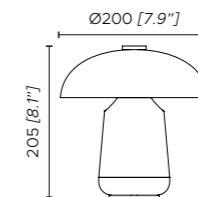

1. Laccato arancione scuro
2. Laccato oro satinato
3. Laccato nickel caldo

4. Vetro soffiato bianco

Fonte luminosa - Light source
 220-240V: 1 x 3.5W LED module
 110V: 1 x 3.5W LED module

Dimmerabile, due intensità
 Dimmable, two intensity levels

1. Dark orange lacquered
2. Satin gold lacquered
3. Warm nickel lacquered

4. White blown glass

Solitario

Marcello Colli & Maurizio Di Mauro





1. Bronzo spazzolato chiaro opaco
2. Laccato nero seta opaco

3. Sfera vetro acidato $\varnothing 120 / 4.7''$
4. Sfera vetro acidato $\varnothing 200 / 7.9''$
5. Lente flood

1. Matt light satin bronze
2. Matt black silk lacquered

3. Acid-etched glass sphere $\varnothing 120 / 4.7''$
4. Acid-etched glass sphere $\varnothing 200 / 7.9''$
5. Flood lens

Fonte luminosa - Light source

220-240V: PI-So 1 x 7.5W GU10 LED / Ap mini IP44 1 x 7W G9 LED / Ap mini 1 x 10W E27 T8 LED
110V: PI-So 1 x 7.5W GU10 LED / Ap mini IP44 1 x 7W G9 LED / Ap mini 1 x 10W E26 T8 LED

Compatibile con sistemi di controllo remoto in caso di utilizzo di lampadine LED dimmerabili
Compatible with remote control systems when dimmable LED bulbs are used

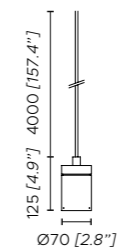
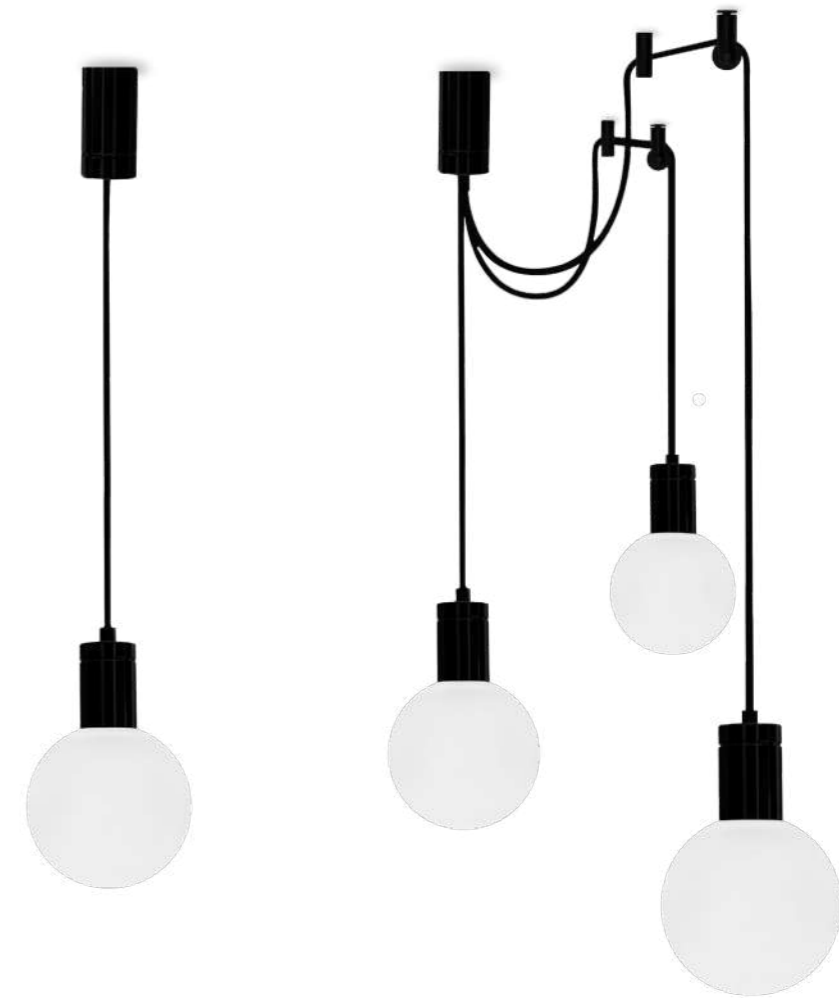



Composizioni / Compositions

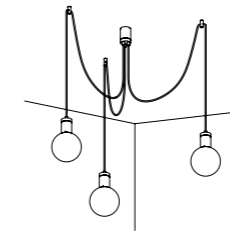

- 1 x Rosone 3x / Canopy 3x
- 3 x Solitario So
- 3 x Kit accessori / Accessories
(Carrucola / Blocca cavo)
(Pulley / Cable clamp)
- 3 x Sfere Ø200 / Spheres Ø200 / Ø7,9"

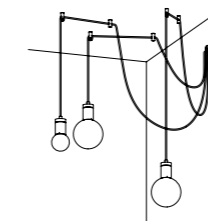

- 1 x Rosone 3x / Canopy 3x
- 3 x Solitario So
- 6 x Kit accessori / Accessories
(Carrucola / Blocca cavo)
(Pulley / Cable clamp)
- 1 x Sfera Ø120 / Sphere Ø120 / Ø4,7"
- 2 x Sfere Ø200 / Spheres Ø200 / Ø7,9"

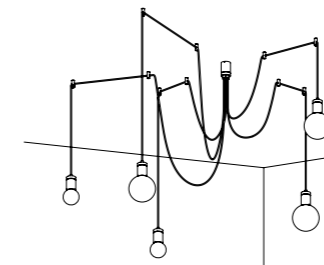

- 1 x Rosone 5x / Canopy 5x
- 5 x Solitario So
- 10 x Kit accessori / Accessories
(Carrucola / Blocca cavo)
(Pulley / Cable clamp)
- 2 x Sfere Ø120 / Spheres Ø120 / Ø4,7"
- 3 x Sfere Ø200 / Spheres Ø200 / Ø7,9"

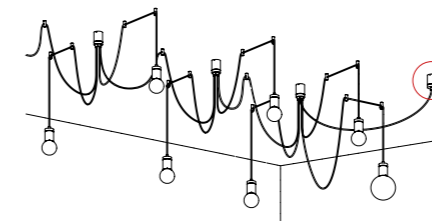

Una sola uscita elettrica per composizioni potenzialmente infinite
Just one electrical output for potentially unlimited compositions

Rosone / Canopy

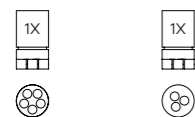

- 1 x rosone 5x / 1 x canopy 5x
- 1 x rosone 3x / 1 x canopy 3x

Sfere / Spheres



- 3 x Ø200 / 4,7"
- 5 x Ø120 / 7,8"

8 x Solitario So

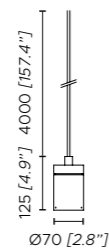

Accessori / Accessories

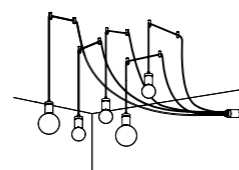
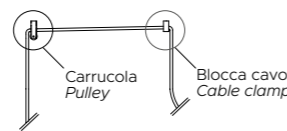

Composizione 5x
Composition 5x

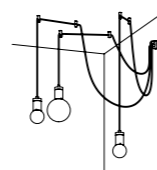

Composizione 3x
Composition 3x

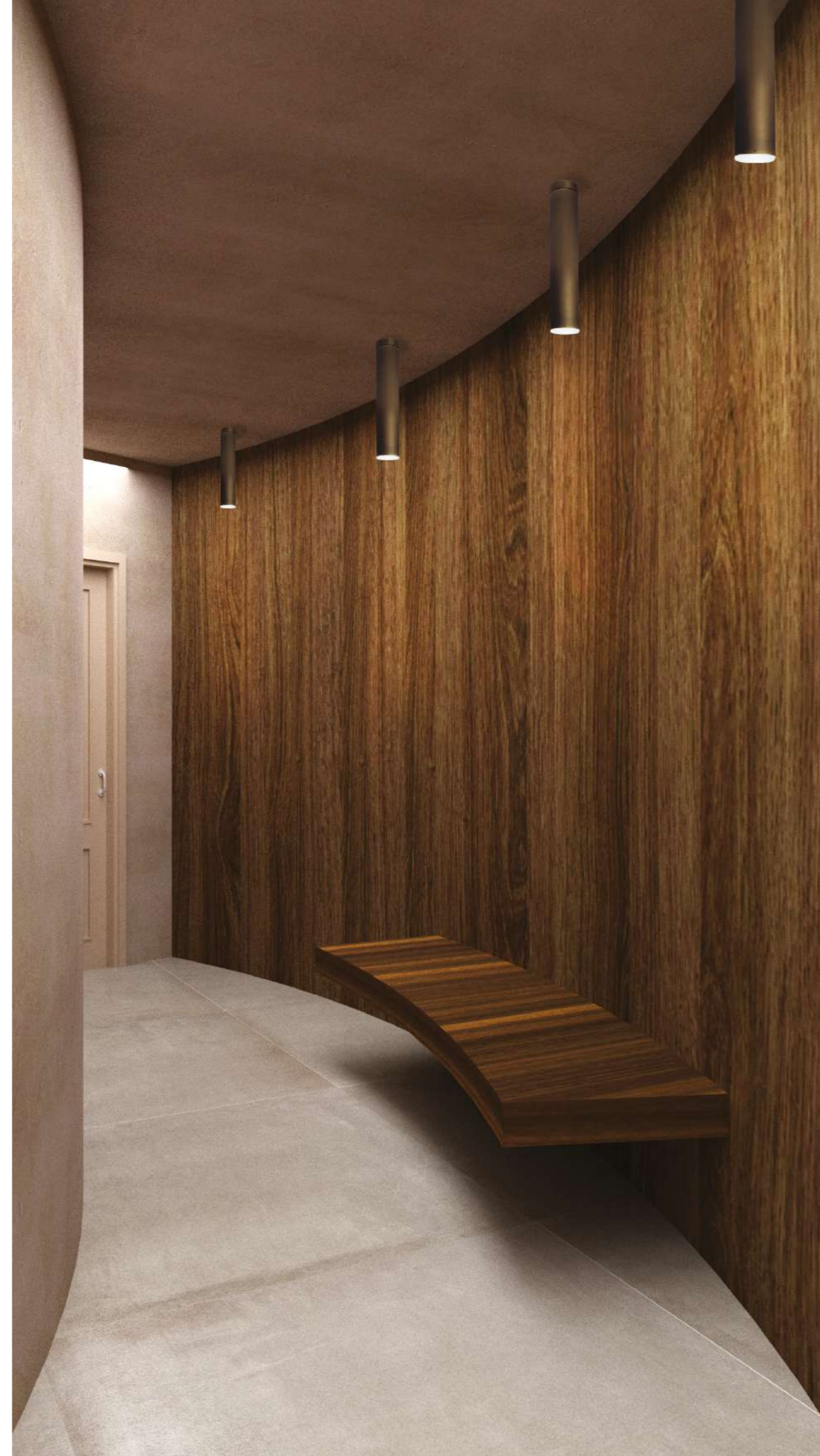
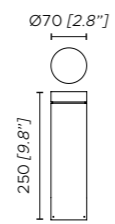
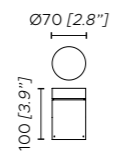

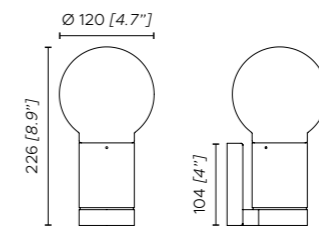

Ap mini / ap mini IP44

Stardust

Marcello Colli & Maurizio Di Mauro





1. Bronzo spazzolato chiaro opaco

2. Vetro bianco satinato

Fonte luminosa - Light source

220-240V: 1 x 14W E27 LED + 20 x 2W LED module
 110V: 1 x 14W E26 LED + 20 x 2W LED module

Fonte luminosa principale compatibile con sistemi di controllo remoto in caso di utilizzo di lampadine LED dimmerabili
 LED module, non dimmerabili
 Main light source compatible with remote control systems when dimmable LED bulbs are used
 LED module, not dimmable

1. Matt light satin bronze

2. Satin white glass

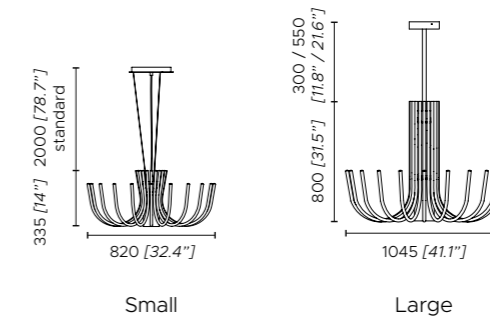

Stick
Studiopepe



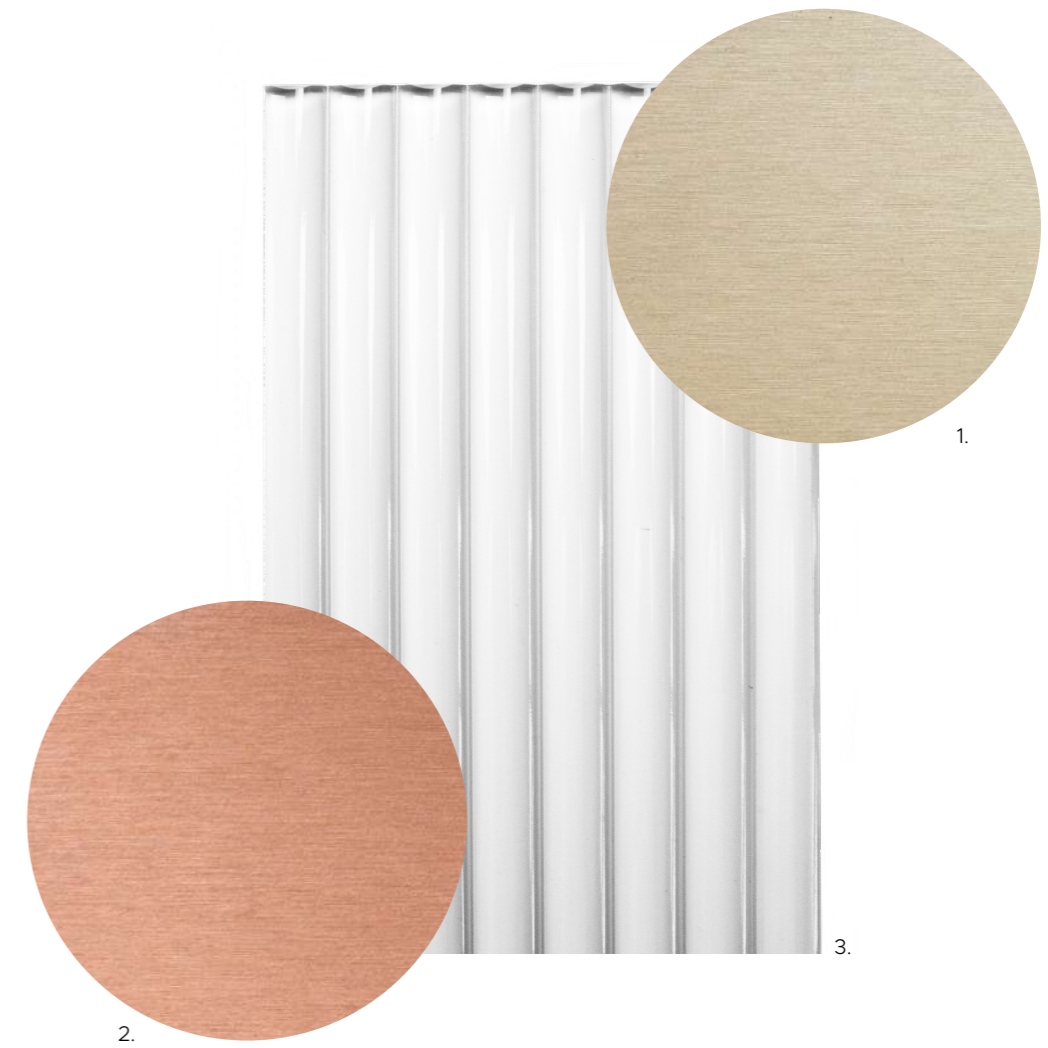
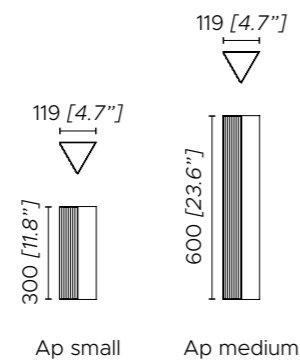

- 1. Finitura nickel dorato satinato
- 2. Finitura rame satinato
- 3. Diffusore rigato

- 1. Satin golden nickel finish
- 2. Satin copper finish
- 3. Ribbed diffuser

ⓘ Altre finiture disponibili su richiesta

ⓘ Other finishes available on demand

Fonte luminosa - Light source

220-240V: Ap small 1 x 13.5W Custom LED / Ap medium 1 x 27W Custom LED
 110V: Ap small 1 x 13.5W Custom LED / Ap medium 1 x 27W Custom LED

*Dimmerabile DALI/Push - DALI/Push dimmable

*Compatibilità con altri sistemi di dimmerazione disponibili su richiesta -
 Compatibility with other dimming systems available on demand

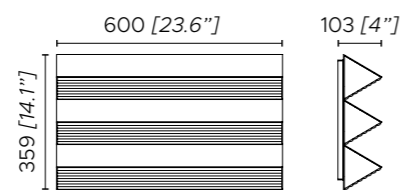

Ap trio



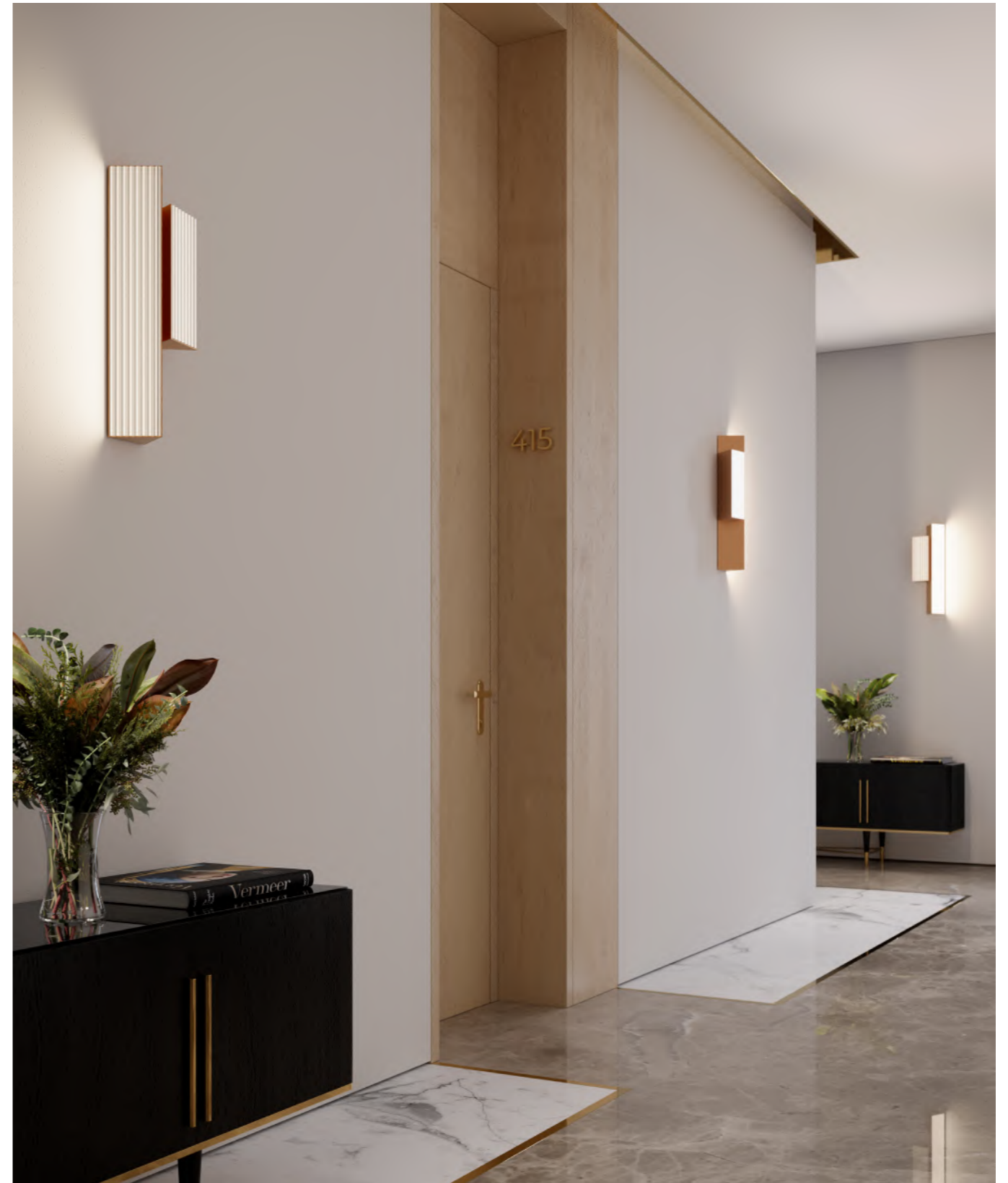
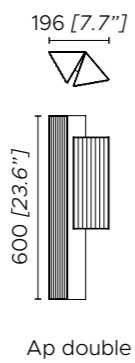

Fonte luminosa - Light source

220-240V: Ap double 1 x 13.5W Custom LED + 1 x 27W Custom LED / Ap trio 3 x 27W Custom LED
 110V: Ap double x 13.5W Custom LED + 1 x 27W Custom LED / Ap trio 3 x 27W Custom LED

*Dimmerabile DALI/Push - DALI/Push dimmable

*Compatibilità con altri sistemi di dimmerazione disponibili su richiesta -
 Compatibility with other dimming systems available on demands

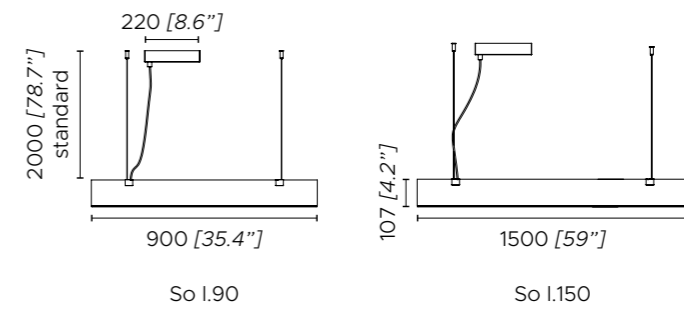

Fonte luminosa - Light source

220-240V: So small 1 x 27W Custom LED / So large 1 x 65W Custom LED
110V: So small 1 x 27W Custom LED / So large 1 x 65W Custom LED

*Dimmerabile DALI/Push - DALI/Push dimmable

*Compatibilità con altri sistemi di dimmerazione disponibili su richiesta -
Compatibility with other dimming systems available on demand

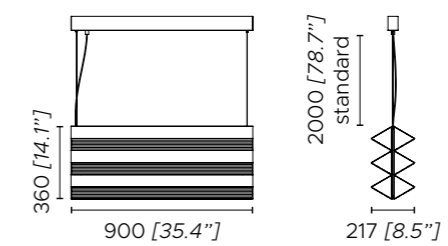

So trio

Fonte luminosa - Light source

220-240V: So trio 1 x 120W Custom LED
 110V: So trio 1 x 120W Custom LED

*Dimmerabile DALI/Push - DALI/Push dimmable

*Compatibilità con altri sistemi di dimmerazione disponibili su richiesta -
 Compatibility with other dimming systems available on demand

Tenebra

Jan Van Lierde





VERSIONE A BATTERIA,
SENZA ROSONE
**BATTERY OPERATED
VERSION, WITHOUT CANOPY**

VERSIONE CABLATA,
CON ROSONE
**WIRED VERSION,
WITH CANOPY**

- 1. Laccato argento
- 2. Laccato oro rosa
- 3. Laccato nero opaco

- 1. Silver lacquered
- 2. Rose gold lacquered
- 3. Matt black lacquered

Fonte luminosa - Light source
220-240V: 1 x 3W LED module - IP65
110V: 1 x 3W LED module - IP65

Battery - dimmerabile / dimmable

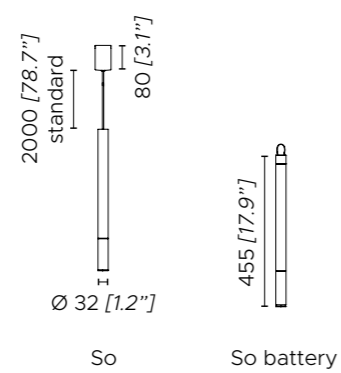

ACCESSORI / ACCESSORIES TENEBRA



1.



2.



3.

- 1. Diffusore cristallo sintetico, Venezia ambra
- 2. Diffusore cristallo sintetico, Lente grigio
- 3. Diffusore cristallo sintetico, Crystal Macedonia

- 1. Diffuser syntethic crystal, Venezia Amber
- 2. Diffuser syntethic crystal, Grey lens
- 3. Diffuser syntethic crystal, Crystal Macedonia



Accessori versione a batteria

ACCESSORI INCLUSI

- 1 x staffa per attacco a soffitti + 1 x griplock + 1 x bloccacavo + 1 x cavo in acciaio l. 2m + 1 x gancio standard

ACCESSORI "A" (non inclusi)

- 1 x cavo in acciaio l. 2m + 1 x gancio design

ACCESSORI "B" (non inclusi)

- 1 x tirante + 2 x bloccacavo + 1 x cavo in acciaio l.10m + 6 x griplock

Battery operated version accessories

INCLUDED ACCESSORIES

- 1 x ceiling attachment + 1 x griplock + 1 x screw lock + 1 x steel cable l. 2m + 1 x standard hook

"A" ACCESSORIES (not included)

- 1 x steel cable l. 2m + 1 x design hook

"B" ACCESSORIES (not included)

- 1 x tie rod + 2 x screw lock + 1 x steel cable l. 10m + 6 x griplock

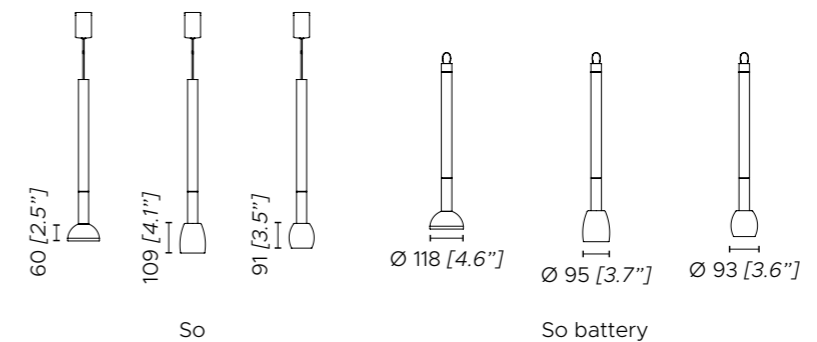



Treasure

Massimiliano Raggi

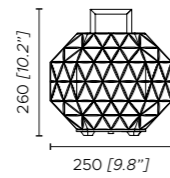

- 1. Nickel lucido
- 2. Cristallo inciso

- 1. Polished nickel
- 2. Engraved crystal

Fonte luminosa - Light source
220-240V: 1 x 10W E27 LED
110V: 1 x 10W E26 LED

Interruttore dimmerabile su cavo
Dimmable switch on the cable

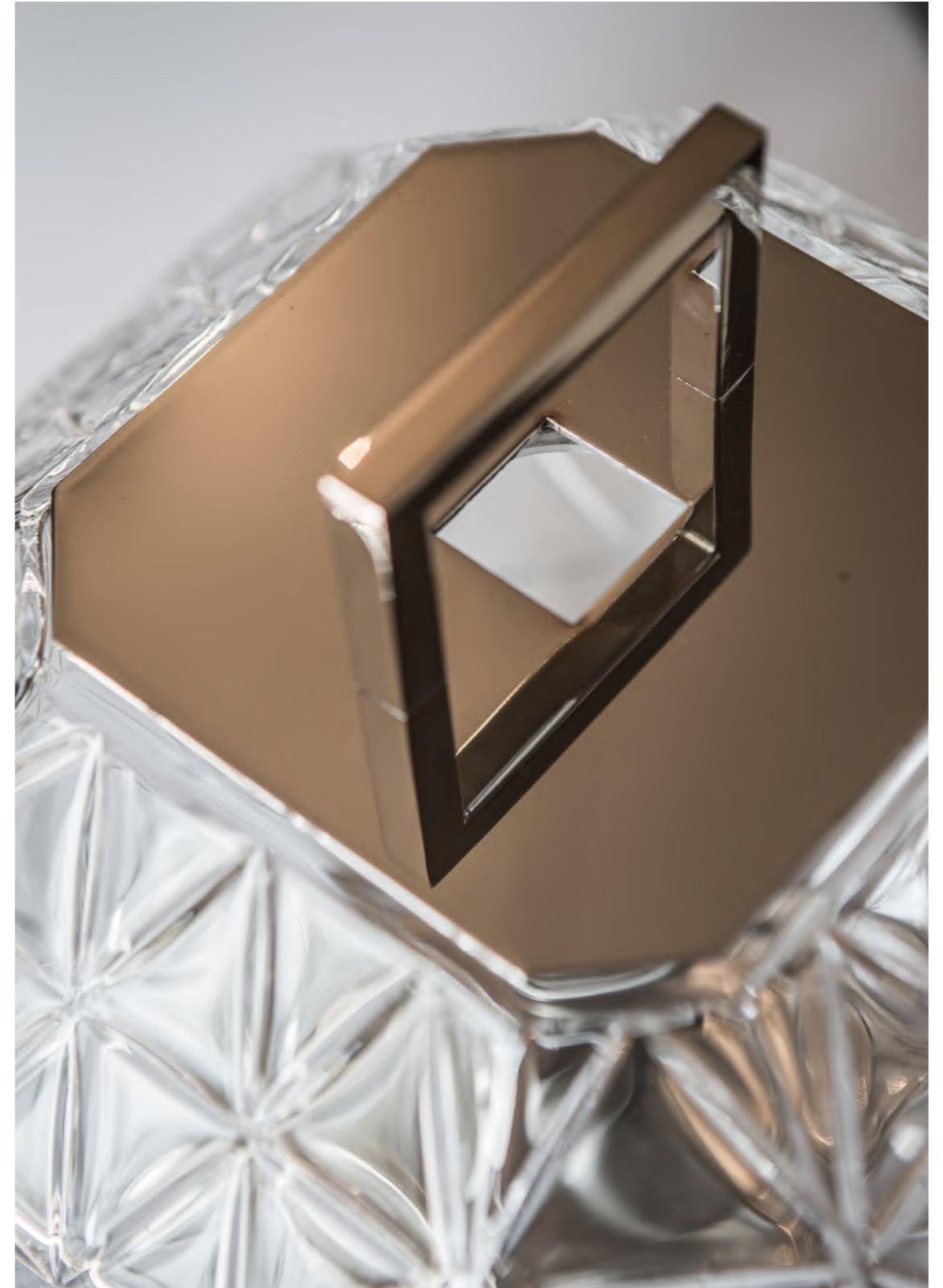

Up

Massimiliano Raggi



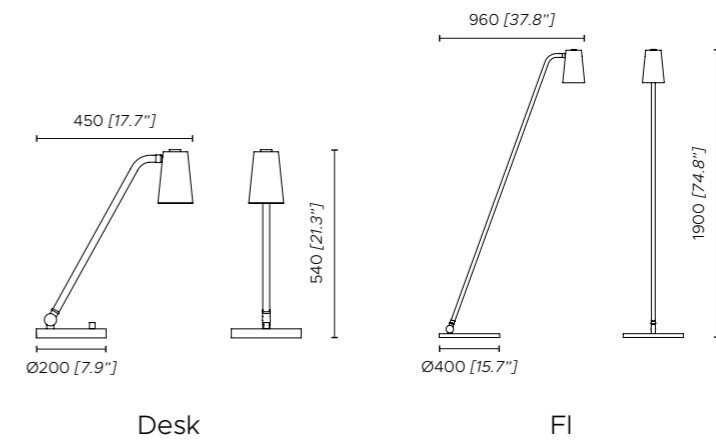

1. Finitura bronzo-nickel spazzolato
2. Cavo in seta color arancione scuro
3. Diffusore esterno: bronzo-nickel spazzolato
4. Diffusore interno: crema lucido

1. Brushed bronze-nickel finish
2. Dark orange silk rope
3. Outside diffuser: brushed bronze-nickel
4. Inside diffuser: polished cream

Fonte luminosa - Light source

220-240V: Ap 1 x 5W E27 LED / Desk 1 x 10W E27 LED / FI 1 x 14W E27 LED
 110V: Ap 1 x 5W E26 LED / Desk 1 x 10W E26 LED / FI 1 x 14W E26 LED

Desk, ap - interruttore rotativo ON-OFF su base / FI - Disponibile su richiesta versione con dimmer a piede, compatibile solo con lampadine LED dimmerabili
 Desk, ap - rotary ON-OFF switch on the base / FI - Foot dimmer available on demand, compatible with dimmable LED light bulbs only

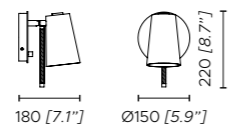

Ap

Vegas
Massimiliano Raggi



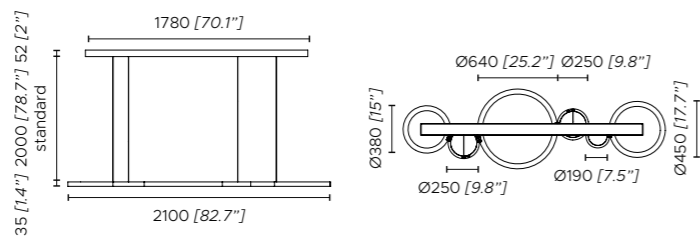

- 1. Rosone bronzo spazzolato
- 2. Anelli grandi in legno bronzo scuro
- 3. Anelli piccoli in legno bronzo chiaro
- 4. Dischi diffusori in alicrite effetto alabastro

- 1. Satin bronze canopy
- 2. Larger rings dark bronze painted wood
- 3. Smaller rings in light bronze painted wood
- 4. Alabaster effect alicrite discs diffusers

Fonte luminosa - Light source

220-240V: 3 x 12W COB LED + 2 x 10W Panel LED + 1 x 8W Panel LED
 110V: 3 x 12W COB LED + 2 x 10W Panel LED + 1 x 8W Panel LED

Dimmerabile DALI/Push - DALI/Push dimmable

*Compatibilità con altri sistemi di dimmerazione disponibili su richiesta -
 Compatibility with other dimming systems available on demand



**Sartoria
Tailoring**

Athena

Massimiliano Raggi



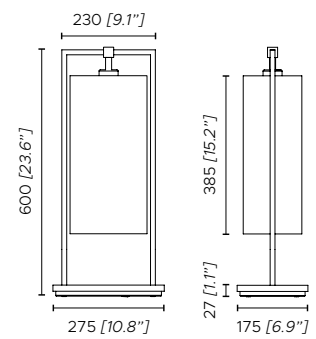

Struttura / Frame



1.



2.

1. Nickel lucido / *Polished nickel*
 2. Rovere tinto marrone scuro / *Dark brown stained oak*

Paralume / Shade

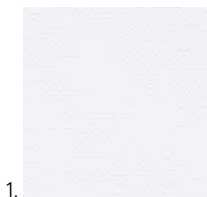

1.



2.

1. Cotone bianco / *White cotton*
 2. Tessuto effetto marmo bianco Calacatta / *White Calacatta marble printed fabric*

Fonte luminosa - Light source

220-240V: 1 x 13W E27 LED
 110V: 1 x 13W E26 LED

Disponibile su richiesta versione con dimmer su cavo, compatibile solo con lampadine LED dimmerabili
 Dimmer switch on the cable available on demand, compatible with dimmable LED light bulbs only

Circus & Circus led

Contardi Studio





Struttura / Frame



Laccato bianco / White lacquered

Paralume / Shade



1.

2.

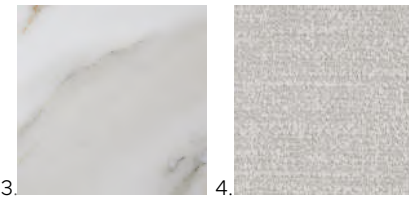

3.

4.

1. Cotone bianco / White cotton

2. Lino bianco / White linen

3. Tessuto effetto marmo bianco Calacatta / White Calacatta marble printed fabric

4. Bouclé color sabbia / Sand colour bouclé

*Altri tessuti sono disponibili su richiesta
Other fabrics available on demand*

Passamaneria opzionale / Optional trim



1.

2.

3.

4.

5.

6.

1. Senape / Mustard

2. Rosso / Red

3. Azzurro / Light blue

1. Blu scuro / Dark blue

2. Grigio / Grey

6. Nero / Black

*Altri colori di passamanerie sono disponibili su richiesta
Other trim colours available on demand*

Fonte luminosa Circus - Circus light source

220-240V: 50-75 3 x 14W E27 LED / 90-120-150 4 x 14W E27 LED

110V: 50-75 3 x 14W E26 LED / 90-120-150 4 x 14W E26 LED

Compatibile con sistemi di controllo remoto in caso di utilizzo di lampadine LED dimmerabili
Compatible with remote control systems when dimmable LED bulbs are used

Fonte luminosa Circus LED - Circus LED light source

220-240V: 50-75 1 x 53W LED custom board / 90-120-150 1 x 70W LED custom board

110V: 50-75 1 x 53W LED custom board / 90-120-150 1 x 70W LED custom board

*Dimmerabile DALI/Push - DALI/Push dimmable

*Compatibilità con altri sistemi di dimmerazione disponibili su richiesta -
Compatibility with other dimming systems available on demand

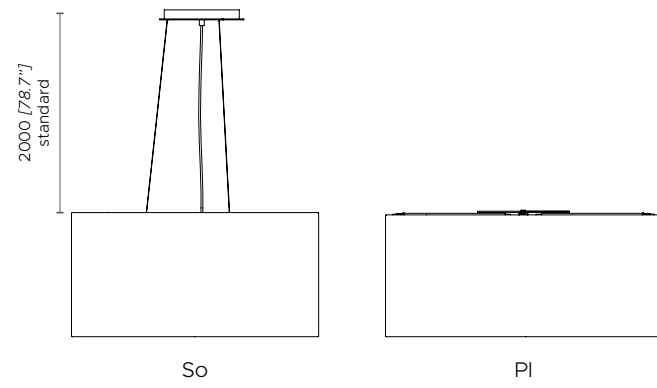

Circus

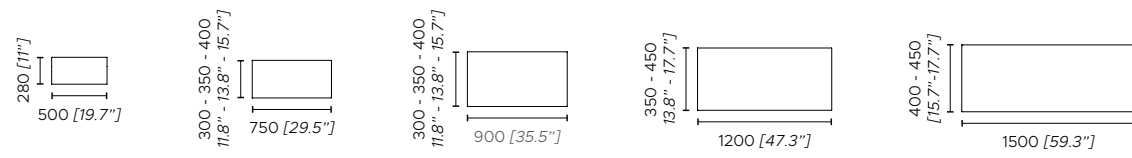

Circus LED

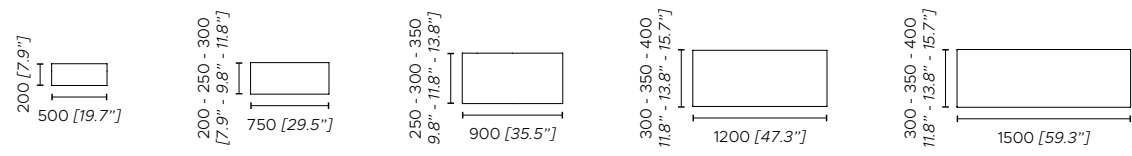

Coco Mega & Deluxe

Coco Mega: Tristan Auer

Coco Deluxe: Tristan Auer & Frédéric Sicard



Struttura / Frame

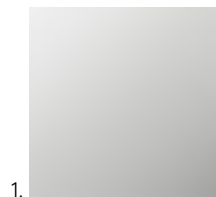

1. Nickel lucido / Polished nickel

Paralume / Shade

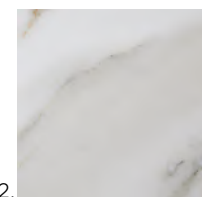
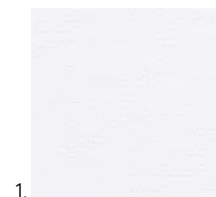

1. Cotone bianco / White cotton
2. Tessuto effetto marmo bianco Calacatta / White Calacatta marble printed fabric

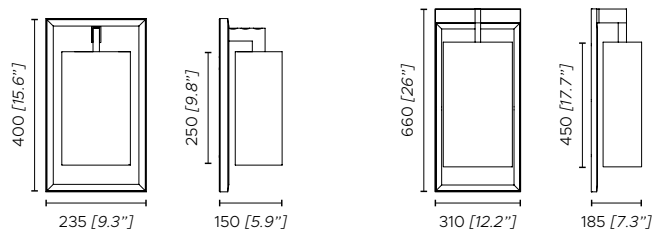

Coco Deluxe Ap

Coco Mega Ap



Fonte luminosa - Light source

220-240V: Mega ap, ta 1 x 14W E27 LED / Deluxe ap, ta 1 x 10W E27 LED
110V: Mega ap, ta 1 x 14W E26 LED / Deluxe ap, ta 1 x 10W E26 LED

Mega ap, Deluxe ap - compatibile con sistemi di controllo remoto in caso di utilizzo di lampadine LED dimmerabili
Mega ta, Deluxe ta - disponibile su richiesta versione con dimmer su cavo, compatibile solo con lampadine LED dimmerabili
Mega ap, Deluxe ap - compatible with remote control systems when dimmable LED bulbs are used
Mega ta, Deluxe ta - dimmer switch on the cable available on demand, compatible with dimmable LED light bulbs only

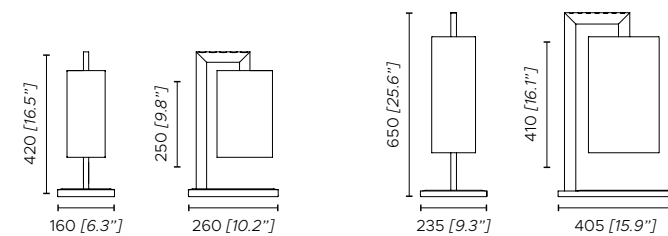

Coco Deluxe Ta

Coco Mega Ta



Coco & Coconette

Tristan Auer & Frédéric Sicard

Struttura / Frame

1.

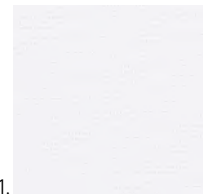

2.

Coco - Coco Mini IP441. Nickel lucido / *Polished nickel***Coconette**2. Bronzo spazzolato chiaro opaco / *Matt light satin bronze***Paralume / Shade**

1.

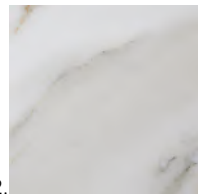

2.

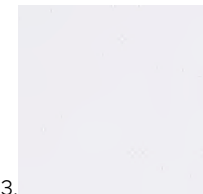

3.

Coco Ap - Coconette Ap1. Cotone bianco / *White cotton*2. Tessuto effetto marmo bianco Calacatta /
*White Calacatta marble printed fabric***Coco Ap Mini IP44**3. Tessuto impermeabile bianco / *Waterproof white fabric***Fonte luminosa - Light source**

220-240V: Coco & Coconette 1 x 10W E27 LED - Coco mini IP44 1 x 9W G9 LED

110V: Coco & Coconette 1 x 10W E26 LED - Coco mini IP44 1 x 9W G9 LED

Compatibile con sistemi di controllo remoto in caso di utilizzo di lampadine LED dimmerabili
Compatible with remote control systems when dimmable LED bulbs are used



Coconette



Coco

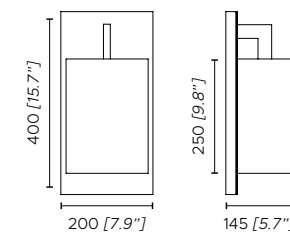

Coconette

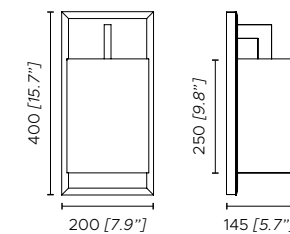

Coco

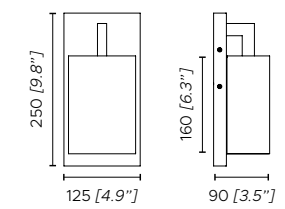
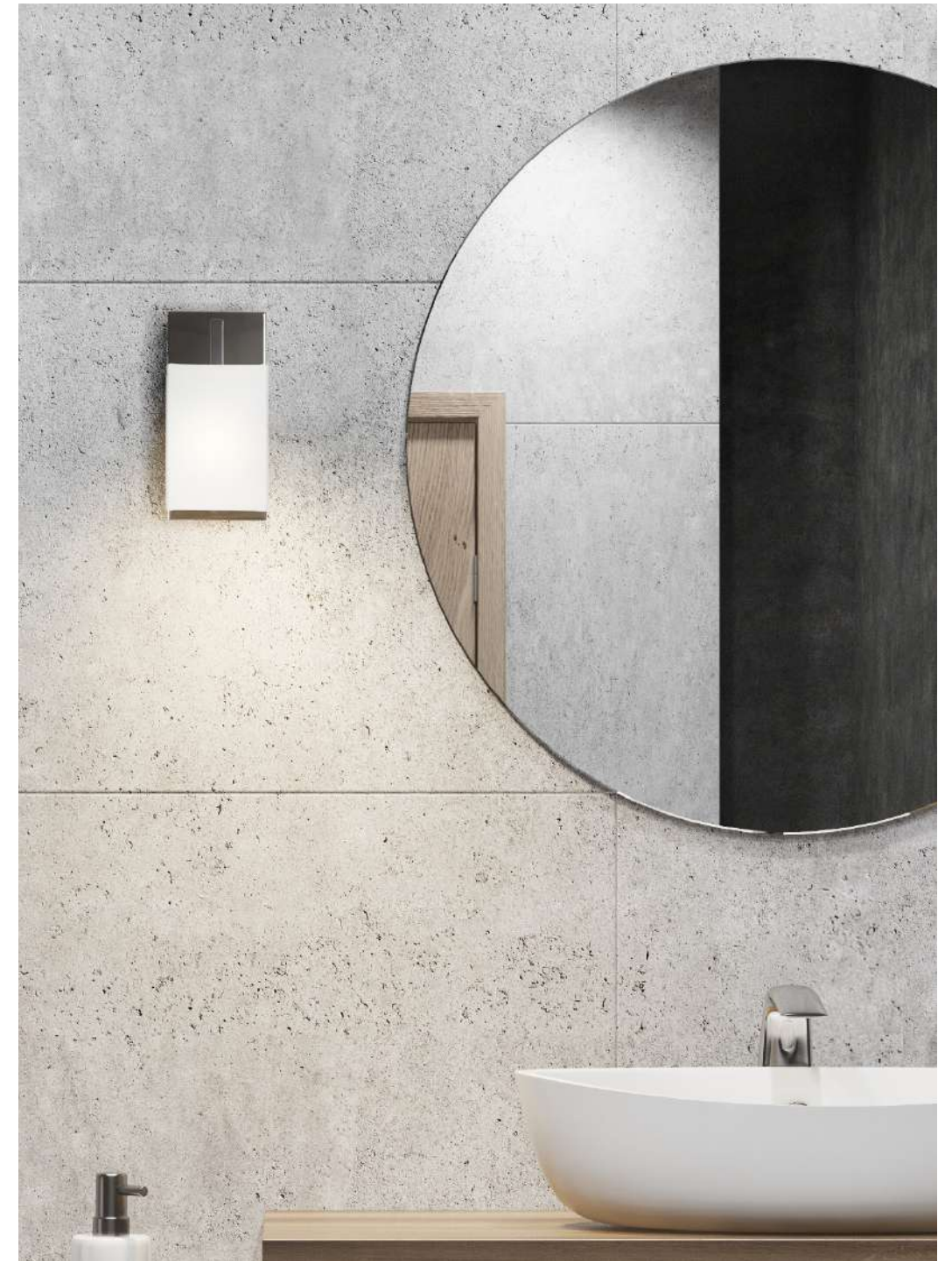

Coco mini IP44



Ovale

Contardi Studio

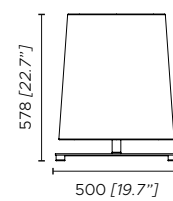

Ta



Ta small



Struttura / Frame

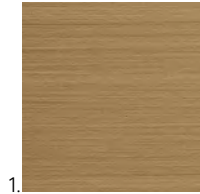

1.



2.

1. Bronzo spazzolato chiaro opaco / *Matt light satin bronze*
 2. Laccato nero seta opaco / *Matt black silk lacquered*

Paralume / Shade

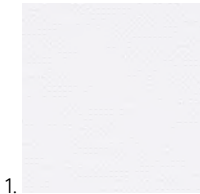

1.

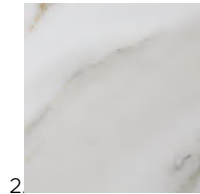

2.

1. Cotone bianco / *White cotton*
 2. Tessuto effetto marmo bianco Calacatta / *White Calacatta marble printed fabric*

 *Passamanerie disponibili su richiesta*
Trims available on demand

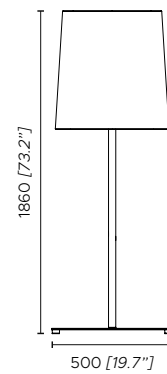

FI

Fonte luminosa - Light source

220-240V: ta small 1 x 10W E27 LED / ta 1 x 13W E27 LED / fl 1 x 14W E27 LED
 110V: ta small 1 x 10W E26 LED / ta 1 x 13W E26 LED / fl 1 x 14W E26 LED

Disponibile su richiesta versione con dimmer su cavo, compatibile solo con lampadine LED dimmerabili
 Dimmer switch on the cable available on demand, compatible with dimmable LED light bulbs only





Ap

Ap led

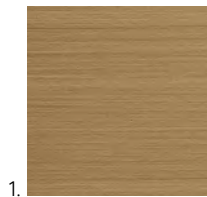
Struttura / Frame

1.

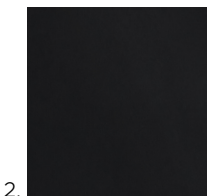

2.

1. Bronzo spazzolato chiaro opaco / *Matt light satin bronze*
 2. Laccato nero seta opaco / *Matt black silk lacquered*

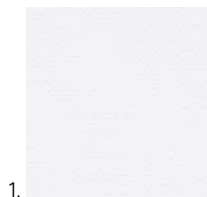
Paralume / Shade

1.

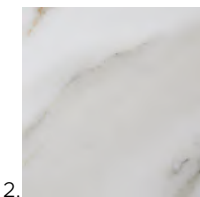

2.

1. Cotone bianco / *White cotton*
 2. Tessuto effetto marmo bianco Calacatta / *White Calacatta marble printed fabric*

 *Passamanerie disponibili su richiesta*
Trims available on demand

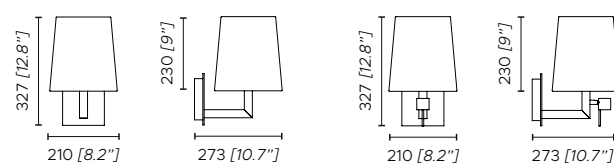

Ap

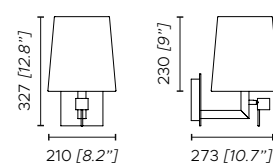

Ap led

Fonte luminosa - Light source

220-240V: Ap, ta 1 x 10W E27 LED / Ap LED 1 x 10W E27 LED + 1 x 3W LED module / Ta desk 1 x 12W E27 LED / FI, liseuse 1 x 14W E27 LED
 110V: Ap, ta 1 x 10W E26 LED / Ap LED 1 x 10W E26 LED + 1 x 3W LED module / Ta desk 1 x 12W E26 LED / FI, liseuse 1 x 14W E26 LED

Ap - compatibile con sistemi di controllo remoto in caso di utilizzo di lampadine LED dimmerabili

Ta, ta desk, fi, liseuse - disponibile su richiesta versione con dimmer su cavo, compatibile solo con lampadine LED dimmerabili

Ap - compatible with remote control systems when dimmable LED bulbs are used

Ta, ta desk, fi, liseuse - dimmer switch on the cable available on demand, compatible with dimmable LED light bulbs only

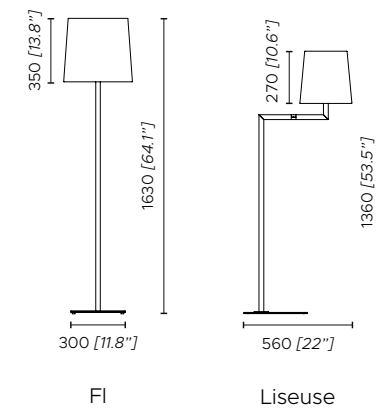
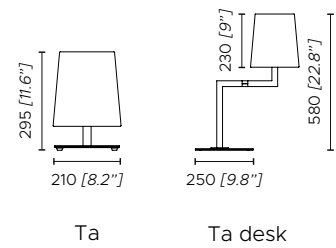
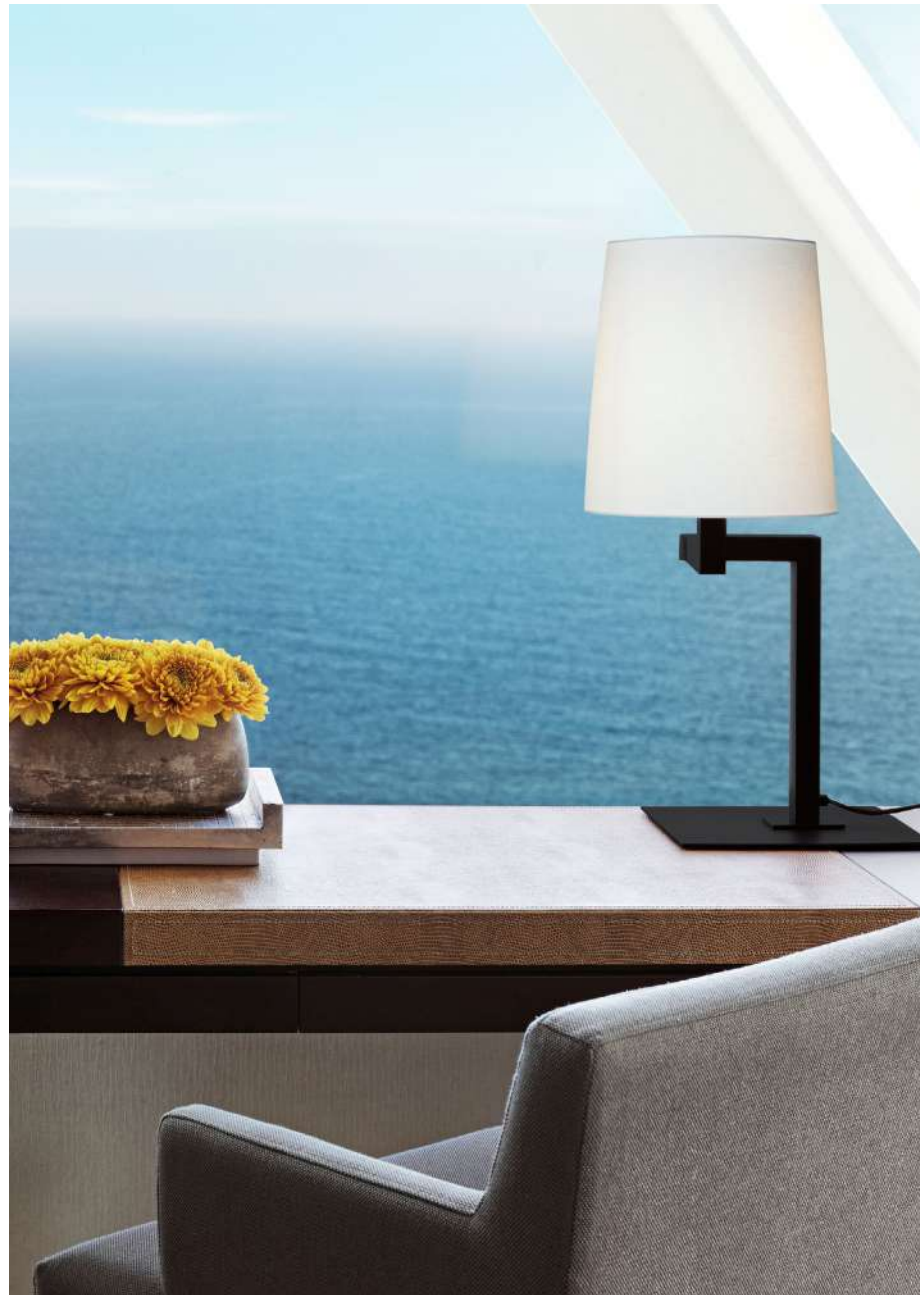

 **contardi**

outdoor



BLENDING
TECHNOLOGY
& CREATIVE
DESIGN



1. Lo stile incontra la sostanza *Timeless design created in Italy*

La nostra Collezione Outdoor è un chiaro esempio di questa combinazione ideale: un modo per portare all'esterno il mondo indoor, mantenendo le stesse caratteristiche decorative e di qualità del prodotto per interni, senza dimenticare l'aspetto pragmatico relativo alla destinazione d'uso. L'utilizzo di materiali e tessuti decorativi di alta qualità è combinato con finiture e caratteristiche richieste dai più alti standard, tra cui la certificazione IP65 e il trattamento di cataforesi "Marine Grade".

We at Contardi interpret the outdoor collection as a way to bring the interior design to the open-air. The idea is to keep the same decorative and qualitative characteristics of the indoor products without forgetting the pragmatic aspect, specifically the intended use. The use of high-quality decorative materials and fabrics is successfully combined with finishes and regulations required for the highest standards, such as the IP65 and the "Marine Grade".

B

6 **BABU**

C

14 **CALYBABU**
18 **CALYPSO OUTDOOR** so, fl
34 **COCO OUTDOOR**
38 **CUBE OUTDOOR** wired, battery

F

44 **FREEDOM** wired, battery

L

50 **LAGOON**

M

56 **MUSE LANTERN OUTDOOR** so, wired, battery
64 **MUSE OUTDOOR** so, wired, battery

T

72 **TENEBRA** wired, battery

Lampada a parete
Wall lamp

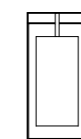

Coco Outdoor
34



Freedom
44

Lampada a sospensione
Suspension lamp



Calypso Outdoor
18



Muse Lantern Outdoor
56



Muse Outdoor
64



Tenebra
72

Lampada da terra & pouf
Floor lamp & pouf



Babu
6



Calypso Outdoor
18



Cube Outdoor
38



Freedom
44

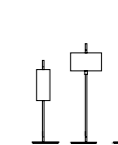

Lagoon
50



Muse Lantern Outdoor
56



Muse Outdoor
64



Calybabu
14

Lampada da tavolo
Table lamp



Freedom
44



Muse Lantern Outdoor
56



Muse Outdoor
64

Lampada a batteria
Battery lamp



Cube Outdoor
38



Freedom
44



Muse Lantern Outdoor
56



Muse Outdoor
64



Tenebra
72

Babu

Massimiliano Raggi



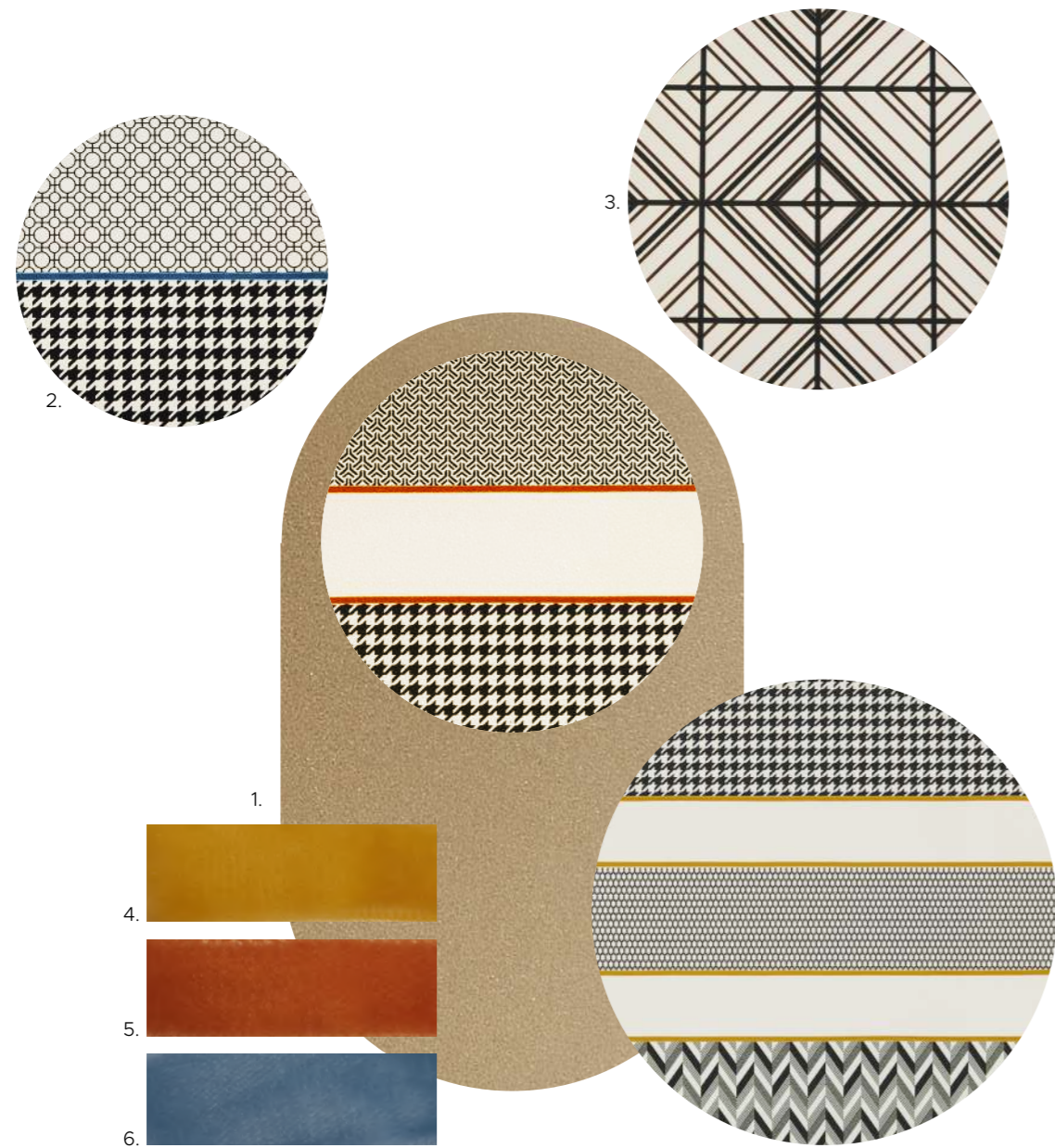

1. Acciaio laccato effetto champagne, trattamento cataforesi Marine Grade

2. Stampa Textile digitale 3D su tessuto
3. Stampa Tribal digitale 3D su tessuto

4. Passamaneria in velluto outdoor senape
5. Passamaneria in velluto outdoor arancio
6. Passamaneria in velluto outdoor blu avio

① *Stampa digitale 3D su tessuto personalizzabile su richiesta*

1. Champagne lacquered steel, Marine Grade with cataphoresis treatment

2. 3D digital Textile printing on fabric
3. 3D digital Tribal printing on fabric

4. Mustard colour velvet trim for outdoor use
5. Orange colour velvet trim for outdoor use
6. Aviation blue colour velvet trim for outdoor use

① *3D digital printing fabric customizable fabric on demand*

Fonte luminosa - Light source
220-240V: Strip LED 1 x 17/24/34 W
110V: Strip LED 1 x 17/24/34 W

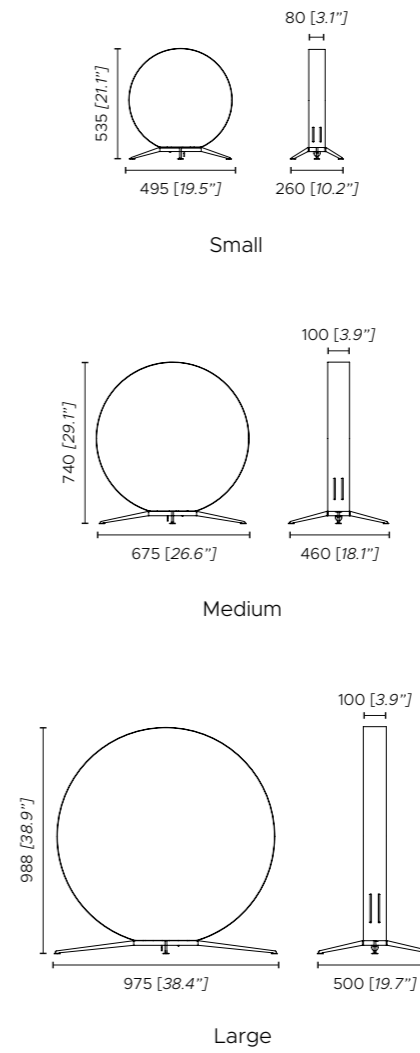



STAMPA 3D **TEXTILE & TRIBAL**
3D PRINT **TEXTILE & TRIBAL**



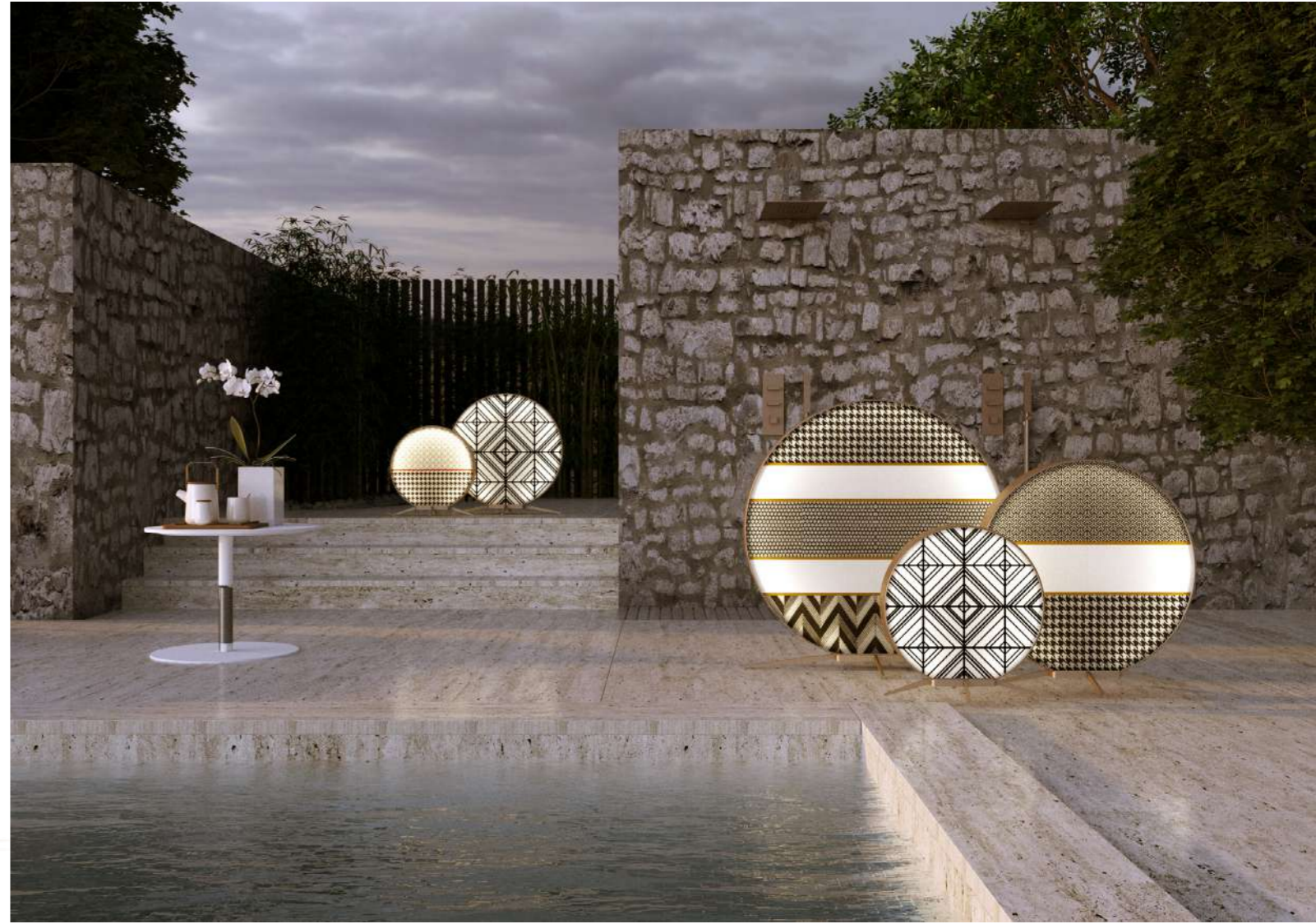
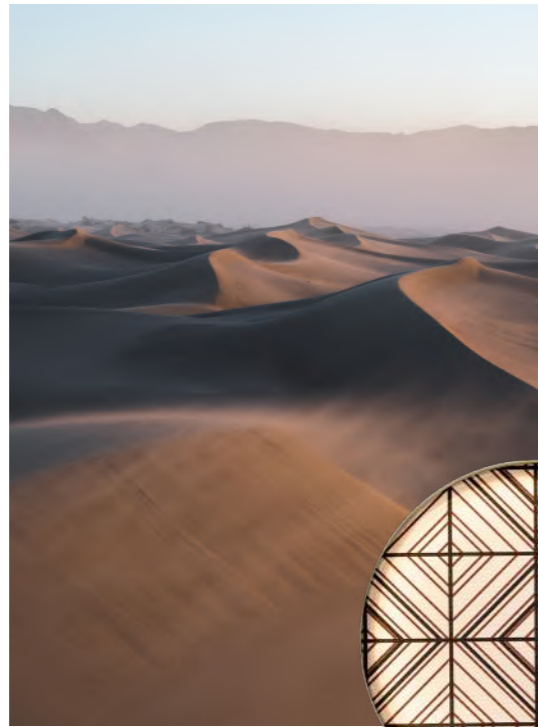

Calybabu

Massimiliano Raggi



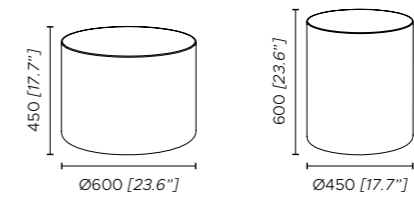

1. Pattern H
 2. Pattern I
 3. Pattern L

4. Pattern M
 5. Pattern N

Calypso outdoor

Servomuto





- 1. Ottone satinato
- 2. Corda da marina impermeabile intrecciata in tinta verde
- 3. **Paralume SO**: Antigua, Guadaloupe, Martinique
- 4. Diffusore vetro trasparente

- 1. Satin brass
- 2. Green waterproof braided rope
- 3. **SO shade**: Antigua, Guadaloupe, Martinique
- 4. Transparent glass diffuser

Fonte luminosa - Light source
 220-240V: 1 x 9W E27 T8 Tubular LED
 110V: 1 x 9W E26 T8 Tubular LED

Compatibile con sistemi di controllo remoto in caso di utilizzo di lampadine LED dimmerabili
 Compatible with remote control systems when dimmable LED bulbs are used

CALYPSO SO



Antigua
Mint



Guadeloupe
Mint



Martinique
Yellow



Antigua
Black



Guadeloupe
Black



Martinique
Black



Antigua
Sale & Pepe



Guadeloupe
Sale & Pepe



Martinique
Building

1900 [74.8"] 95 [3.7"]
standard

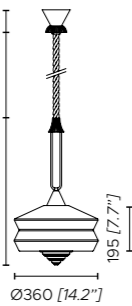

Antigua

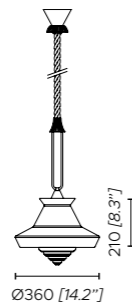

Guadeloupe

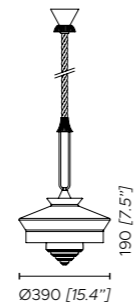

Martinique





CALYPSO SO XL



Antigua
Mint



Guadaloupe
Sale & Pepe



Martinique
Yellow

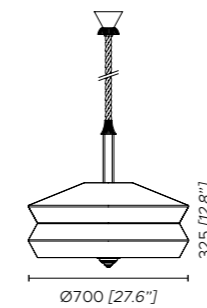

Antigua

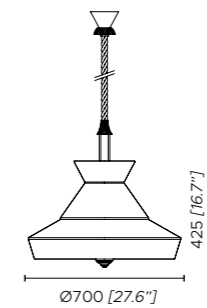

Guadaloupe

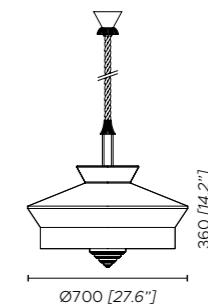

Martinique

Fonte luminosa - Light source
220-240V: 1 x 9W E27 T8 Tubular LED
110V: 1 x 9W E26 T8 Tubular LED

Compatibile con sistemi di controllo remoto in caso di utilizzo di lampadine LED dimmerabili
Compatible with remote control systems when dimmable LED bulbs are used



CALYPSO
**FLOOR
OUTDOOR**

Servomuto



GEOMETRIC
PATTERNS
& BRIGHT
COLOURS

TRAME GEOMETRICHE & COLORI BRILLANTI

Fl Single

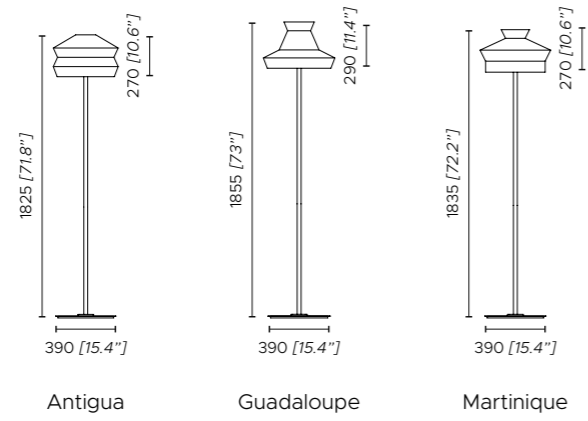

Fl+Table

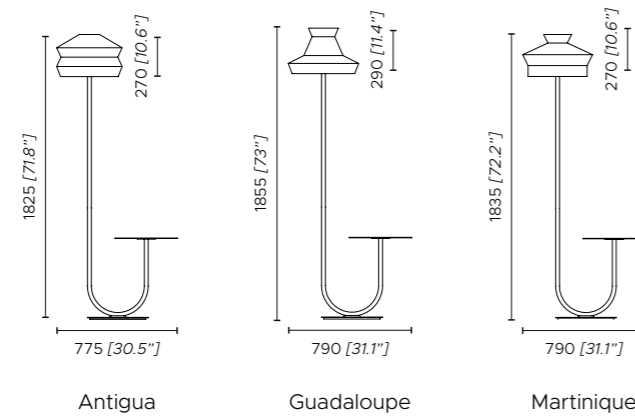

- 1. Laccato nero opaco
- 2. Laccato verde reseda

- 1. Matt black lacquered
- 2. Reseda green lacquered

3. **Paralume FL:** Antigua, Guadeloupe, Martinique

3. **FL shade:** Antigua, Guadeloupe, Martinique

Fonte luminosa - Light source
 220-240V: 1 x 9W E27 T8 Tubular LED
 110V: 1 x 9W E26 T8 Tubular LED

Compatibile con sistemi di controllo remoto in caso di utilizzo di lampadine LED dimmerabili
 Compatible with remote control systems when dimmable LED bulbs are used



Coco outdoor

Tristan Auer



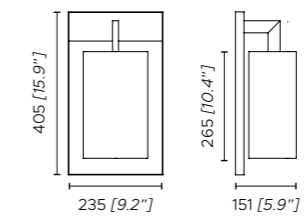

Small

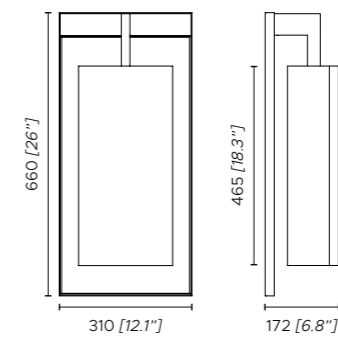

Mega

1. Acciaio spazzolato

2. Legno marino in moca scuro con trattamento impermeabilizzante

3. Tessuto impermeabile Sale & Pepe

1. Satin steel

2. Dark mocha marine wood with waterproof treatment

3. Sale & Pepe waterproof fabric

Fonte luminosa - Light source

220-240V: Small 1 x 10W E27 LED / Mega 1 x 14W E27 LED

110V: Small 1 x 10W E26 LED / Mega 1 x 14W E26 LED

Compatibile con sistemi di controllo remoto in caso di utilizzo di lampadine LED dimmerabili
Compatible with remote control systems when dimmable LED bulbs are used

Cube outdoor

Massimiliano Raggi





- 1. Esterno: bronzo scuro
- 2. Interno: laccato oro, trattamento cataforesi Marine Grade
- 3. Laccato bianco opaco, trattamento cataforesi Marine Grade
- 4. Diffusore plexiglass rigato

- 1. Outside: dark bronze
- 2. Inside: gold lacquered, Marine Grade with cataphoresis treatment
- 3. Matt white lacquered, Marine Grade with cataphoresis treatment
- 4. Striped plexiglass diffuser

Fonte luminosa - Light source

220-240V: Wired version 1 x 10W E27 LED / Battery version 1 x 4W LED module
 110V: Wired version 1 x 10W E26 LED / Battery version 1 x 4W LED module

Versione cablata: compatibile con sistemi di controllo remoto in caso di utilizzo di lampadine LED dimmerabili
 Wired version: compatible with remote control systems when dimmable LED bulbs are used

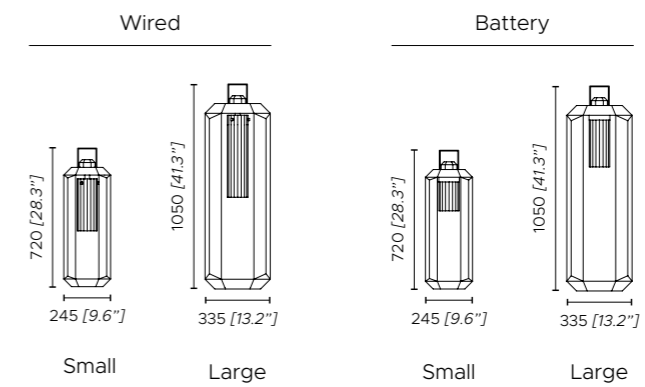



VERSIONE A **BATTERIA**
BATTERY OPERATED VERSION



ACCENSIONE / SPEGNIMENTO
ON/OFF SWITCHING

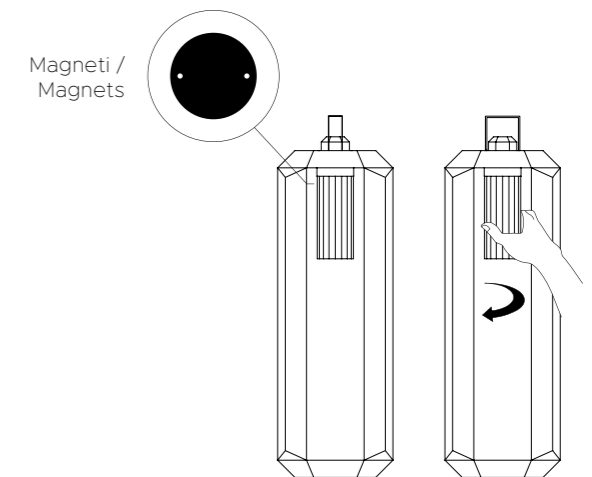

Freedom

Massimiliano Raggi



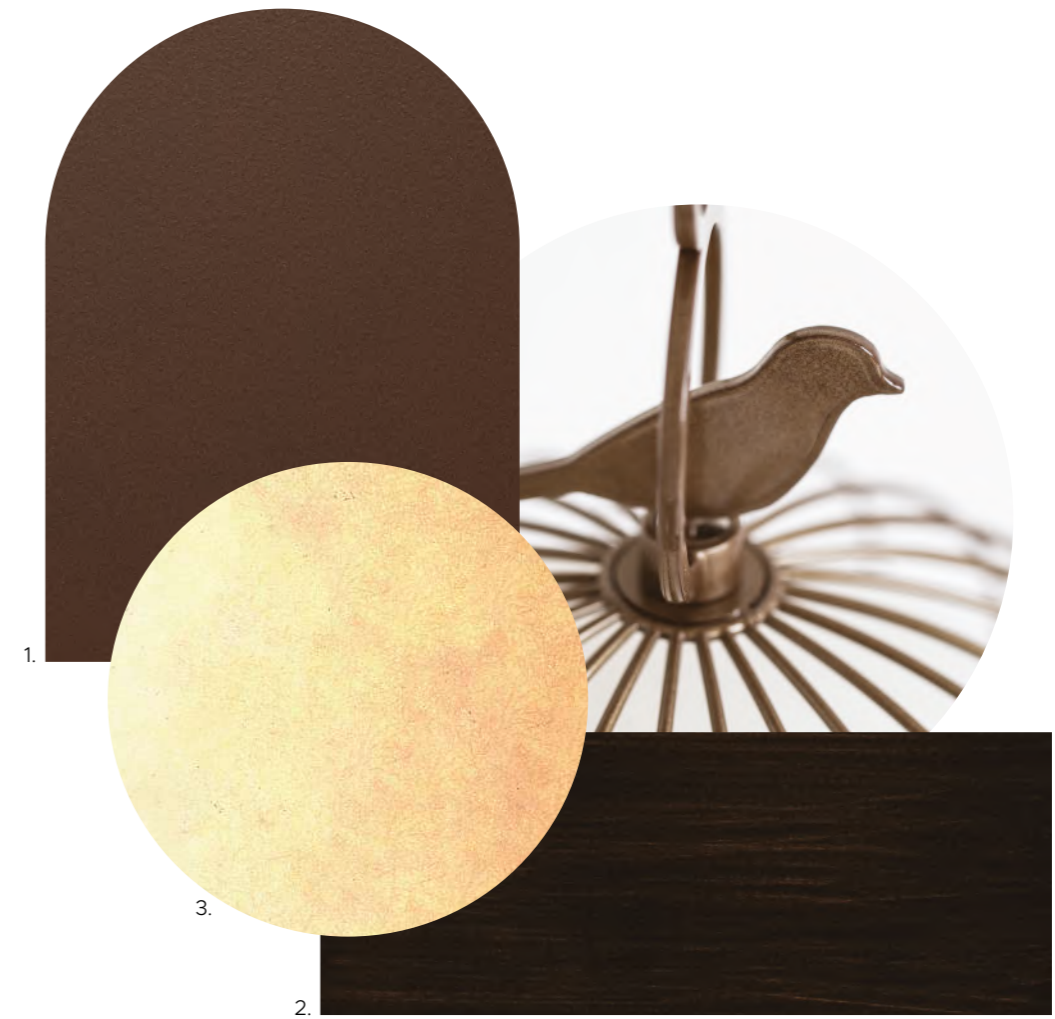

1. Gabbia in metallo verniciato bronzo
2. Base in legno marino marrone scuro
con trattamento cataforesi

3. Diffusore vetroresina crema

1. Cage in bronze lacquered metal
2. Dark brown marine wood with waterproof
treatment for the base

3. Cream-coloured fiberglass diffuser

Fonte luminosa - Light source

220-240V: Wired version 1 x 10W E27 LED / Battery version 1 x 3W LED module
110V: Wired version 1 x 10W E26 LED / Battery version 1 x 3W LED module

Versione cablata: compatibile con sistemi di controllo remoto in caso di utilizzo di lampadine LED dimmerabili
Wired version: compatible with remote control systems when dimmable LED bulbs are used





ACCESSORI / ACCESSORIES FREEDOM BATTERY



Gancio da parete
Hook for wall

Gancio per piantana
Hook for floor

Piastra da terra
Ground plate

Lagoon

Servomuto



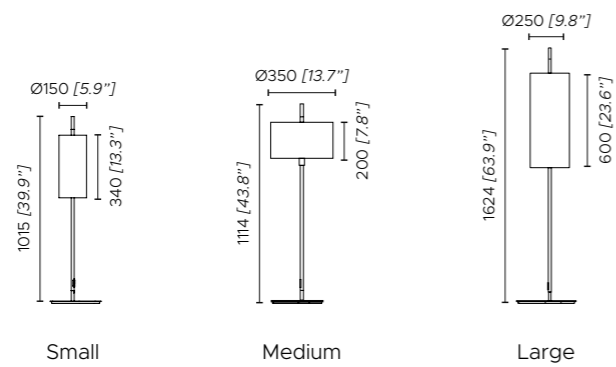

- 1. Laccato nero opaco
- 2. Laccato rame
- 3. Paralume Noumea Goyave (Pierre Frey)
- 4. Paralume Dominica Caraibes (Pierre Frey)
- 5. Paralume Bayamo Mimosa (Pierre Frey)

- 1. Matt black lacquered
- 2. Copper lacquered
- 3. Noumea Goyave shade (Pierre Frey)
- 4. Dominica Caraibes shade (Pierre Frey)
- 5. Bayamo Mimosa shade (Pierre Frey)

Fonte luminosa - Light source
 220-240V: 1 x 9W E27 T8 Tubular LED
 110V: 1 x 9W E26 T8 Tubular LED

Compatibile con sistemi di controllo remoto in caso di utilizzo di lampadine LED dimmerabili
 Compatible with remote control systems when dimmable LED bulbs are used



VERSIONE A PICCHETTO
PICKET VERSION

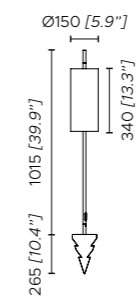

Small

Muse lantern outdoor

Tristan Auer



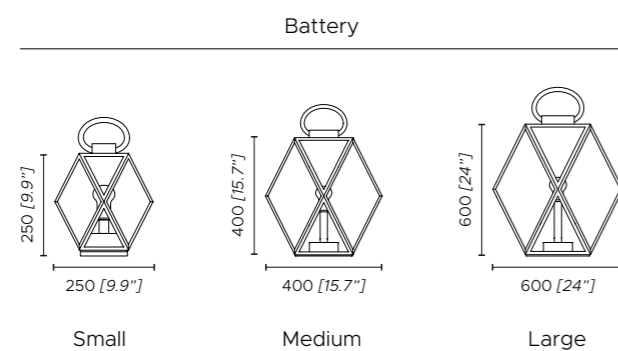

- 1. Laccato bronzo trattamento cataforesi Marine Grade
- 2. Maniglia in cuoio intrecciata marrone
- 3. Diffusore acrilico color ambra

- 1. Bronze lacquered Marine Grade with cataphoresis treatment
- 2. Brown braided leather handle
- 3. Amber acrylic diffuser

Fonte luminosa - Light source

220-240V: So - Wired version 1 x 10W E27 LED / Battery version 1 x 3W LED module
 110V: So - Wired version 1 x 10W E26 LED / Battery version 1 x 3W LED module

Versione cablata: compatibile con sistemi di controllo remoto in caso di utilizzo di lampadine LED dimmerabili
 Wired version: compatible with remote control systems when dimmable LED bulbs are used

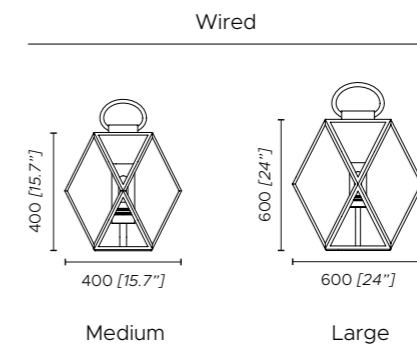
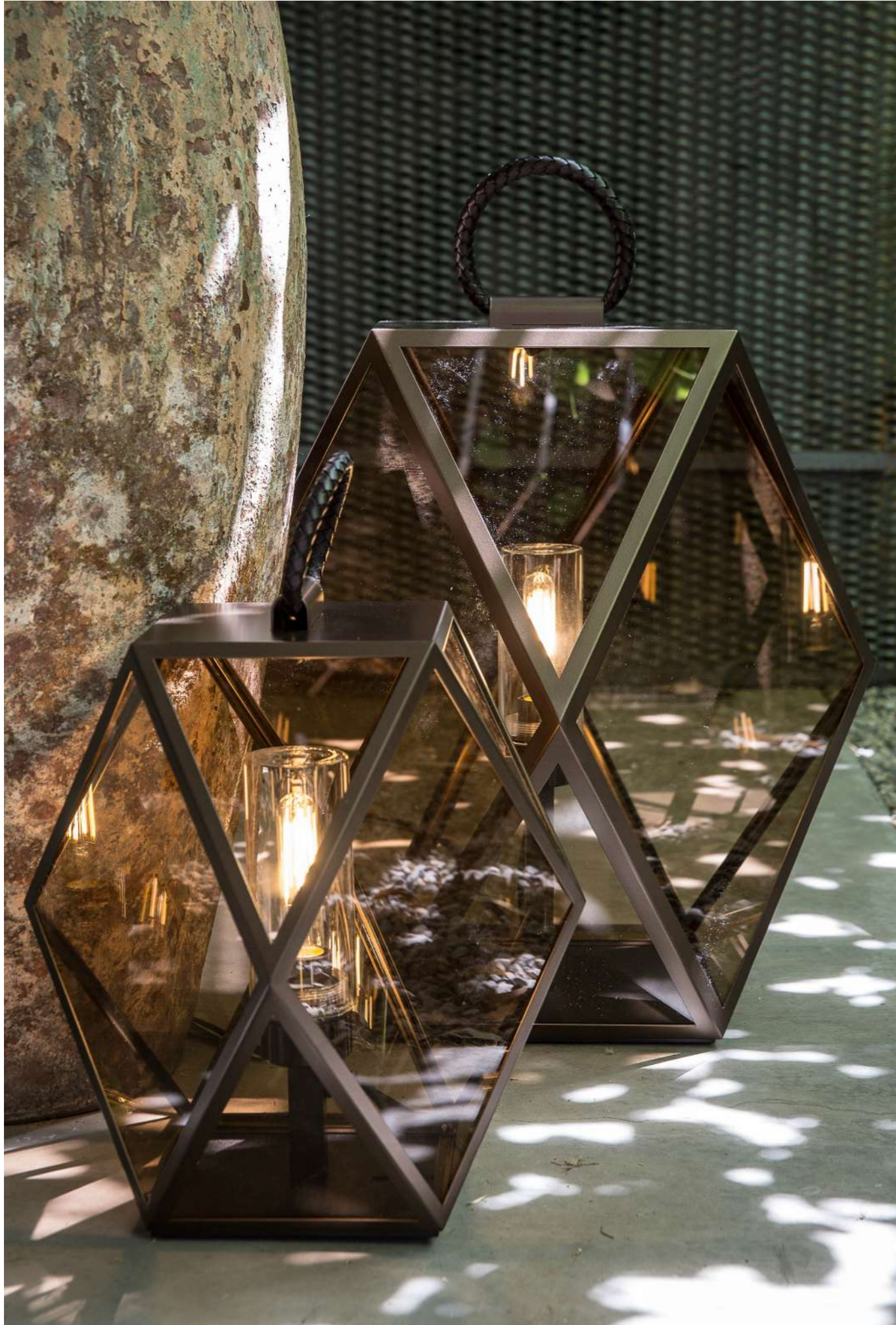

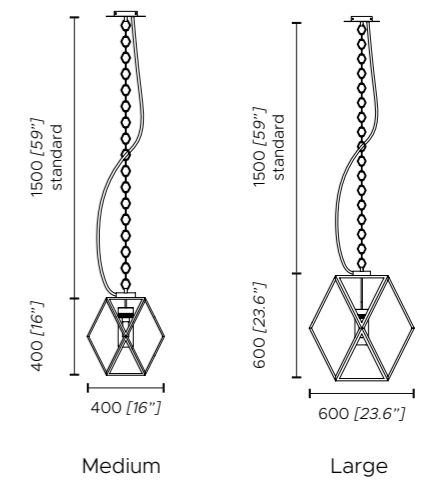

Muse outdoor

Tristan Auer



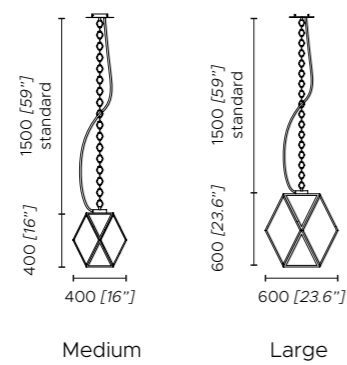

1. Laccato bianco opaco
Trattamento cataforesi Marine Grade

2. Laccato nero opaco
Trattamento cataforesi Marine Grade

3. Maniglia in cuoio intrecciato bianco/nero

4. Diffusore acrilico satinato

1. Matt white lacquered
Marine Grade with cataphoresis treatment

2. Matt black lacquered
Marine Grade with cataphoresis treatment

3. White/black braided leather handle

4. Satin acrylic diffuser

Fonte luminosa - Light source

220-240V: So - Wired version 1 x 10W E27 LED / Battery version 1 x 3W LED module
110V: So - Wired version 1 x 10W E26 LED / Battery version 1 x 3W LED module

Versione cablata: compatibile con sistemi di controllo remoto in caso di utilizzo di lampadine LED dimmerabili
Wired version: compatible with remote control systems when dimmable LED bulbs are used



Wired

Battery

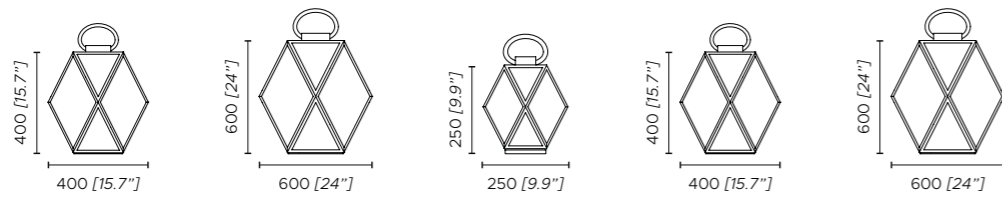



Tenebra

Jan Van Lierde



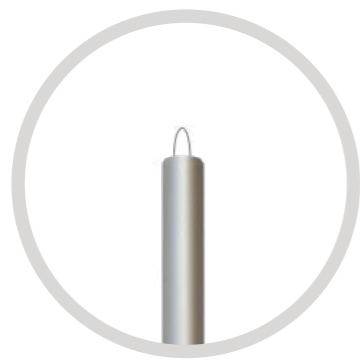

VERSIONE A BATTERIA,
SENZA ROSONE
**BATTERY OPERATED
VERSION, WITHOUT CANOPY**

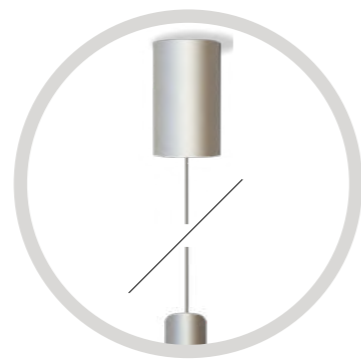

VERSIONE CABLATA,
CON ROSONE
**WIRED VERSION,
WITH CANOPY**

- 1. Laccato argento
- 2. Laccato oro rosa
- 3. Laccato nero opaco

- 1. Silver finish
- 2. Rose gold finish
- 3. Matt black finish

Fonte luminosa - Light source
220-240V: 1 x 3W LED module - IP65
110V: 1 x 3W LED module - IP65

Battery - dimmerabile / dimmable

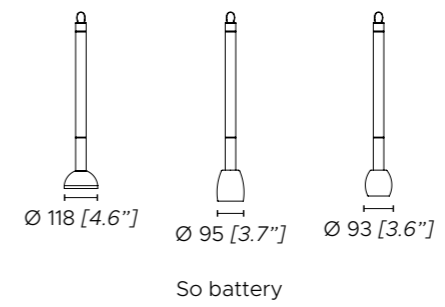
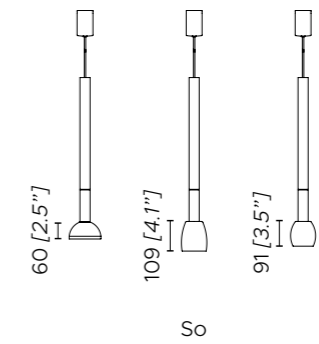



ACCESSORI / ACCESSORIES TENEBRA



1.



2.



3.

1. Diffusore cristallo sintetico, Venezia ambra
 2. Diffusore cristallo sintetico, Lente grigio
 3. Diffusore cristallo sintetico, Crystal Macedonia

1. Diffuser syntethic crystal, Venezia Amber
 2. Diffuser syntethic crystal, Grey lens
 3. Diffuser syntethic crystal, Crystal Macedonia

Accessori versione a batteria

ACCESSORI INCLUSI

- 
- 1 x staffa per attacco a soffitti + 1 x griplock +
 1 x bloccacavo + 1 x cavo in acciaio l. 2m +
 1 x gancio standard



ACCESSORI "A" (non inclusi)

- 1 x cavo in acciaio l. 2m + 1 x gancio design



ACCESSORI "B" (non inclusi)

- 1 x tirante + 2 x bloccacavo + 1 x cavo in acciaio l.10m
 + 6 x griplock

Battery operated version accessories

INCLUDED ACCESSORIES

- 1 x ceiling attachment + 1 x griplock + 1 x screw lock +
 1 x steel cable l. 2m + 1 x standard hook

"A" ACCESSORIES (not included)

- 1 x steel cable l. 2m + 1 x design hook

"B" ACCESSORIES (not included)

- 1 x tie rod + 2 x screw lock + 1 x steel cable l. 10m
 + 6 x griplock

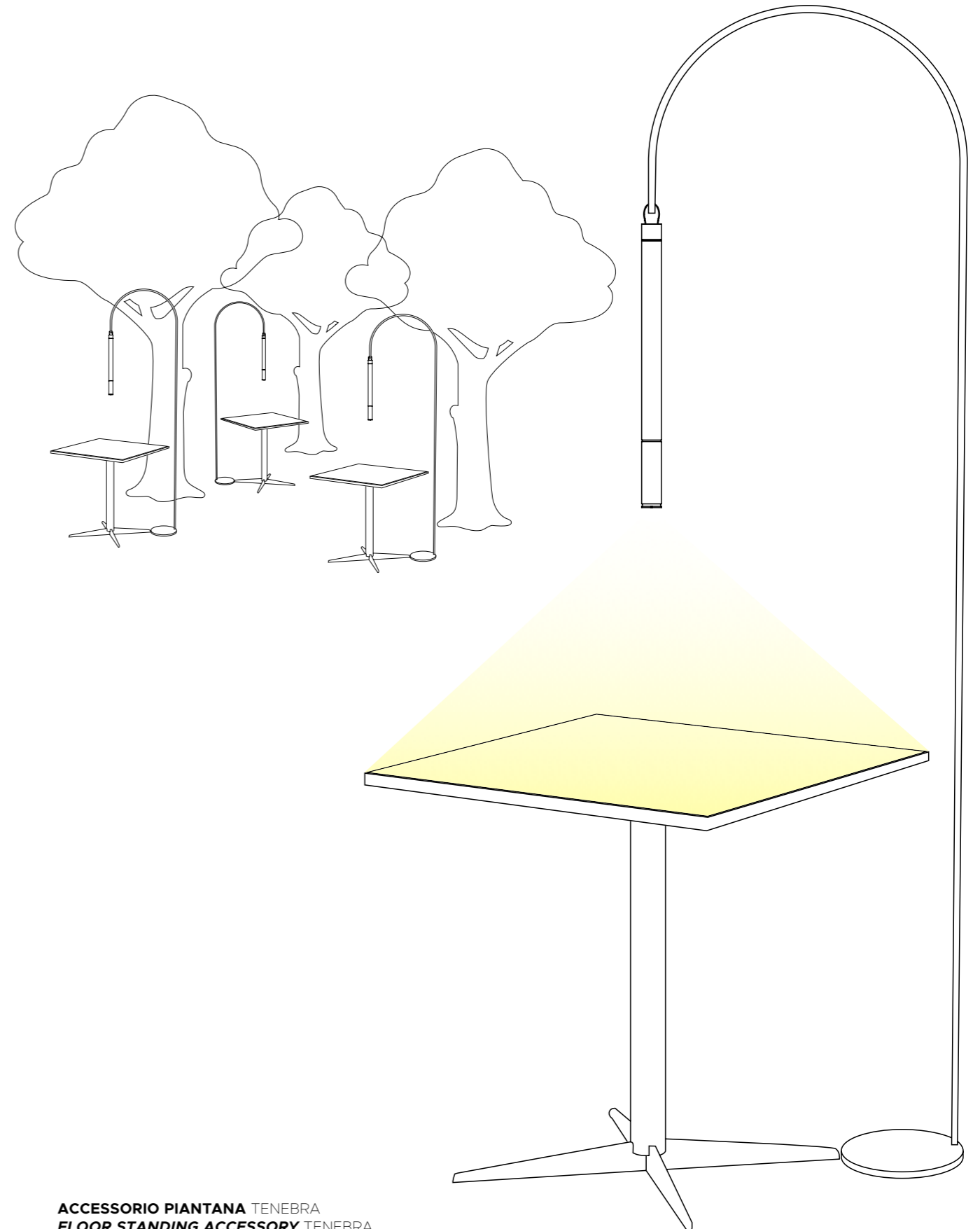

ACCESSORIO PIANTANA TENEBRA
 FLOOR STANDING ACCESSORY TENEBRA



THANKS TO

Graphic Project:

Claudia Parisi

Photo Creative Direction:

STUDIOBLUM

Styling:

Martina Caiazzo

Mise en page:

Martina Castiglieri

Photos:

Francesco Romeo

Lakeroom

Render:

Operavisual

Studio Massimiliano Raggi

MKV Design

Photos of page:

Casablanca Fotografia (p. 67)

Fabio Grande (p. 71)

Milène Servelle Photographe (p. 159)

Yvan Grubski Phothographer (p.7_i)

Francis Amiand Photographe (p. 62_out)

Stuart Pearce (p. 71_out)

Styling of page:

John Mac Donald, Tilburg (p. 38, 196)

BenchMark Design, Tilburg (p. 41)

MPMC Design, Monaco (FR) (p. 53)

NB-Studio, Moscow (p. 65)

Joaquim Homs (p. 67)

Alessandra Notarangelo Architetto, Italy (p. 71)

Grani Studio, Sochi (p. 110)

Tamma Architecture, Monaco (FR) (p. 159)

Goddard Little Fair, London (p. 190)

Maurizio Di Mauro Architetto, Italy (p. 192)

Maison Numéro 20 / Oscar Lucien Ono, Paris (p. 62_out)

Gunter & Co Interiors, London (p. 69_out)

FM Architettura d'interni, Italy (p. 71_out)

Thanks to:

MONOMIO

Ilya Barton

Jole Lombardini

Marco Billotti

Stefano Mandelli

Pietro Di Pace

Meroni e Colzani

CTS Salotti

Casa Casati

On House Milan

Thesign srl

Buro Tsum Restaurant, Moscow

Cavo Tagoo, Mykonos

Motel One Frankfurt Römer, Frankfurt

Fonteverde Hotel, San Casciano dei Bagni

Bartolo & Sons, Palermo

Egetemeier Wohnkultur, Germany

Sabrina Montecarlo, Monaco (FR)

Four Season Hotel Megeve, France

Print:

Grafiche Filacorda, Udine

@Contardi Lighting srl

02.2022