

 contardi

indoor



BLENDING  
TECHNOLOGY  
& CREATIVE  
DESIGN

## “Mentre mio padre stava dando forma alla luce, stavo imparando come modellare un’azienda”

Achille Carcano, Titolare



Paola & Achille Carcano

### 1. La nostra storia, la nostra famiglia *Our history, our family*

Contardi, una giovane azienda con una lunga storia. Il primo prodotto a marchio Contardi è stato lanciato nel 2006. Successivamente, l'azienda ha iniziato una crescita costante anno dopo anno, che si è consolidata negli ultimi anni a livello internazionale. Contardi è ora una solida realtà con sede produttiva ed amministrativa in Brianza, il cuore pulsante della manifattura Made in Italy. Tutto comincia grazie al genio creativo di Michele Carcano, che aveva una grande passione per la prototipazione. La sua esperienza nell'azienda Stilnovo gli consentì di sviluppare una notevole competenza nell'illuminazione. Da quel momento, gli eredi di Michele, Achille e Paola Carcano, hanno preso le redini dell'azienda e sono ora supportati da un team unito e compatto. Come in una famiglia allargata, alcuni dei suoi membri sono parte di Contardi sin dagli albori. Contardi è oggi sinonimo di servizio, qualità e flessibilità. Queste caratteristiche hanno consentito all'azienda di guadagnarsi la fiducia di architetti, interior designer e consulenti di illuminazione, figure professionali sempre alla ricerca di originalità e design decorativo e funzionale, oltre che di esperienza e servizio di alto livello.

*We are a young company with a long history. Our first Contardi branded product dates back to 2006, thereafter the company began to constantly grow year after year, and the expansion has consolidated in the last six years. Contardi is now a well-established company headquartered in the Brianza district - the beating heart of the "Made in Italy" manufacturing. Before then, Contardi had a 30-year history of successful collaborations, providing its lighting expertise to some of the most iconic companies on the Italian design scene. It all started from the creative genius of Michele Carcano, who had a real passion for prototyping and worked for Stilnovo - one of the first companies to build a reputation in lighting design. Fast-forward to today, and Michele Carcano's heirs - Achille and Paola Carcano - have taken the reins of the company, supported by a very close-knit team, more similar to an extended family working together, with some of its members having been part of it since its inception. Contardi is now synonymous with service, quality and flexibility, having become a reliable reference point for architects, interior decorators and lighting consultants who are in search of original and well-designed decorative and functional lighting as well as an unparalleled expertise and service.*

### 1a. Contardi USA

Il percorso aziendale di Contardi ha portato l'azienda ad affacciarsi sul mercato statunitense già nel 2015. Questo mercato ha oggi una grande importanza per il brand. Con l'apertura e presenza della filiale americana, Contardi risponde in tempo reale alle esigenze provenienti da questo mercato.

L'apertura della filiale americana ci garantisce un presidio diretto in uno dei punti nevralgici del mondo, con una forte presenza nell'e-commerce e l'ottenimento della certificazione ETL.

*Contardi's business path led the company to enter the US market as early as 2015. Today this market is of great importance for the brand. With the opening and presence of the American branch, Contardi responds in real time to the needs of this market.*

*The American branch, which is ETL certified, guarantees our brand a direct participation in one of the key regions of the world, with a strong presence in e-commerce.*

## “While dad was giving a shape to light, I was learning how to shape a company”

Achille Carcano, Owner

## 2. Contardi Contract Division

Lavoriamo fianco a fianco con architetti, interior designer e consulenti di illuminazione. Grazie a questo, Contardi ha sviluppato la capacità sia di tradurre i concetti dei designer, che di soddisfare le richieste del cliente e di rispettare il budget dei progetti. **Hotels, ristoranti, e yacht** diventano il palcoscenico della versatilità dei nostri prodotti, che si uniscono perfettamente all'ambiente circostante, indipendentemente dallo stile e dalle caratteristiche del progetto stesso. La Divisione Contract Contardi offre un servizio mirato in base alle richieste del cliente:

*We work closely with architects, interior decorators and lighting designers, so we are able to catch and translate the designer's concepts, meeting the client's needs and the budget of the project. **Hotels, restaurants and yachts** become stages where the versatility of products blends perfectly with the surroundings, independently from the style and the characteristics of the project itself. Contardi Contract Division offers a dedicated service on customer requests:*

**BESPOKE  
MODIFIED STOCK  
VALUE ENGINEERED**



The Hoxton, Rome



Shangri La, Hong Kong



Mayfair Townhouse, London



The Address Downtown, Dubai



Lutetia Hotel, Paris



The Carlyle, New York

### 3. Sartorialità e tecnologia *Tailoring and avant-garde technology*

Per Contardi è stato più volte usato l'appellativo di **"Couturier della Luce"**. Nel corso degli anni, siamo riusciti a guadagnarci questa reputazione per il nostro approccio sartoriale, per la varietà dei materiali usati, per l'eleganza delle finiture e per la loro combinazione con le più innovative tecnologie LED. La nostra collezione è disegnata per assicurare che la qualità dell'illuminazione risponda alle esigenze contemporanee.

*Internationally renowned as the "Couturier of Contemporary Lighting", we have earned this reputation over the years for our skilful sartorial approach, for the variety of materials used, as well as the elegance of the finishes combined with the most innovative LED technology, all designed to ensure that the quality of the lighting responds to contemporary requirements.*

### 4. Flessibilità *Flexibility*

La flessibilità è la nostra forza. Ci contraddistingue. L'ampia varietà di stile rappresenta la capacità di interpretare le diverse personalità dei nostri clienti e di adattarsi a molteplici contesti.

*Flexibility is our strength and what distinguishes us from the rest. Style variety does not mean a lack of identity though. On the contrary, it means a capacity to interpret different styles and to adapt to different settings.*

### 5. Sostenibilità *Sustainability*

Il nostro impegno per un business sempre più sostenibile è costante. Siamo ora pronti per la nuova sfida di ridurre ulteriormente il nostro impatto ambientale con una serie di obiettivi che miriamo a raggiungere e che rappresentano il nostro orientamento in termini di sostenibilità.

*Our commitment to an increasingly sustainable business has emerged over the course of the last few years and, after obtaining some great achievements, we are now ready for a new challenge to further reduce our environmental impact with a clear set of targets, which constitute our Pole Star in terms of sustainability.*

### 6. Certificazioni *Certification*

La presenza di un Brand sul mercato internazionale non può oggi prescindere dalle certificazioni. Contardi risponde a questa esigenza investendo risorse e competenza. Oggi l'azienda è certificata ETL per il mercato americano e CCC per il mercato cinese. Grazie all'ufficio tecnico interno, Contardi riesce a soddisfare le richieste di certificazioni quali: SABER per l'Arabia Saudita, CoC per il Marocco, EAC per il mercato russo.

*Today, a Brand's presence on the international market requires the ability to provide certifications. Contardi responds to this need by investing resources and expertise. Our company is ETL certified for the American market, and CCC for the Chinese market. Thanks to the internal technical office, Contardi is able to satisfy requests for certifications such as SABER for Saudi Arabia, CoC for Morocco, and EAC for the Russian market.*



<b>A</b>	13 <b>AIR</b> 21 <b>ARCIPELAGO</b> so, ta 29 <b>ASIA</b> so, ap, ta, pl 39 <b>AUDREY</b> so, ta, fl
<b>B</b>	47 <b>BEAM</b> 53 <b>BOGOTÀ</b>
<b>C</b>	59 <b>CALYPSO</b> so, fl 77 <b>CUBE</b>
<b>D</b>	81 <b>DISCUS</b> so, ap, pl 91 <b>DORIAN</b> so, fl
<b>E</b>	99 <b>ECLISSE 2.0</b> 103 <b>EMMA</b> ap, ta, pl
<b>F</b>	111 <b>FLEXILED</b> ap, fl 117 <b>FLY</b> so, ap, picture
<b>G</b>	129 <b>G+T</b> so, ap, reading, battery
<b>K</b>	143 <b>KUBRIC</b>
<b>M</b>	147 <b>MANHATTAN</b> 151 <b>MELANOCETUS</b> 157 <b>MIKADO</b> so, ap, ta, fl 169 <b>MUSE LANTERN</b>
<b>O</b>	173 <b>ONGO</b> battery

<b>S</b>	177 <b>SOLITARIO</b> so, ap, pl 187 <b>STARDUST</b> 191 <b>STICK</b> so, ap
<b>T</b>	203 <b>TENEBRA</b> wired, battery
<b>U</b>	209 <b>UP</b> ap, ta, fl
<b>V</b>	215 <b>VEGAS</b>

## CONTARDI SARTORIA

*Contardi Tailoring*

<b>A</b>	2i <b>ATHENA</b>
<b>C</b>	6i <b>CIRCUS</b> so, pl 12i <b>COCO MEGA &amp; DELUXE</b> ap, ta 16i <b>COCO &amp; COCONETTE</b>
<b>O</b>	22i <b>OVALE</b> ta, fl
<b>T</b>	26i <b>TONDA</b> ap, ta, fl

**Lampada a sospensione**  
Suspension lamp



Air  
13

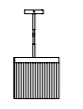

Arcipelago  
21



Asia  
29



Audrey  
39

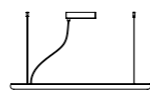

Bogotá  
53



Calypso  
59

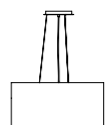

Circus & Circus LED  
6i



Discus  
81



Dorian  
91

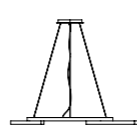

Eclisse 2.0  
99

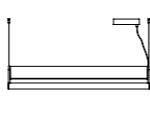

Fly  
117



G+T  
129



Kubric  
143

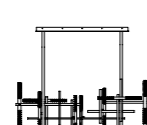

Mikado  
157



Solitario  
177

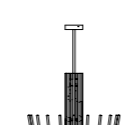

Stardust  
187

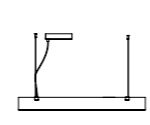

Stick  
191

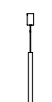

Tenebra  
203

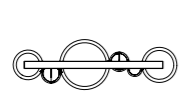

Vegas  
215

**Lampada a parete**  
Wall lamp

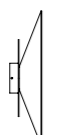

Asia  
29

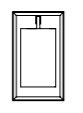

Coco Mega & Deluxe  
12i



Coco & Coconette  
16i

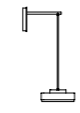

Discus  
81



Emma  
103

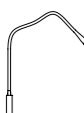

Flexiled  
111

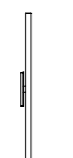

Fly  
117

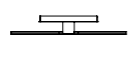

Fly picture  
117

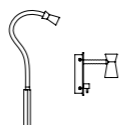

G+T  
129



Manhattan  
147

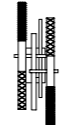

Mikado  
157



Solitario  
177



Stick  
191



Tonda  
26i



Up  
209

**Lampada da lettura**  
Reading lamp



Flexiled  
111



G+T  
129



Manhattan  
147



Tonda  
26i



Up  
209

**Lampada a soffitto**  
Ceiling lamp

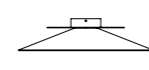

Asia  
29

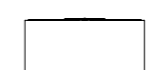

Circus & Circus LED  
6i

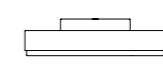

Discus  
81



Emma  
103



Melanocetus  
151



Solitario  
177

**Lampada da terra**  
Floor lamp



Audrey  
39

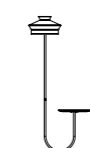

Calypso  
59



Cube  
77



Dorian  
91

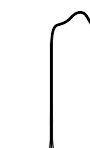

Flexiled  
111



Mikado  
157



Muse Lantern  
169



Ovale  
22i



Tonda  
26i



Up  
209

**Lampada da tavolo**  
Table lamp



Arcipelago  
21



Asia  
29



Athena  
2i



Audrey  
39



Beam  
47



Coco Mega & Deluxe  
12i



Emma  
103

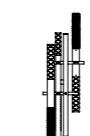

Mikado  
157



Ongo  
173



Ovale  
22i



Tonda  
26i



Up  
209

**Lampada a batteria**  
Battery lamp



G+T battery  
129



Ongo  
173



Tenebra  
203

**Air**  
Adam Tihany







**DOPPIA EMISSIONE:** LUCE DIRETTA E INDIRETTA  
**DOUBLE EMISSION:** DIRECT AND INDIRECT LIGHT

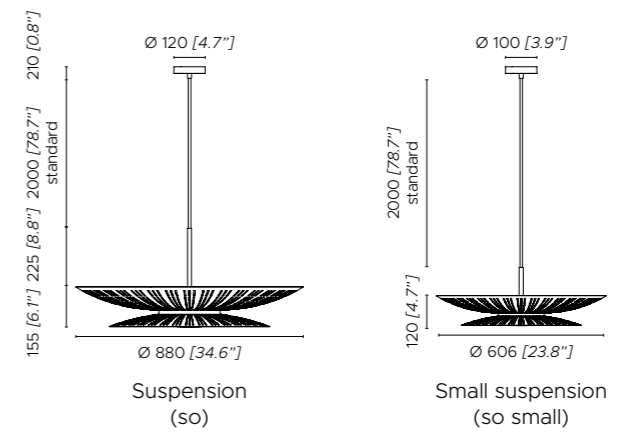

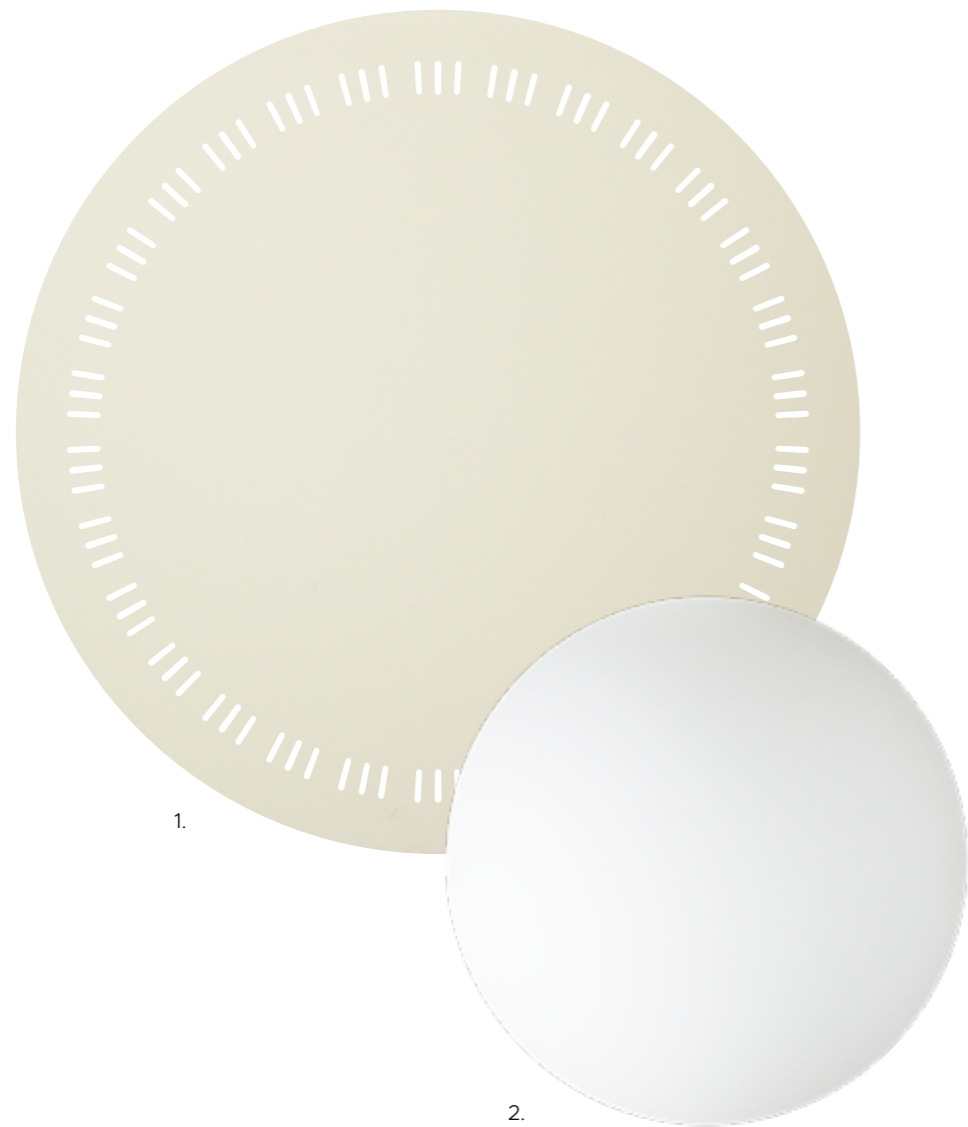

1. "GREEN CAST" color crema

2. Diffusore "GREEN CAST" bianco opale

ⓘ Disponibile su richiesta "GREEN CAST" colore nero  
Quantità minima: 5 pezzi per dimensione

1. Cream-coloured "GREEN CAST"

2. Opal white "GREEN CAST" diffuser

ⓘ Black-coloured "GREEN CAST" available on demand  
Minimum quantity: 5 pieces for size





# WHAT'S AIR?

The eco-friendly AIR suspension light, conceived by the renowned **Adam Tihany**

Cos'è il materiale "GREEN CAST®"?

- **100%** granuli di PMMA provenienti da prodotti pre e post consumer
- Materia prima **100%** rigenerata

Quali sono i vantaggi del "GREEN CAST®"?

- **100%** riciclabile
- **Rispetto** delle risorse primarie
- **Riduzione** dell'uso di materie prime
- **Ri-utilizzo** di ciò che è considerato un rifiuto

What is "GREEN CAST®" material?

- **100%** PMMA granules from pre and post consumer
- **100%** regenerated raw material

Which are "GREEN CAST®" advantages?

- **100%** recyclable
- **Respect** of primary resources
- **Reduction** in the use of raw materials
- **Re-use** of what is considered waste

## AIR FOR A MORE SUSTAINABLE IMPACT ON THE WORLD OF DESIGN

PER UN **IMPATTO PIÙ SOSTENIBILE NEL MONDO DEL DESIGN**



Fonte luminosa - Light source

**220 - 240V:**

**So superiore/upper** 1 x 7.5W Strip LED;  
**inferiore/lower** 1 x 14.3W LED module; 2700 K; CRI: >90  
**So small superiore/upper** 1 x 3.5W Strip LED;  
**inferiore/lower** 1 x 9W LED module; 2700 K; CRI: >90

Dimmerazione a taglio di fase/Triac - altri sistemi di dimmerazione (DALI e 1-10V) disponibili su richiesta  
*Phase cut/Triac dimming - alternative dimming systems (DALI and 1-10V) available on demand*

**110V:**

**So superiore/upper** 1 x 7.5W Strip LED;  
**inferiore/lower** 1 x 14.3W LED module; 2700 K; CRI: >90  
**So small superiore/upper** 1 x 3.5W Strip LED;  
**inferiore/lower** 1 x 9W LED module; 2700 K; CRI: >90

Dimmerazione a taglio di fase/Triac - dimmerazione 1-10V disponibile su richiesta  
*Phase cut/Triac dimming - 1-10V dimming system available on demand*

Arcipelago

Servomuto



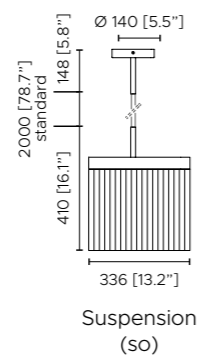



1. Struttura ottone satinato

- 2. Frange verde salvia
- 3. Frange blu nebbia
- 4. Frange cognac
- 5. Frange sabbia
- 6. Frange aragosta
- 7. Frange ruggine

**Fonte luminosa - Light source**

**220 - 240V:**  
1 x 12W Custom LED; 3000 K; CRI: >90

**Ta**  
Dimmerabile a tre intensità sulla base (100% - 70% - 30%)  
*Dimmable with three intensity levels on the base (100% - 70% - 30%)*

1. Satin brass frame

- 2. Sage green colour fringes
- 3. Fog blue colour fringes
- 4. Cognac colour fringes
- 5. Sand colour fringes
- 6. Aragosta colour fringes
- 7. Rust colour fringes

**110V:**  
1 x 12W Custom LED; 3000 K; CRI: >90

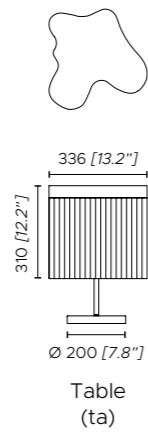

**Asia**  
Federico Peri



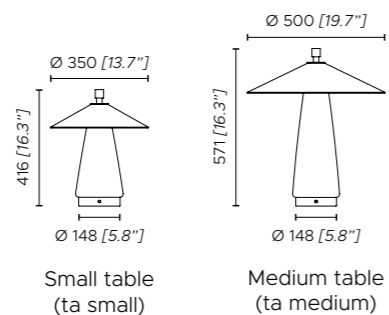

Small table  
(ta small)Medium table  
(ta medium)

1. Struttura nickel dorato satinato
2. Struttura bronzo-nickel spazzolato
3. Vetro trasparente

4. Paralume cotone bianco (esterno e interno)
5. Paralume cotone antracite (ta - so: esterno; ap - pl: interno) e cotone bianco (ta - so: interno; ap - pl: esterno)

6. Diffusore vetro bianco opale

1. Satin golden nickel frame
2. Brushed bronze-nickel frame
3. Transparent glass

4. White cotton shade (inside and outside)
5. Anthracite cotton shade (ta - so: outside; ap - pl: inside) and white cotton (ta - so: inside; ap - pl: outside)

6. Opal white glass diffuser

#### Fonte luminosa - Light source

##### 220 - 240V:

- Ta small 1 x 13W Strip LED; 2700 K; CRI: >90
- Ta medium 1 x 20W Strip LED; 2700 K; CRI: >90
- Ap - pl small 1 x 32W COB LED; 2700 K; CRI: >90
- Ap - pl - so medium 1 x 37W COB LED; 2700 K; CRI: >90
- Ap - pl - so large 1 x 40W COB LED; 2700 K; CRI: >90

##### Ta

Dimmerabile, interruttore push sulla base  
Dimmable, push switch on the base

##### Ap - pl - so

Dimmerazione a taglio di fase/Triac - altri sistemi di dimmerazione (DALI e 1-10V) disponibili su richiesta  
Phase cut/Triac dimming - alternative dimming systems (DALI and 1-10V) available on demand

##### 110V:

- Ta small 1 x 13W Strip LED; 2700 K; CRI: >90
- Ta medium 1 x 20W Strip LED; 2700 K; CRI: >90
- Ap - pl small 1 x 32W COB LED; 2700 K; CRI: >90
- Ap - pl - so medium 1 x 37W COB LED; 2700 K; CRI: >90
- Ap - pl - so large 1 x 40W COB LED; 2700 K; CRI: >90

##### Ta

Dimmerabile, interruttore push sulla base  
Dimmable, push switch on the base

##### Ap - pl - so

Dimmerazione a taglio di fase/Triac - dimmerazione 1-10V disponibile su richiesta  
Phase cut/Triac dimming - 1-10V dimming system available on demand



DOUBLE-SIDED SHADE,  
**ANTHRACITE  
& WHITE  
COTTON**

---

DIFFUSORE BIFACCIALE, COTONE ANTRACITE E BIANCO



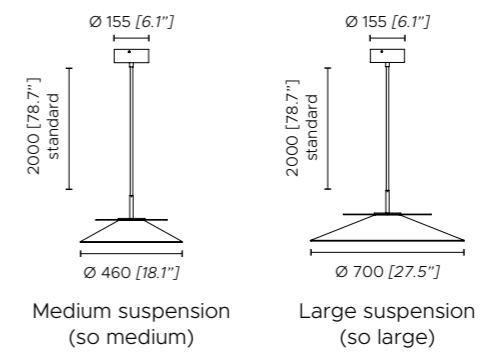
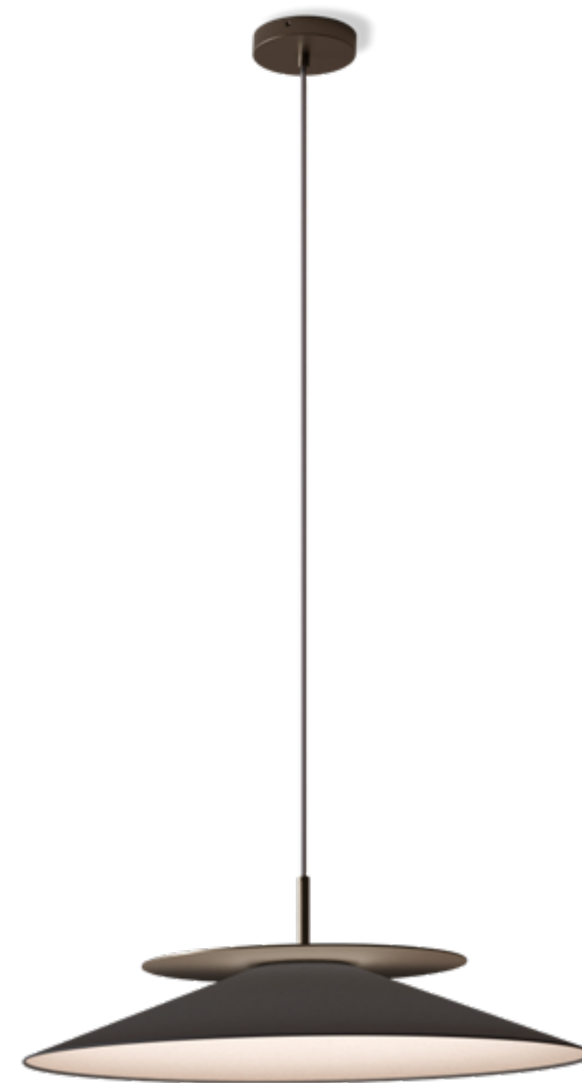

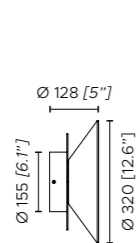

Small wall/ceiling  
(ap/pl small)

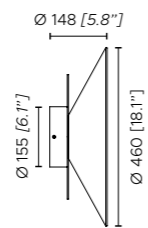

Medium wall/ceiling  
(ap/pl medium)

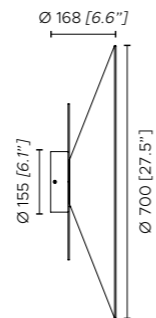

Large wall/ceiling  
(ap/pl large)



# Audrey

Massimiliano Raggi



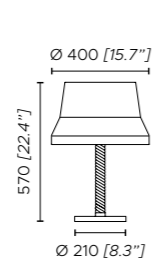

Medium table  
(ta medium)

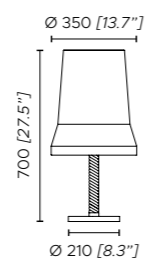

Large table  
(ta large)



- 1. Base laccato nero lucido
- 2. Stelo in corda di seta intrecciata nera
- 3. Paralume cotone bianco
- 4. Bouclé color sabbia
- 5. Passamaneria in velluto senape
- 6. Passamaneria in velluto arancione
- 7. Passamaneria in velluto blu avio
- 8. Passamaneria in velluto nera

- 1. Glossy black lacquered base
- 2. Stem in black braided silk rope
- 3. White cotton shade
- 4. Sand colour bouclé
- 5. Mustard colour velvet trim
- 6. Orange colour velvet trim
- 7. Aviation blue colour velvet trim
- 8. Black colour velvet trim

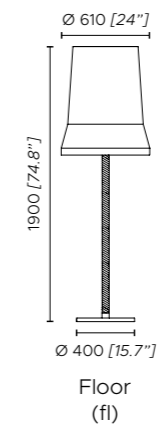

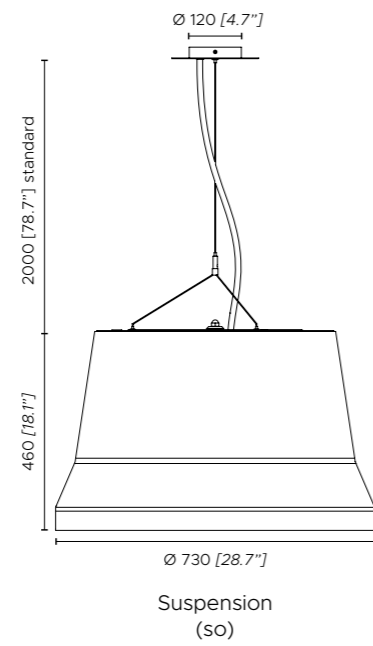

**Fonte luminosa - Light source**

**220 - 240V:**

Ta 1 x 13W E27 LED  
FI - so 3 x 14W E27 LED

**110V:**

Ta 1 x 13W E26 LED  
FI - so 3 x 14W E26 LED

**Ta**

Disponibile su richiesta versione con dimmer su cavo, compatibile solo con lampadine LED dimmerabili  
*Dimmer switch on the cable available on demand, compatible with dimmable LED light bulbs only*

**So**

Compatibile con sistemi di controllo remoto in caso di utilizzo di lampadine LED dimmerabili  
*Compatible with remote control systems when dimmable LED bulbs are used*





**Beam**  
MKV Design



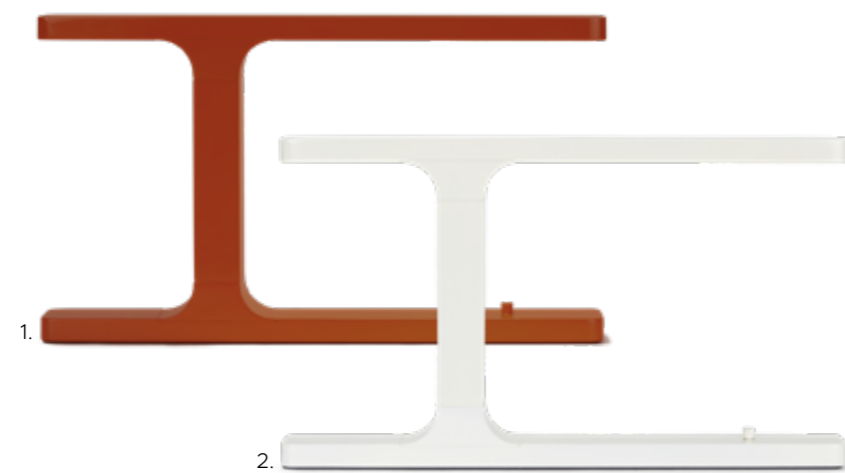

1. Laccato arancione scuro  
2. Laccato bianco perla

*Altri colori disponibili su richiesta*

**Fonte luminosa - Light source**

**220 - 240V:**  
2 x 4W Strip LED; 2700 K; CRI: >90

1. Dark orange lacquered  
2. Pearl white lacquered

*Other colours available on demand*

**110V:**  
2 x 4W Strip LED; 2700 K; CRI: >90

Luce orientabile (180°), tre posizioni: sinistra, destra, centrale - comando sulla base  
*Adjustable light (180°), three positions: left, right and central - switch on the base*



NON MUOVERE LA LAMPADA, MUOVI LA LUCE

DO NOT  
MOVE THE  
LAMP,  
**MUOVE  
THE  
LIGHT**

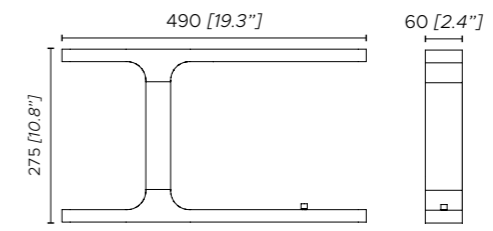

# Bogotá

Massimiliano Raggi



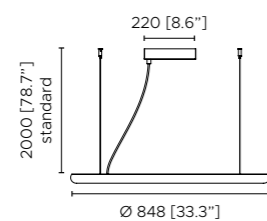

Small suspension  
(so small)

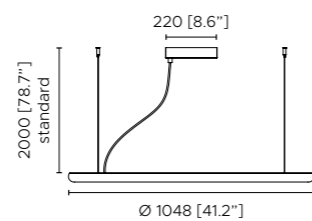

Large suspension  
(so large)

1. Anello in legno tinto nero

- 2. Rivestimento diffusore in cotone bianco
- 3. Rivestimento diffusore in tessuto effetto marmo bianco Calacatta
- 4. Rivestimento diffusore in paglia di Vienna

**Fonte luminosa - Light source**

**220 - 240V:**

**Small** 1 x 39W Panel LED; 3000 K; CRI: >90  
**Large** 1 x 48W Panel LED; 3000 K; CRI: >90

Dimmerazione a taglio di fase/Triac - altri sistemi di dimmerazione (DALI e 1-10V) disponibili su richiesta  
*Phase cut/Triac dimming - alternative dimming systems (DALI and 1-10V) available on demand*

1. Black stained wooden ring

- 2. White cotton diffuser
- 3. White Calacatta marble printed fabric diffuser
- 4. Vienna straw diffuser

**110V:**

**Small** 1 x 39W Panel LED; 3000 K; CRI: >90  
**Large** 1 x 48W Panel LED; 3000 K; CRI: >90

Dimmerazione a taglio di fase/Triac - dimmerazione 1-10V disponibile su richiesta  
*Phase cut/Triac dimming - 1-10V dimming system available on demand*



EFFETTO **MARMO STAMPATO** SU TESSUTO  
**PRINTED MARBLE EFFECT ON FABRIC**



**PAGLIA DI VIENNA** LAVORATA A MANO  
*HANDCRAFT VIENNA STRAW*

Calypso

Servomuto









Suspension  
(so)



- 1. Struttura ottone satinato
- 2. Corda in seta intrecciata verde muschio
- 3. **Paralume so:** Antigua, Guadaloupe, Martinique
- 4. Diffusore vetro trasparente

**Fonte luminosa - Light source**

**220 - 240V:**  
1 x 14W E27 LED

- 1. Satin brass frame
- 2. Moss green braided silk rope
- 3. **So shade:** Antigua, Guadaloupe, Martinique
- 4. Transparent glass diffuser

**110V:**  
1 x 14W E26 LED

Compatibile con sistemi di controllo remoto in caso di utilizzo di lampadine LED dimmerabili  
Compatible with remote control systems when dimmable LED bulbs are used

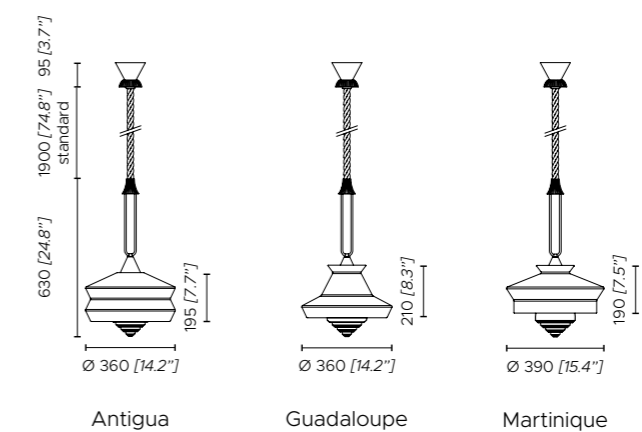





# CALYPSO SO XL

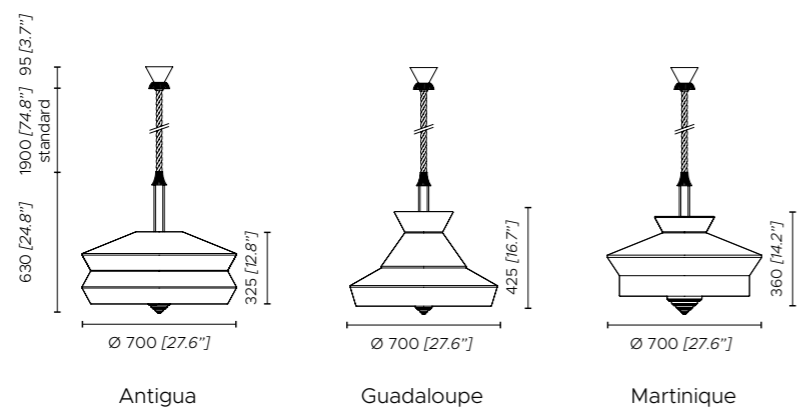

### CALYPSO SO



Antigua  
Mint



Guadeloupe  
Mint



Martinique  
Yellow



Antigua  
Black



Guadeloupe  
Black



Martinique  
Black



Antigua  
Sale & Pepe



Guadeloupe  
Sale & Pepe



Martinique  
Building

### CALYPSO SO XL



Antigua  
Mint



Guadeloupe  
Sale & Pepe



Martinique  
Yellow



CALYPSO  
**FLOOR  
+TABLE**

Servomuto

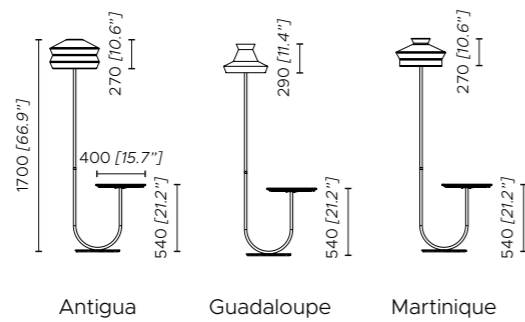

- 1. Struttura laccato nero seta opaco
- 2. Anello in ottone satinato
- 3. Marmo verde Guatemala
- 4. Pelle verde
- 5. **Paralume fl:** Antigua, Guadeloupe, Martinique

**Fonte luminosa - Light source**

**220 - 240V:**  
1 x 14W E27 LED dimmerabile - *dimnable*

Dimmerabile a piede  
*Dimmable with foot control*

- 1. Matt black silk lacquered frame
- 2. Satin brass ring
- 3. Green Guatemala marble
- 4. Green leather
- 5. **FI shade:** Antigua, Guadeloupe, Martinique

**110V:**  
1 x 14W E26 LED dimmerabile - *dimnable*



DETAILS  
MATTER:  
**LEATHER,  
MARBLE,  
BRASS**

I DETTAGLI CONTANO: PELLE, MARMO, OTTONE

# Cube

Massimiliano Raggi





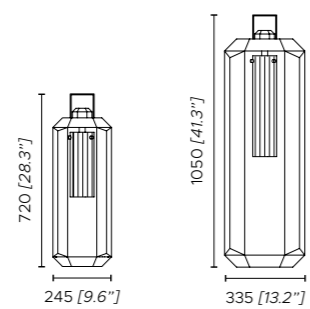

Small floor  
(fl small)

Large floor  
(fl large)



- 1. Struttura bronzo spazzolato
- 2. Interno laccato oro
- 3. Diffusore plexiglass rigato

**Fonte luminosa - Light source**

**220 - 240V:**  
1 x 14W E27 LED dimmerabile - *dimnable*

Dimmerabile a piede  
*Dimmable with foot control*

- 1. Satin bronze frame
- 2. Gold lacquered inside
- 3. Striped plexiglass diffuser

**110V:**  
1 x 14W E26 LED dimmerabile - *dimnable*



# Discus

MKV Design

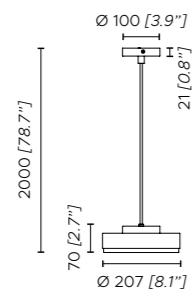
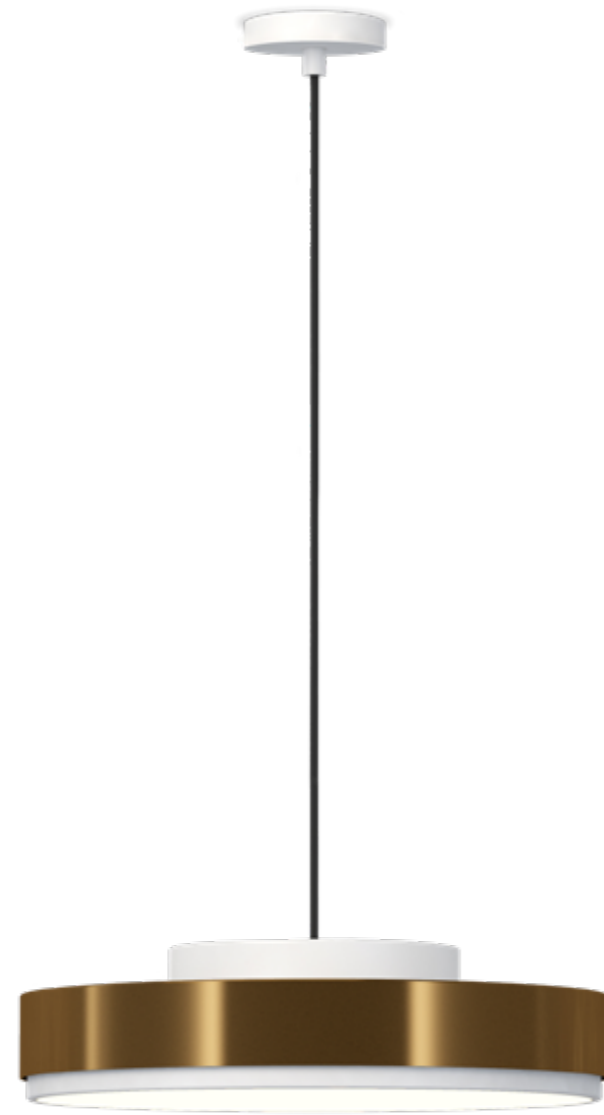

Small suspension  
(so small)

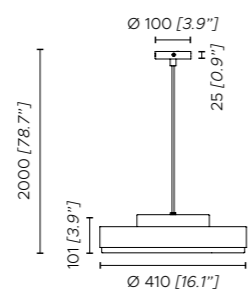

Large suspension  
(so large)



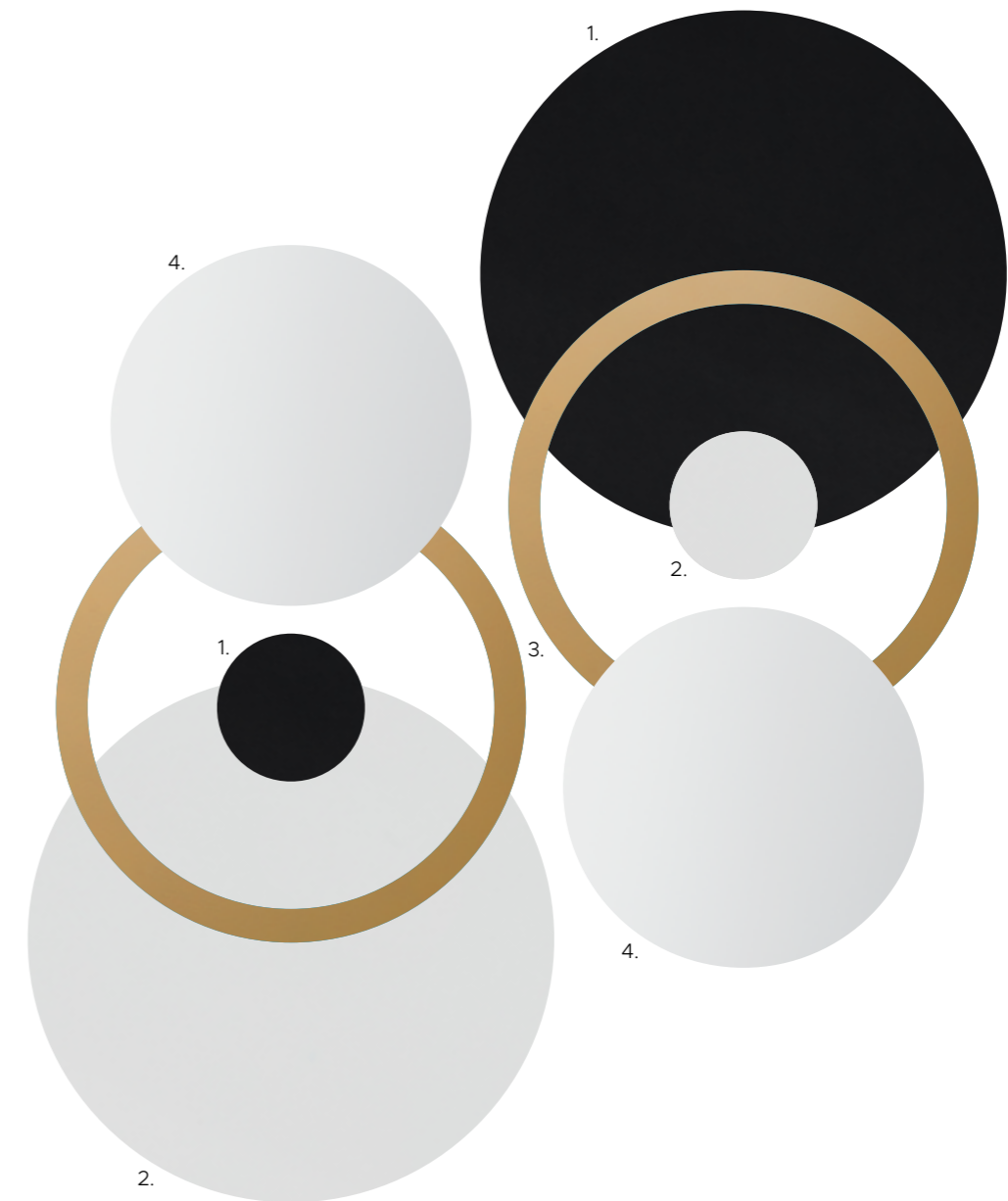
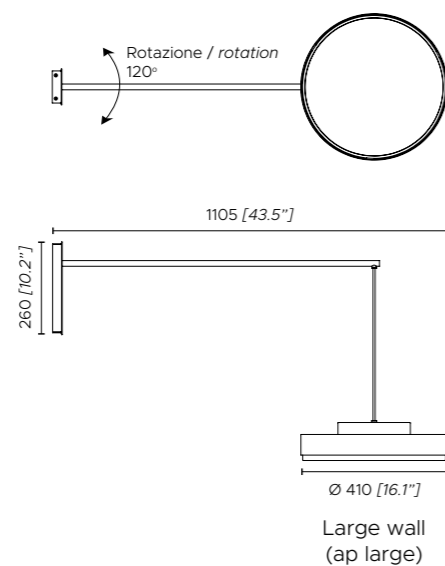

1. Laccato nero seta opaco
2. Laccato bianco opaco
3. Ottone semi-lucido

4. Diffusore bianco opaco

#### Fonte luminosa - Light source

##### 220 - 240V:

So - ap - pl small 1 x 14.3W LED module; 2700 K; CRI: >90

So - ap - pl large 1 x 36W LED module; 2700 K; CRI: >90

Dimmerazione a taglio di fase/Triac - altri sistemi di dimmerazione (DALI e 1-10V) disponibili su richiesta  
*Phase cut/Triac dimming - alternative dimming systems (DALI and 1-10V) available on demand*

1. Matt black silk lacquered
2. Matt white lacquered
3. Semi-polished brass

4. Opal white diffuser

##### 110V:

So - ap - pl small 1 x 14.3W LED module; 2700 K; CRI: >90

So - ap - pl large 1 x 36W LED module; 2700 K; CRI: >90

Dimmerazione a taglio di fase/Triac - dimmerazione 1-10V disponibile su richiesta  
*Phase cut/Triac dimming - 1-10V dimming system available on demand*

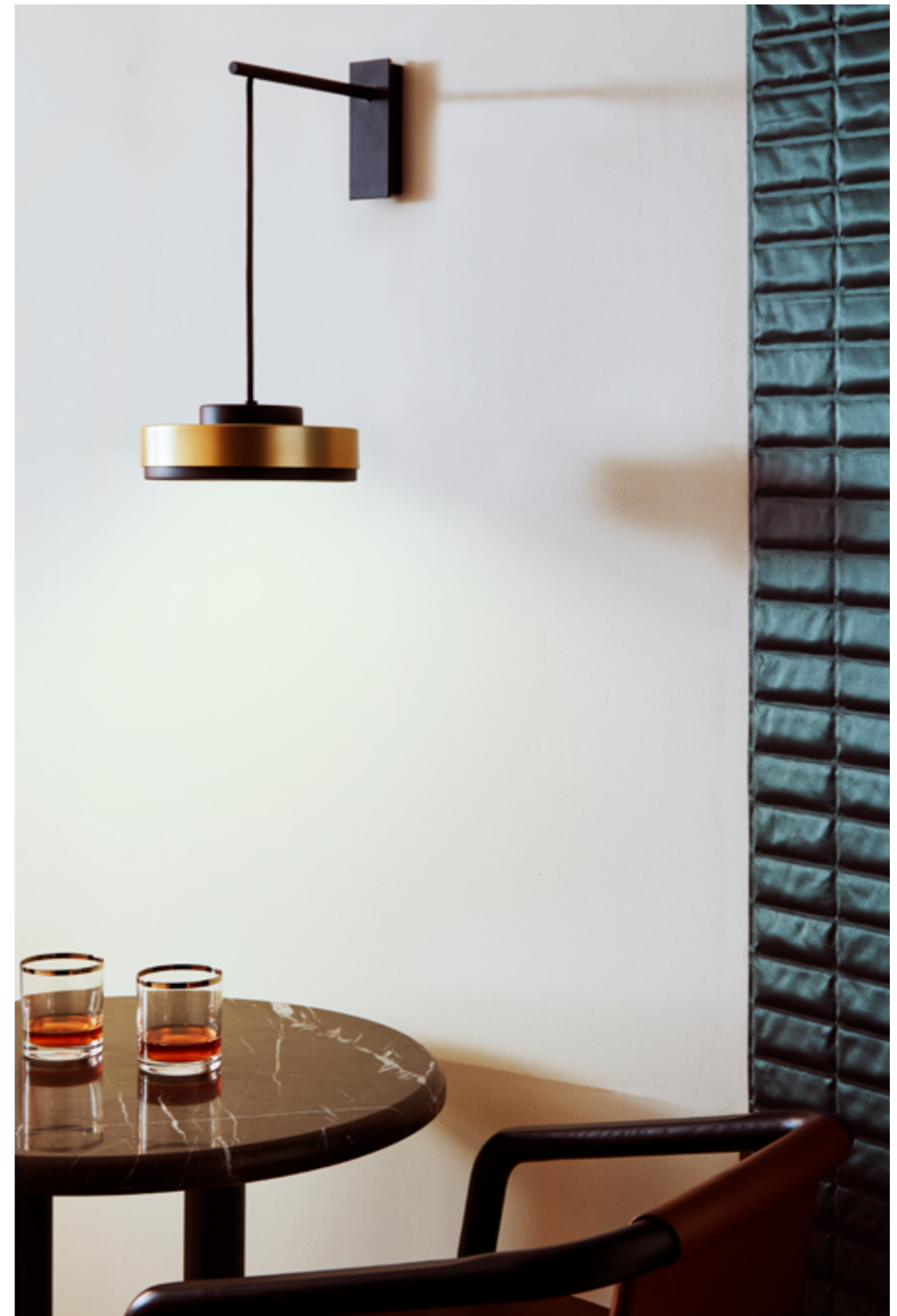
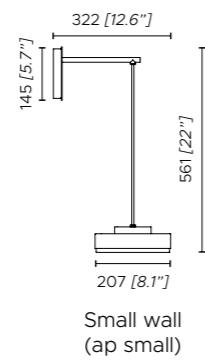

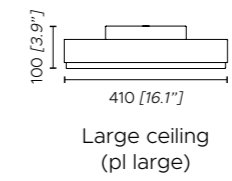
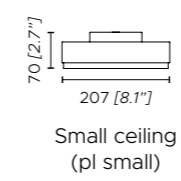

**Dorian**  
Marcello Colli





1. Struttura bronzo spazzolato chiaro opaco
2. Struttura laccato nero seta opaco
3. Diffusore: specchio fumè, plexiglass con serigrafia a nido d'ape

#### Fonte luminosa - Light source

##### 220 - 240V:

FI 1 x 55W Custom LED; 3000 K; CRI: >90  
So small 1 x 17W Custom LED; 3000 K; CRI: >90

FI  
Dimmerabile a piede  
*Dimmable with foot control*

**So small**  
Dimmerazione a taglio di fase/Triac - altri sistemi di dimmerazione (DALI e 1-10V) disponibili su richiesta  
*Phase cut/Triac dimming - alternative dimming systems (DALI and 1-10V) available on demand*

1. Matt light satin bronze frame
2. Matt black silk lacquered frame

3. Diffuser: smoked coloured mirror, plexiglass with honeycomb effect screen printing

##### 110V:

FI 1 x 55W Custom LED; 3000 K; CRI: >90  
So small 1 x 17W Custom LED; 3000 K; CRI: >90

FI  
Dimmerabile a piede  
*Dimmable with foot control*

**So small**  
Dimmerazione a taglio di fase/Triac - dimmerazione 1-10V disponibile su richiesta  
*Phase cut/Triac dimming - 1-10V dimming system available on demand*





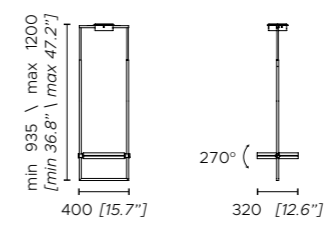

Small suspension  
(so small)

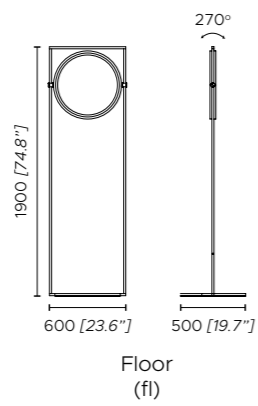

# Eclisse 2.0

Massimiliano Raggi





1. Rosone bronzo spazzolato
2. Anello grande in legno bronzo scuro
3. Anelli piccoli in legno bronzo chiaro
4. Dischi diffusori in alicrite effetto alabastro

#### Fonte luminosa - Light source

##### 220 - 240V:

1 x 28W Panel LED + 1 x 17W Panel LED;  
3000 K; CRI: >90

Dimmerazione a taglio di fase/Triac - altri sistemi di dimmerazione (DALI e 1-10V) disponibili su richiesta  
*Phase cut/Triac dimming - alternative dimming systems (DALI and 1-10V) available on demand*

1. Satin bronze canopy
2. Larger ring in dark bronze painted wood
3. Smaller rings in light bronze painted wood
4. Alabaster effect alycrite discs diffusers

##### 110V:

1 x 28W Panel LED + 1 x 17W Panel LED;  
3000 K; CRI: >90

Dimmerazione a taglio di fase/Triac - dimmerazione 1-10V disponibile su richiesta  
*Phase cut/Triac dimming - 1-10V dimming system available on demand*

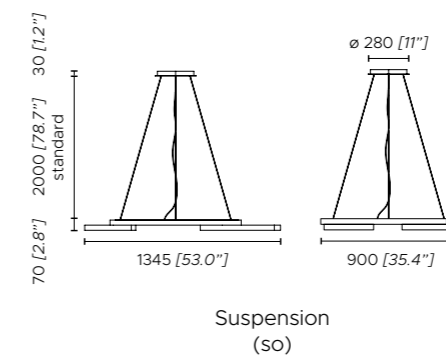

Emma  
Contardi Studio



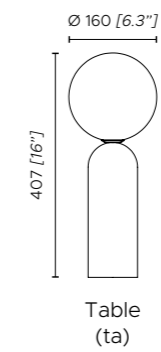

**Fonte luminosa - Light source**

**220 - 240V:**

Ap - pl 1 x 7W G9 LED  
Ta 1 x 7W G9 LED dimmerabile - *dimnable*

**110V:**

Ap - pl 1 x 7W G9 LED  
Ta 1 x 7W G9 LED dimmerabile - *dimnable*

**Ap - pl**

Compatibile con sistemi di controllo remoto in caso di utilizzo di lampadine LED dimmerabili  
*Compatible with remote control systems when dimmable LED bulbs are used*

**Ta**

Dimmerabile su cavo  
*Dimmable on the cable*

- 1. Marmo verde Guatemala
- 2. Marmo bianco Calacatta
- 3. Diffusore sfera bianca opale

- 1. Green Guatemala marble
- 2. White Calacatta marble
- 3. Opal white globe diffuser

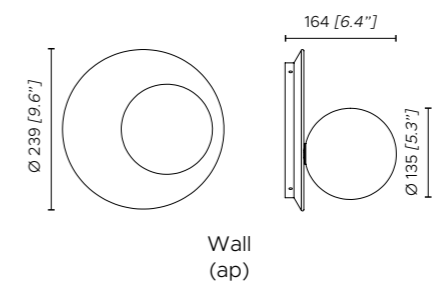
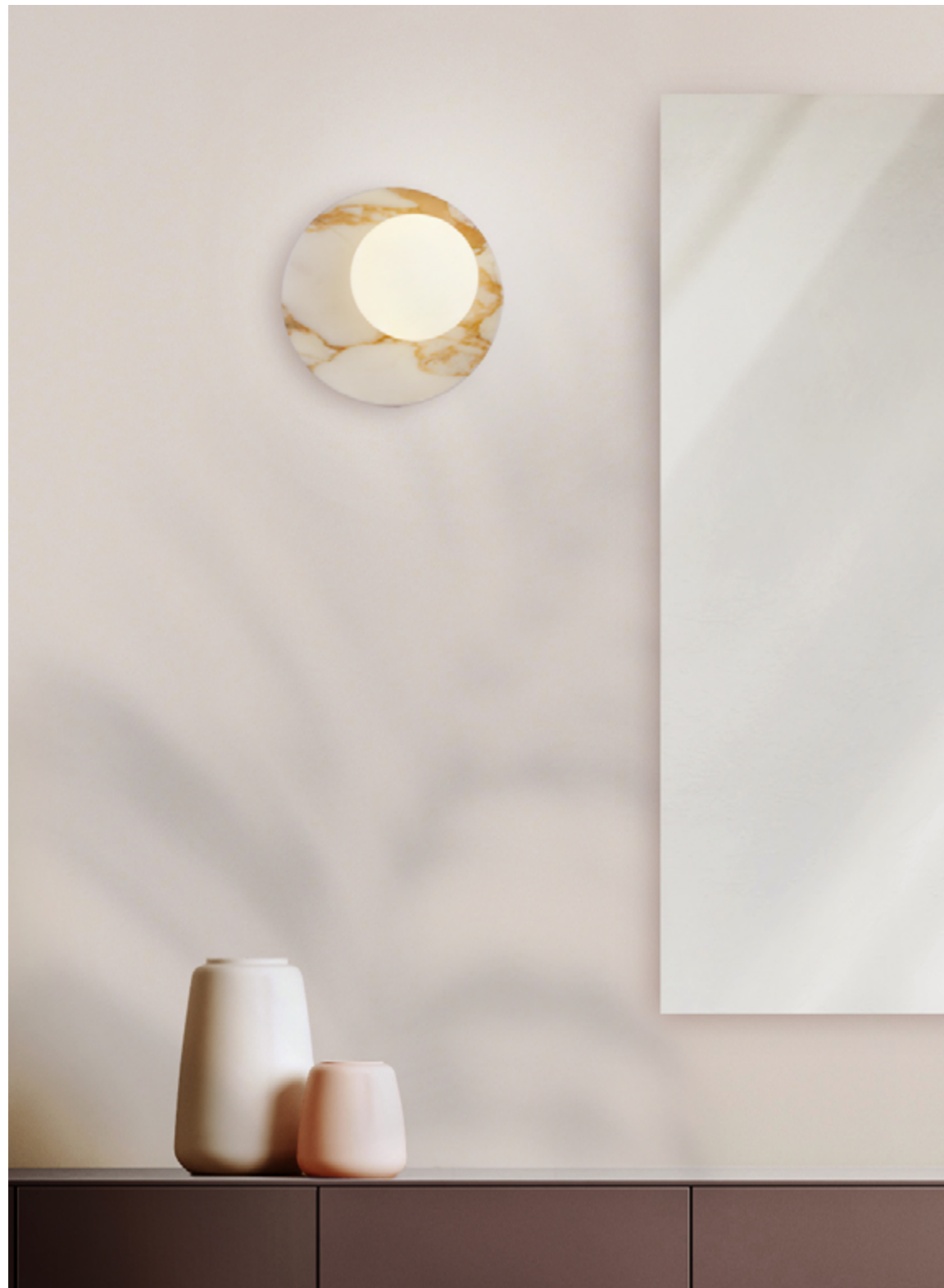

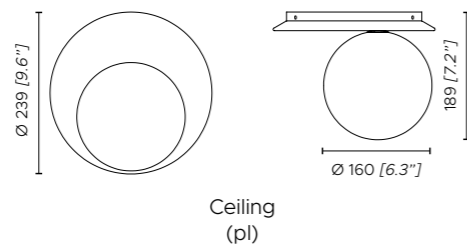



# Flexiled

King & Roselli



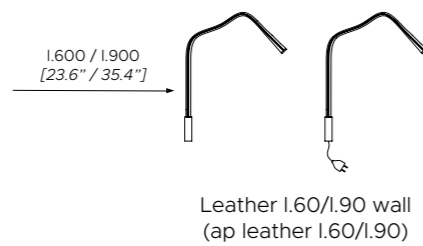

Leather I.60/I.90 wall  
(ap leather I.60/I.90)



- 1. Base laccato nero seta opaco (floor lamp)
- 2. Base bronzo spazzolato (wall lamp)
- 3. Base nickel satinato (wall lamp)
- 4. Maglia d'acciaio intrecciato (wall lamp)
- 5. Pelle avorio
- 6. Pelle marrone testa di moro
- 7. Pelle nera

**Fonte luminosa - Light source**

**220 - 240V:**  
Ap 1 x 3W LED module; 2700 K; CRI: >90  
Fl 1 x 7W LED module; 2700 K; CRI: >90

**FI**  
Dimmerabile a piede  
*Dimmable with foot control*

- 1. Matt black silk lacquered base (floor lamp)
- 2. Satin bronze base (wall lamp)
- 3. Satin nickel base (wall lamp)
- 4. Braided steel mesh (wall lamp)
- 5. Ivory leather
- 6. Dark brown leather
- 7. Black leather

**110V:**  
Ap 1 x 3W LED module; 2700 K; CRI: >90  
Fl 1 x 7W LED module; 2700 K; CRI: >90

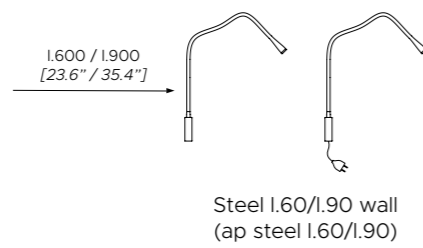
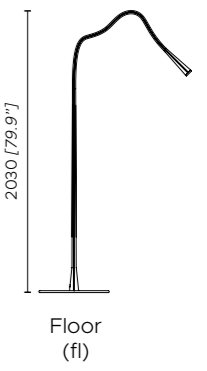



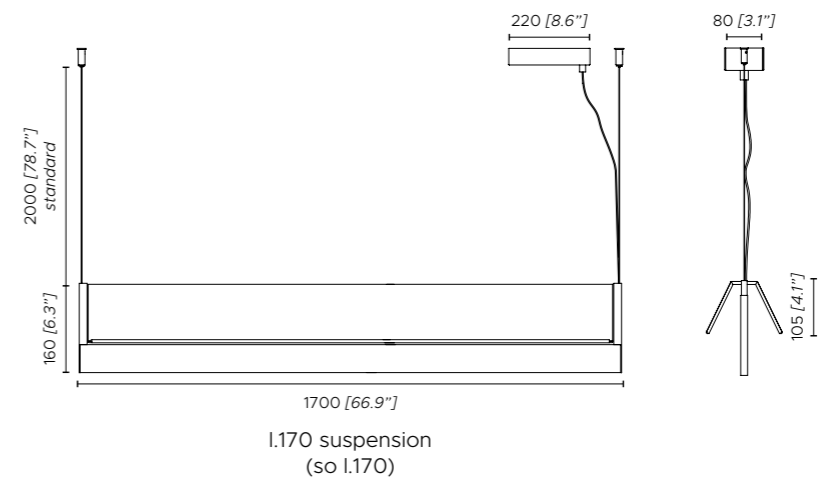
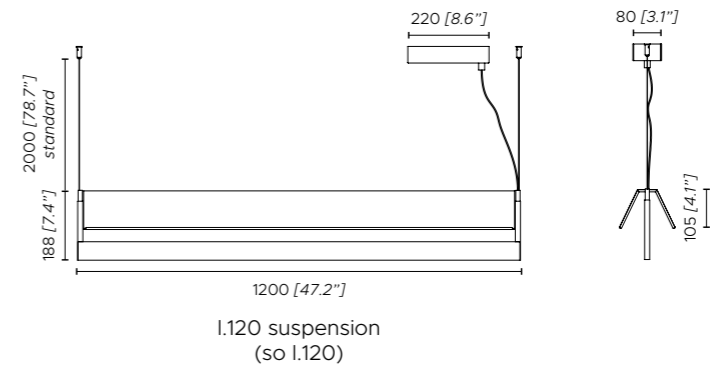
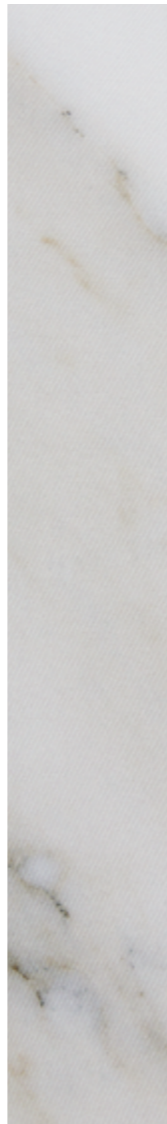

**DOPPIA EMISSIONE:** LUCE DIRETTA E INDIRETTA  
**DOUBLE EMISSION:** DIRECT AND INDIRECT LIGHT



#### Fonte luminosa - Light source

##### **220 - 240V:**

So I.120 superiore/*upper* 1 x 17W Strip LED;  
 inferiore/*lower* 1 x 23W Strip LED; 2700 K; CRI: >90  
 So I.150 superiore/*upper* 1 x 24W Strip LED;  
 inferiore/*lower* 1 x 30W Strip LED; 2700 K; CRI: >90

Dimmerazione a taglio di fase/Triac - altri sistemi  
 di dimmerazione (DALI e 1-10V) disponibili su richiesta  
*Phase cut/Triac dimming - alternative dimming systems*  
 (DALI and 1-10V) available on demand

##### **110V:**

So I.120 superiore/*upper* 1 x 17W Strip LED;  
 inferiore/*lower* 1 x 23W Strip LED; 2700 K; CRI: >90  
 So I.150 superiore/*upper* 1 x 24W Strip LED;  
 inferiore/*lower* 1 x 30W Strip LED; 2700 K; CRI: >90

Dimmerazione a taglio di fase/Triac - dimmerazione  
 1-10V disponibile su richiesta  
*Phase cut/Triac dimming - 1-10V dimming system*  
 available on demand

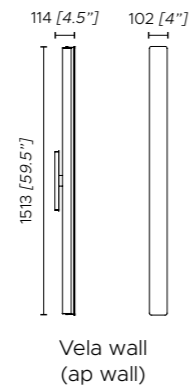
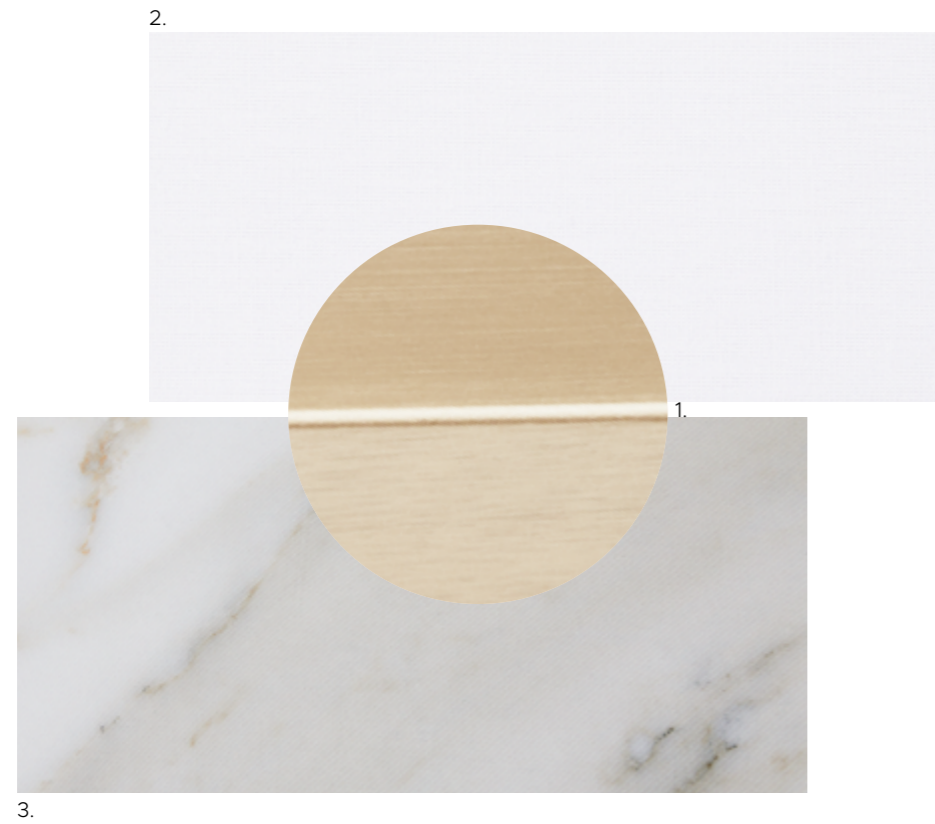

- 1. Struttura nickel dorato satinato
- 2. Cotone bianco
- 3. Tessuto effetto marmo bianco Calacatta

**Fonte luminosa - Light source**

**220 - 240V:**  
Ap - ap vela fronte/front 1 x 20W Strip LED;  
retro/back 1 x 30W Strip LED; 2700 K; CRI: >90

Dimmerazione a taglio di fase/Triac - altri sistemi di dimmerazione (DALI e 1-10V) disponibili su richiesta  
Phase cut/Triac dimming - alternative dimming systems (DALI and 1-10V) available on demand

- 1. Satin golden nickel frame
- 2. White cotton
- 3. White Calacatta marble printed fabric

**110V:**  
Ap - ap vela fronte/front 1 x 20W Strip LED;  
retro/back 1 x 30W Strip LED; 2700 K; CRI: >90

Dimmerazione a taglio di fase/Triac - dimmerazione 1-10V disponibile su richiesta  
Phase cut/Triac dimming - 1-10V dimming system available on demand



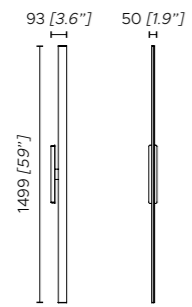

Wall  
(ap)

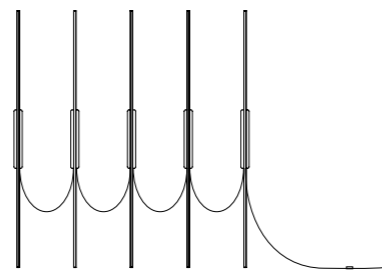

**Composizione** esempio Fly ap (max. 5 lampade) /  
*Example of Fly ap modular system (max. 5 lamps)*





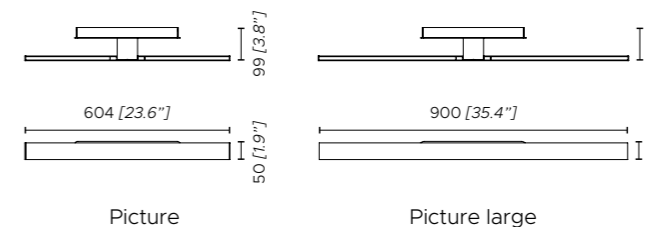
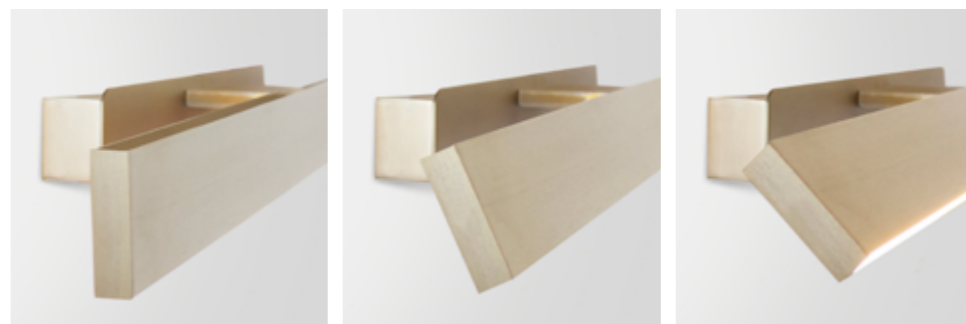

**Fonte luminosa - Light source**

**220 - 240V:**

Picture 1 x 12W Strip LED; 2700 K; CRI: >90  
 Picture large 1 x 18W Strip LED; 2700 K; CRI: >90

Dimmerazione a taglio di fase/Triac - altri sistemi di dimmerazione (DALI e 1-10V) disponibili su richiesta  
 Phase cut/Triac dimming - alternative dimming systems (DALI and 1-10V) available on demand

**110V:**

Picture 1 x 12W Strip LED; 2700 K; CRI: >90  
 Picture large 1 x 18W Strip LED; 2700 K; CRI: >90

Dimmerazione a taglio di fase/Triac - dimmerazione 1-10V disponibile su richiesta  
 Phase cut/Triac dimming - 1-10V dimming system available on demand

G+T

Jan Van Lierde



2000 [78.7"] 80 [3.1"]  
standard  
404 [15.9"]  
50 [1.9"]  
Suspension  
(so)



VERSIONE **CABLATA** / **WIRED VERSION**



**Porta USB** per ricaricare dispositivi elettronici  
**USB port** for charging electronic devices

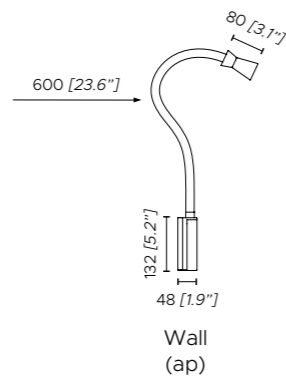

- 1. Laccato nero seta opaco (suspension lamp - reading lamp)
- 2. Bronzo rame lucido
- 3. Nickel lucido

- 4. Pelle intrecciata marrone testa di moro

**Fonte luminosa - Light source**

**220 - 240V:**  
1 x 3W LED module; 2700 K; CRI: >90

**Ap - battery**  
Dimmerabile, comando a tre livelli (100% - 70% - 30%)  
*Dimmable, three levels control (100% - 70% - 30%)*

- 1. Matt black silk lacquered (suspension lamp - reading lamp)
- 2. Polished copper bronze
- 3. Polished nickel

- 4. Dark brown braided leather

**110V:**  
1 x 3W LED module; 2700 K; CRI: >90



VERSIONE **A BATTERIA** / **BATTERY OPERATED VERSION**

FISSAGGIO PER **TAVOLO**

**TABLE** FIXING ACCESSORY

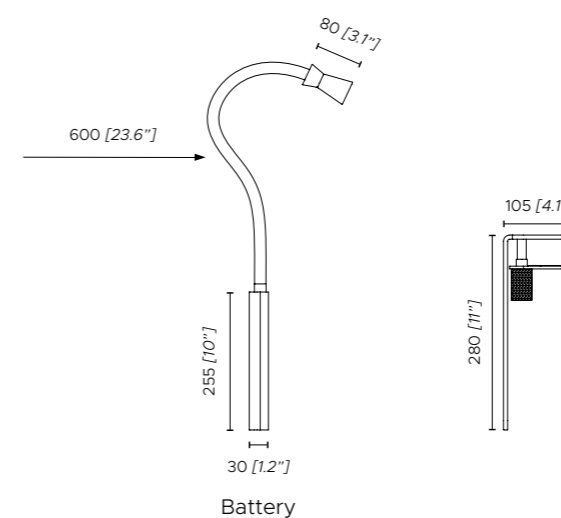

Dimmerabile: 3 intensità (100% - 70% - 30%)  
**Dimmable: 3 steps (100% - 70% - 30%)**

VERSIONE A BATTERIA / BATTERY OPERATED VERSION



FISSAGGIO A PARETE

WALL FIXING ACCESSORY

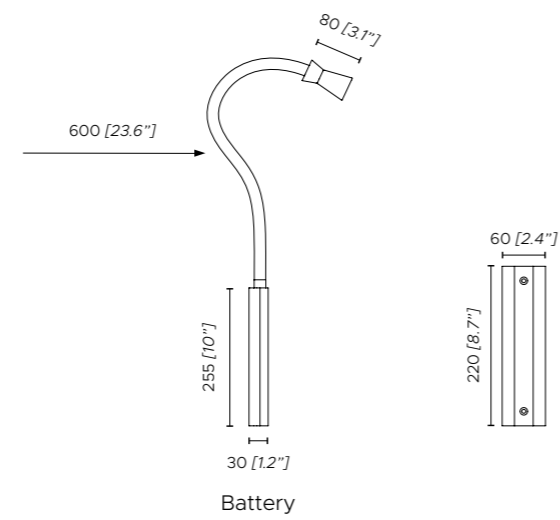

Dimmerabile: 3 intensità (100% - 70% - 30%)  
**Dimmable: 3 steps (100% - 70% - 30%)**





VERSIONE A BATTERIA / BATTERY OPERATED VERSION

FISSAGGIO PER POLTRONE E DIVANI

SEATS & SOFAS FIXING ACCESSORY

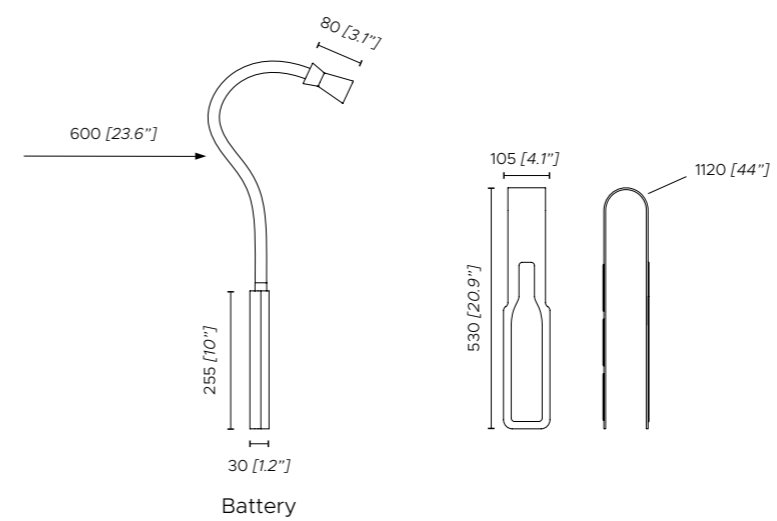

Dimmerabile: 3 intensità (100% - 70% - 30%)  
**Dimmable: 3 steps (100% - 70% - 30%)**

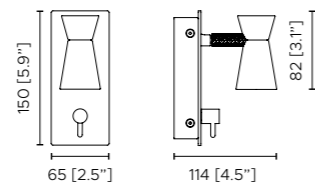

Reading





**Kubric**  
Massimiliano Raggi



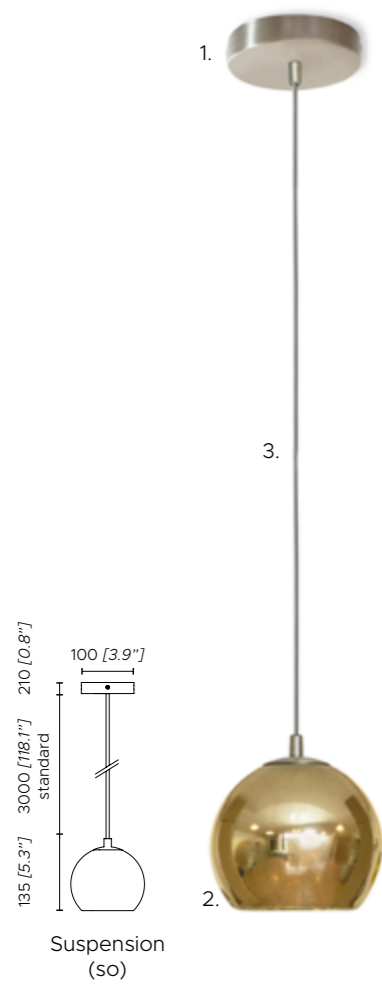

- 1. Struttura nickel dorato satinato
- 2. Vetro bronzo lucido con interno oro
- 3. Cavo tessuto color sabbia

*Altri colori su richiesta*

**Fonte luminosa - Light source**

**220 - 240V:**  
1 x 5W LED module; 2700 K; CRI: >90

Dimmerazione a taglio di fase/Triac  
*Phase cut/Triac dimming*

- 1. Satin golden nickel frame
- 2. Polished bronze glass with gold painted inside
- 3. Sand colour fabric cable

*Other colours available on demand*

**110V:**  
1 x 5W LED module; 2700 K; CRI: >90

Dimmerazione a taglio di fase/Triac - dimmerazione 1-10V disponibile su richiesta  
*Phase cut/Triac dimming - 1-10V dimming system available on demand*

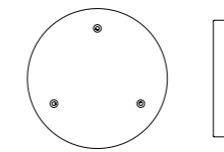

**Cluster Ø300 mm**  
3 sospensioni  
3 suspensions

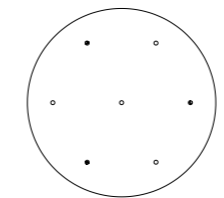

**Cluster Ø500 mm**  
7 sospensioni  
7 suspensions

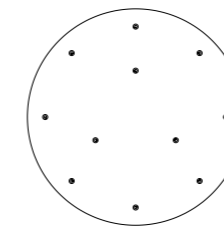

**Cluster Ø700 mm**  
11 sospensioni  
11 suspensions

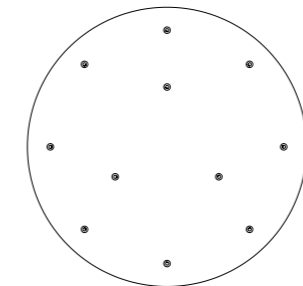

**Cluster Ø900 mm**  
22 sospensioni  
22 suspensions

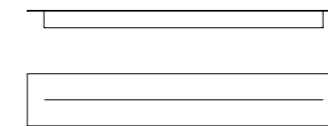

**Cluster L.900 mm**  
Fino a 6 sospensioni  
Up to 6 suspensions

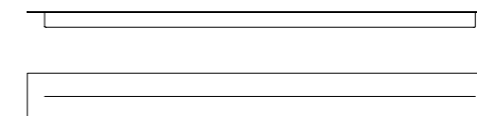

**Cluster L.1500 mm**  
Fino a 10 sospensioni  
Up to 10 suspensions

*Altre composizioni su richiesta*  
*Other compositions available on demand*

# Manhattan

Contardi Studio



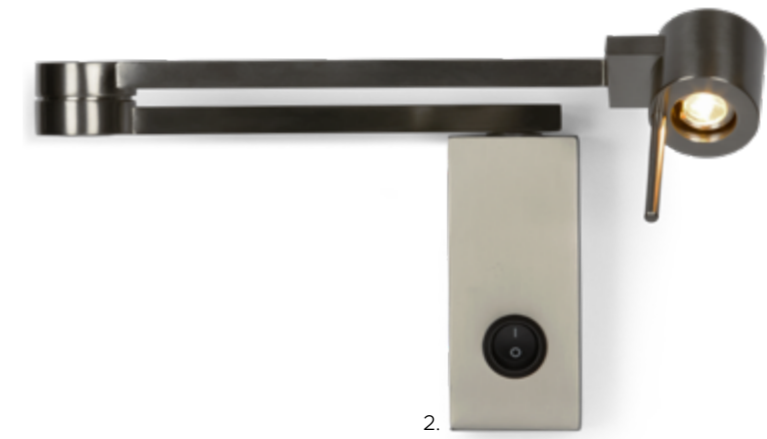
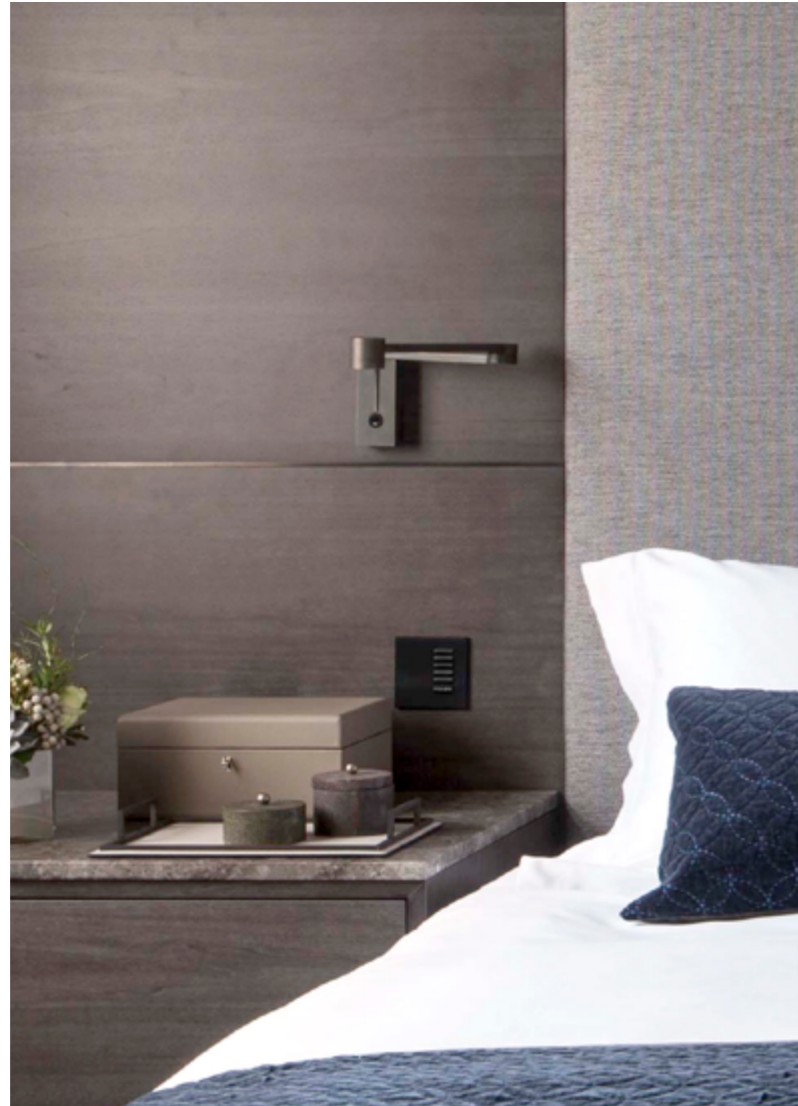

2.

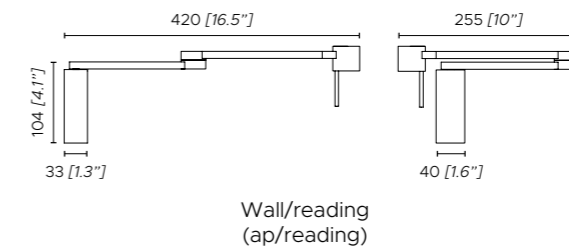

Wall/reading  
(ap/reading)



APRI / **OPEN**

RUOTA / **TURN**

CHIUDI / **CLOSE**

1.

- 1. Bronzo spazzolato
- 2. Nickel satinato

- 1. Satin bronze
- 2. Satin nickel

**Fonte luminosa - Light source**

**220 - 240V:**  
1 x 3W LED module; 2700 K; CRI: >90

**110V:**  
1 x 3W LED module; 2700 K; CRI: >90



# Melanocetus

Tristan Auer

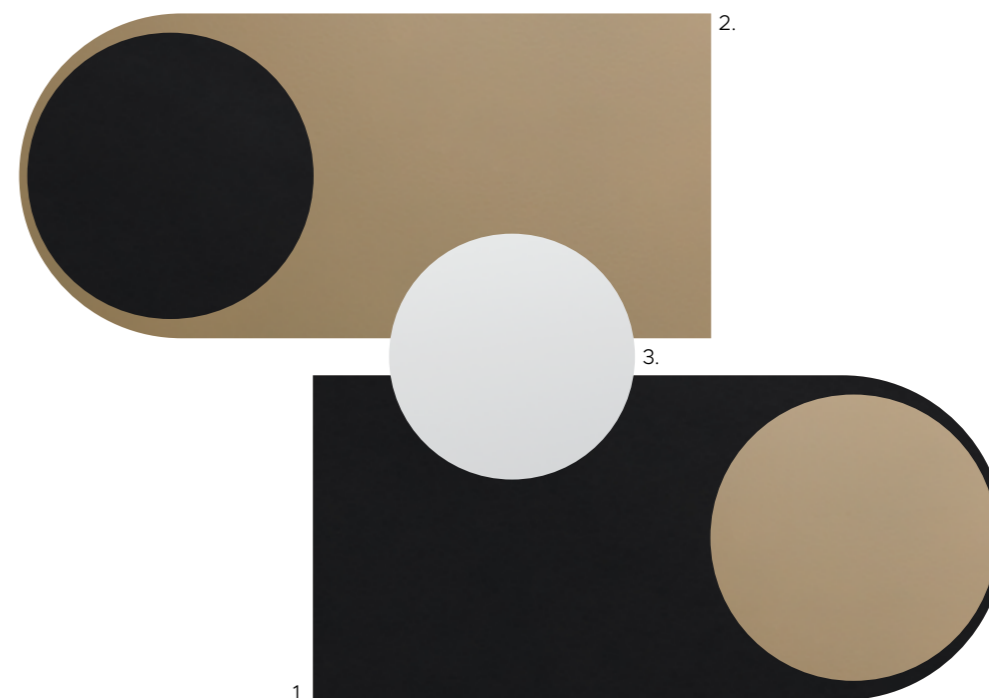

1. Nero opaco con dettagli oro satinato  
2. Oro satinato con dettagli nero opaco

3. Diffusore: plexiglass satinato

**Fonte luminosa - Light source**

**220 - 240V:**  
PI 2 x 7.5W GU10 LED dimmerabile - *dimnable*;  
3000 K; CRI: >90  
PI double 4 x 7.5W GU10 LED dimmerabile -  
*dimnable*; 3000 K; CRI: >90

1. Matt black lacquered with satin gold details  
2. Satin gold with matt black lacquered details

3. Diffuser: satin plexiglass

**110V:**  
PI 2 x 7.5W GU10 LED dimmerabile - *dimnable*;  
3000 K; CRI: >90  
PI double 4 x 7.5W GU10 LED dimmerabile -  
*dimnable*; 3000 K; CRI: >90

Compatibile con sistemi di controllo remoto in caso di utilizzo di lampadine LED dimmerabili  
*Compatible with remote control systems when dimmable LED bulbs are used*

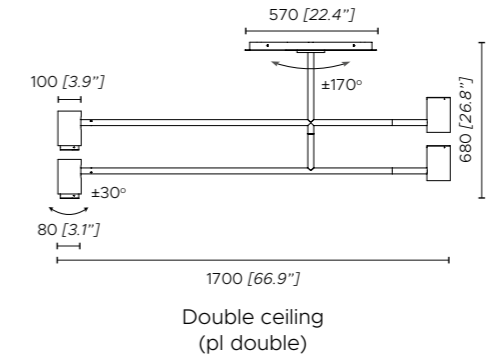
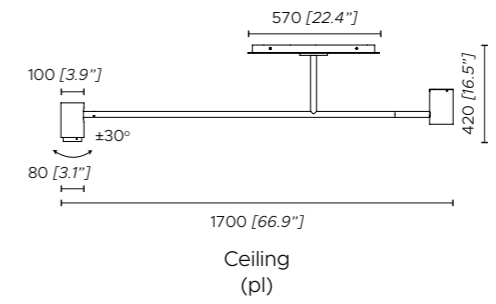

# Mikado

Massimiliano Raggi





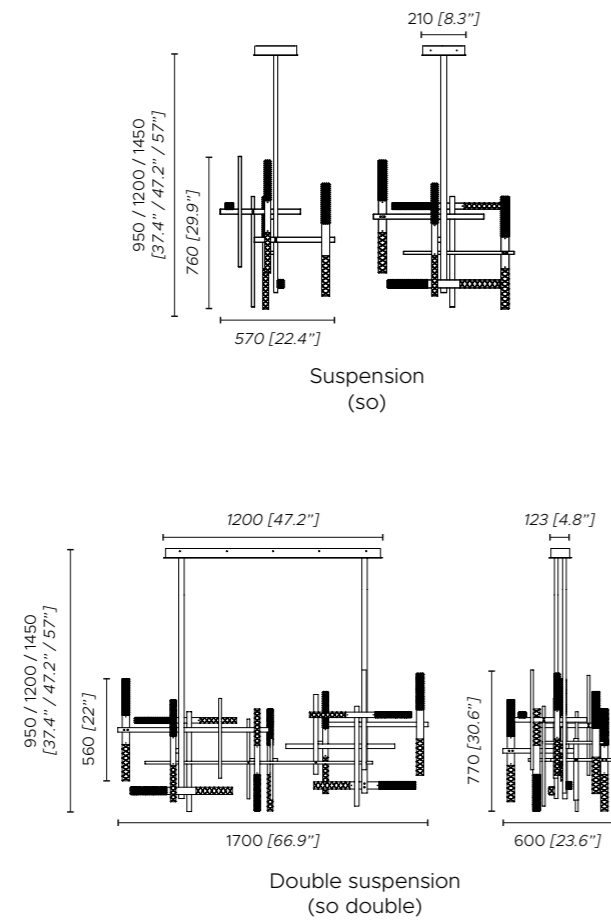

#### Fonte luminosa - Light source

##### 220 - 240V:

So 10 x 4W LED module; 3000 K; CRI: >90  
So double 20 x 4W LED module; 3000 K; CRI: >90

Dimmerazione a taglio di fase/Triac - altri sistemi di dimmerazione (DALI e 1-10V) disponibili su richiesta  
*Phase cut/Triac dimming - alternative dimming systems (DALI and 1-10V) available on demand*

##### 110V:

So 10 x 4W LED module; 3000 K; CRI: >90  
So double 20 x 4W LED module; 3000 K; CRI: >90

Dimmerazione a taglio di fase/Triac - dimmerazione 1-10V disponibile su richiesta  
*Phase cut/Triac dimming - 1-10V dimming system available on demand*



1.



3.



2.

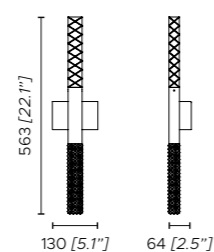

Wall solo/2  
(ap solo/2)

- 1. Ottone satinato
- 2. Cristallo trasparente inciso
- 3. Cristallo trasparente prismatic

**Fonte luminosa - Light source**

**220 - 240V:**  
Ap solo/2 2 x 4W LED module; 3000 K; CRI: >90

Dimmerazione a taglio di fase/Triac - altri sistemi di dimmerazione (DALI e 1-10V) disponibili su richiesta  
*Phase cut/Triac dimming - alternative dimming systems (DALI and 1-10V) available on demand*

- 1. Satin brass
- 2. Transparent engraved crystal diffuser
- 3. Transparent prismatic crystal diffuser

**110V:**  
Ap solo/2 2 x 4W LED module; 3000 K; CRI: >90

Dimmerazione a taglio di fase/Triac - dimmerazione 1-10V disponibile su richiesta  
*Phase cut/Triac dimming - 1-10V dimming system available on demand*

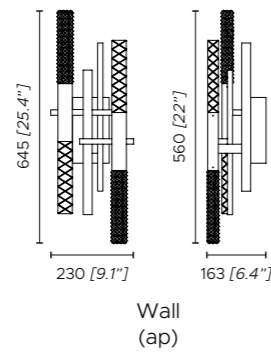
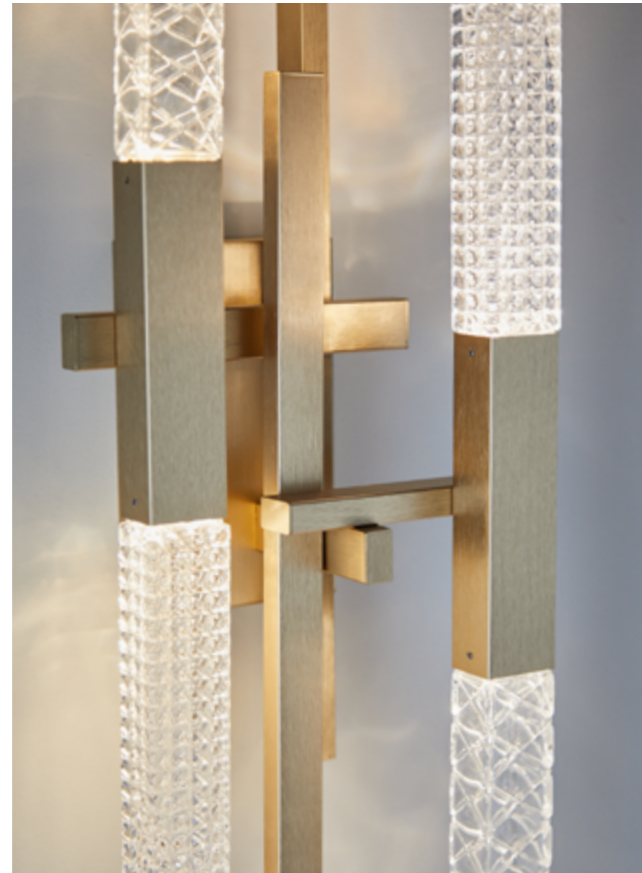

**Fonte luminosa - Light source**

**220 - 240V:**  
Ap 4 x 4W LED module; 3000 K; CRI: >90

Dimmerazione a taglio di fase/Triac - altri sistemi di dimmerazione (DALI e 1-10V) disponibili su richiesta  
*Phase cut/Triac dimming - alternative dimming systems (DALI and 1-10V) available on demand*

**110V:**  
Ap 4 x 4W LED module; 3000 K; CRI: >90

Dimmerazione a taglio di fase/Triac - dimmerazione 1-10V disponibile su richiesta  
*Phase cut/Triac dimming - 1-10V dimming system available on demand*

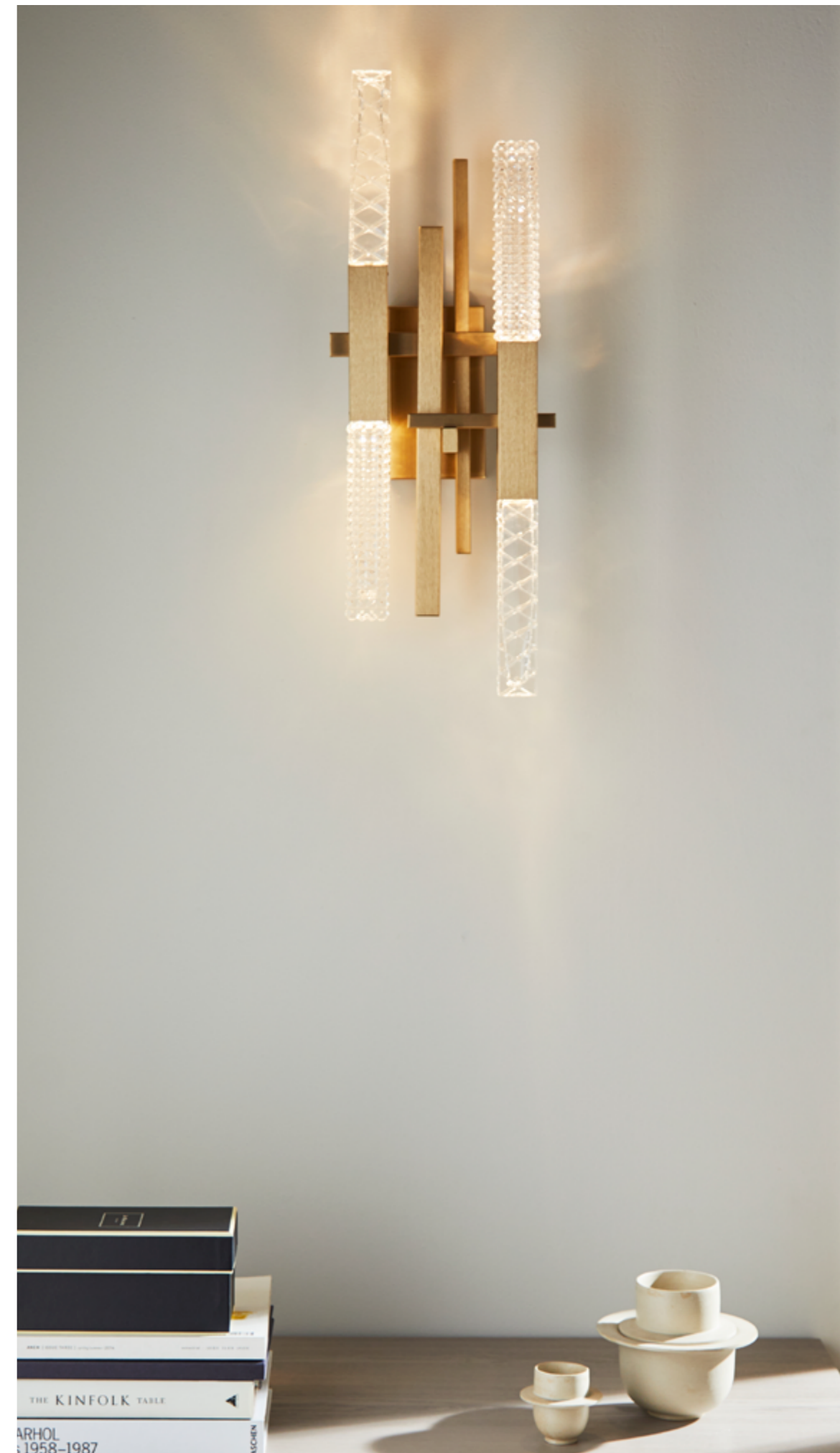

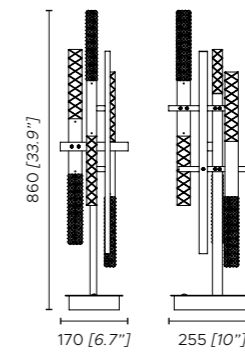

Table  
(ta)

**Fonte luminosa - Light source**

**220 - 240V:**  
Ta 6 x 4W LED module; 3000 K; CRI: >90

**110V:**  
Ta 6 x 4W LED module; 3000 K; CRI: >90

Dimmerabile su base a tre livelli d'intensità (100% - 70% - 30%)  
*Dimmable with three intensity levels on the base (100% - 70% - 30%)*

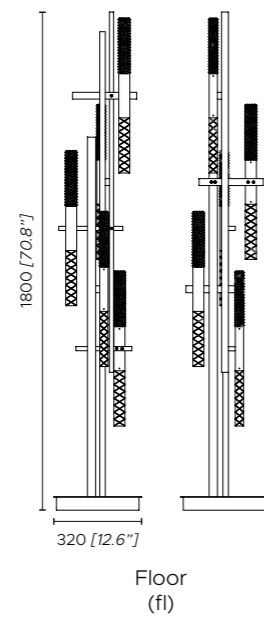

**Fonte luminosa - Light source**

**220 - 240V:**  
FI 10 x 4W LED module; 3000 K; CRI: >90

**110V:**  
FI 10 x 4W LED module; 3000 K; CRI: >90

Dimmerabile a piede  
*Dimmable with foot control*

# Muse Lantern

Tristan Auer





- 1. Struttura bronzo spazzolato
- 2. Maniglia in seta intrecciata color miele
- 3. Diffusore acrilico color ambra

- 1. Satin bronze frame
- 2. Honey-coloured braided silk handle
- 3. Amber acrylic diffuser

**Fonte luminosa - Light source**

**220 - 240V:**  
1 x 10W E27 Classic Deco LED

**110V:**  
1 x 10W E26 Classic Deco LED

Disponibile su richiesta versione con dimmer a piede, compatibile solo con lampadine LED dimmerabili  
*Foot dimmer available on demand, compatible with dimmable LED light bulbs only*

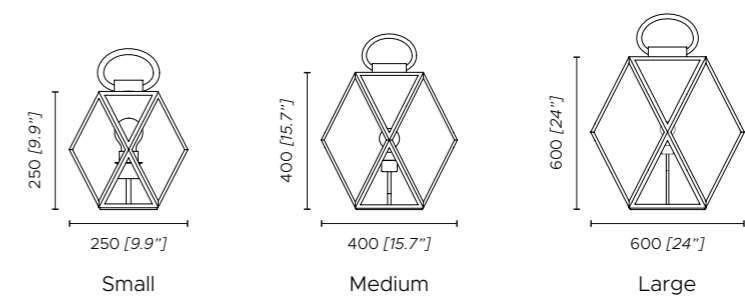

**Ongo**  
Jessica Corr for Tzelan





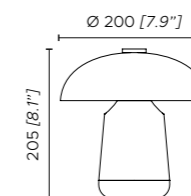

- 1. Laccato arancione scuro
- 2. Laccato oro satinato
- 3. Laccato nickel caldo

- 1. Dark orange lacquered
- 2. Satin gold lacquered
- 3. Warm nickel lacquered

**Fonte luminosa - Light source**

**220 - 240V:**  
1 x 3.5W LED module; 2800 K; CRI: >90

**110V:**  
1 x 3.5W LED module; 2800 K; CRI: >90

Dimmerabile, due intensità  
*Dimmable, two intensity levels*

# Solitario

Marcello Colli & Maurizio Di Mauro





1. Bronzo spazzolato chiaro opaco  
2. Laccato nero seta opaco

3. Sfera vetro acidato ø 120 / 4.7"  
4. Sfera vetro acidato ø 200 / 7.9"  
5. Lente flood

#### Fonte luminosa - Light source

**220 - 240V:**  
PI - So 1 x 7.5W GU10 LED dimmerabile - *dimnable*;  
3000 K; CRI: >90  
Ap mini 1 x 7W E27 T8 LED  
Ap mini IP44 1 x 5W G9 LED

1. Matt light satin bronze  
2. Matt black silk lacquered

3. Acid-etched glass sphere ø 120 / 4.7"  
4. Acid-etched glass sphere ø 200 / 7.9"  
5. Flood lens

**110V:**  
PI - So 1 x 7.5W GU10 LED dimmerabile - *dimnable*;  
3000 K; CRI: >90  
Ap mini 1 x 7W E26 T8 LED  
Ap mini IP44 1 x 5W G9 LED

Compatibile con sistemi di controllo remoto in caso di utilizzo di lampadine LED dimmerabili  
*Compatible with remote control systems when dimmable LED bulbs are used*

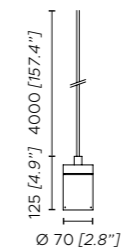

Suspension  
(so)



## Composizioni / Compositions

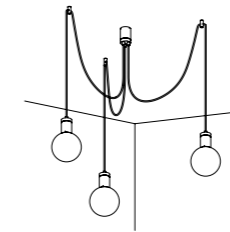

- 1 x Rosone 3x / Canopy 3x
- 3 x Solitario So
- 3 x Kit accessori / Accessories  
(Carrucola / Blocca cavo)  
(Pulley / Cable clamp)
- 3 x Sfere Ø 200 / Spheres Ø 200 / Ø 7,9"

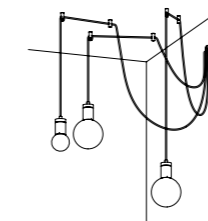

- 1 x Rosone 3x / Canopy 3x
- 3 x Solitario So
- 6 x Kit accessori / Accessories  
(Carrucola / Blocca cavo)  
(Pulley / Cable clamp)
- 1 x Sfera Ø 120 / Sphere Ø 120 / Ø 4,7"
- 2 x Sfere Ø 200 / Spheres Ø 200 / Ø 7,9"

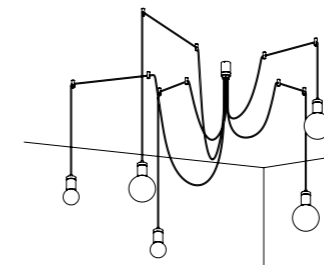

- 1 x Rosone 5x / Canopy 5x
- 5 x Solitario So
- 10 x Kit accessori / Accessories  
(Carrucola / Blocca cavo)  
(Pulley / Cable clamp)
- 2 x Sfere Ø 120 / Spheres Ø 120 / Ø 4,7"
- 3 x Sfere Ø 200 / Spheres Ø 200 / Ø 7,9"

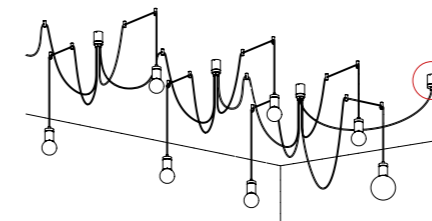

Una sola uscita elettrica per composizioni potenzialmente infinite

Just one electrical output for potentially unlimited compositions

### Rosone / Canopy

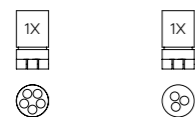

- 1 x rosone 5x / 1 x canopy 5x
- 1 x rosone 3x / 1 x canopy 3x

### Sfere / Spheres



- 3 x Ø 200 / 4,7"
- 5 x Ø 120 / 7,8"

### 8 x Solitario So

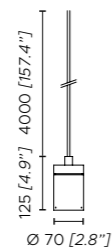

### Accessori / Accessories

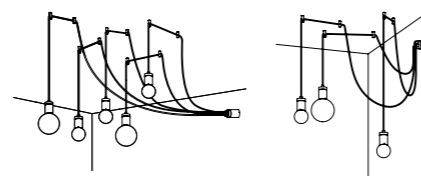
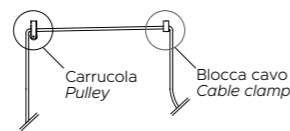

Composizione 5x / Composition 5x

Composizione 3x / Composition 3x

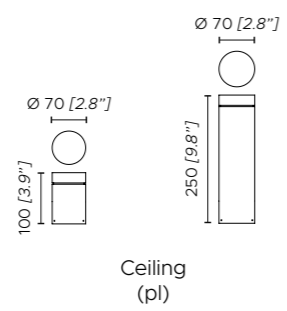

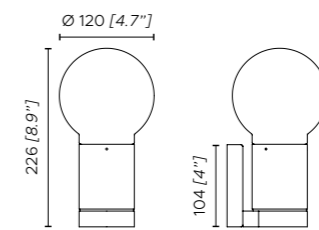

Mini wall/mini IP44 wall  
(ap mini/ap mini IP44)

# Stardust

Marcello Colli & Maurizio Di Mauro





1. Bronzo spazzolato chiaro opaco

2. Vetro bianco satinato

**Fonte luminosa - Light source**

**220 - 240V:**  
1 x 14W E27 LED + 20 x 2W LED module;  
2700 K; CRI: >90

1. Matt light satin bronze

2. Satin white glass

**110V:**  
1 x 14W E26 LED + 20 x 2W LED module;  
2700 K; CRI: >90

Fonte luminosa principale compatibile con sistemi di controllo remoto in caso di utilizzo di lampadine LED dimmerabili  
Modulo LED, posizionati sui bracci non sono dimmerabili  
Main light source compatible with remote control systems when dimmable LED bulbs are used  
LED module located on arms are not dimmable

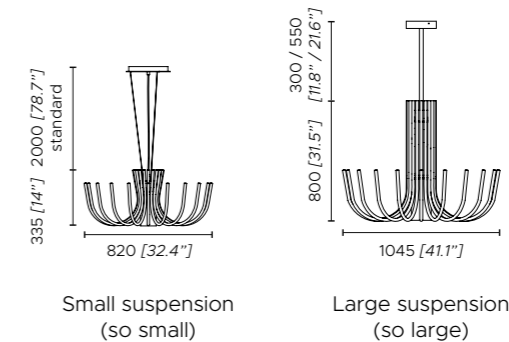



**Stick**  
Studiopepe



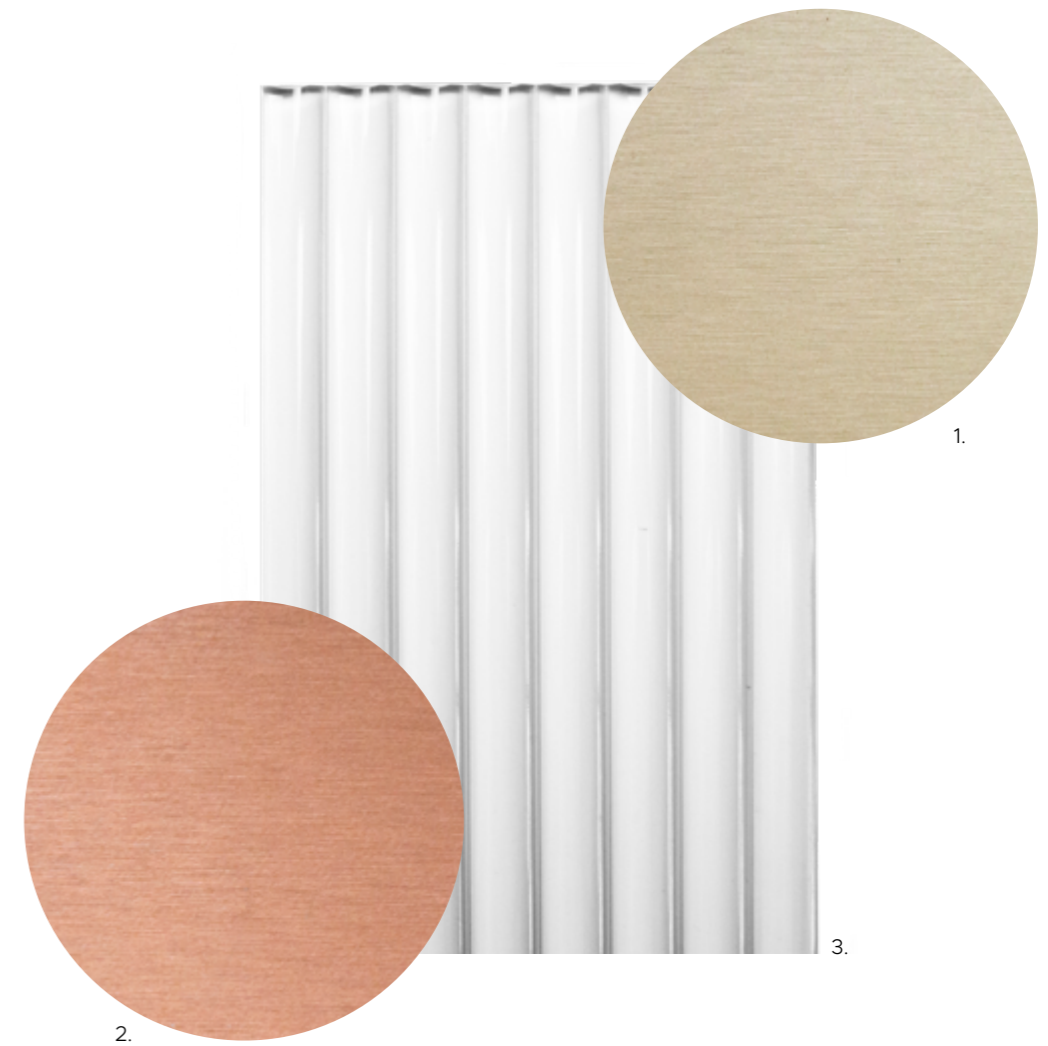
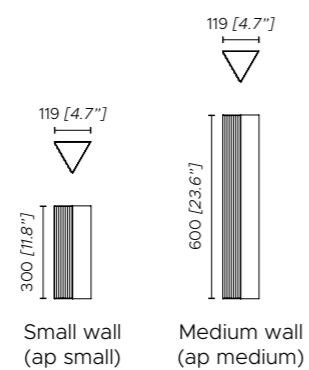

- 1. Struttura nickel dorato satinato
- 2. Struttura rame satinato
- 3. Diffusore plexiglass rigato

*Altre finiture disponibili su richiesta*

**Fonte luminosa - Light source**

**220 - 240V:**  
**Ap small** 1 x 13.5W Custom LED; 2700 K; CRI: >90  
**Ap medium** 1 x 27W Custom LED; 2700 K; CRI: >90

Dimmerazione a taglio di fase/Triac - altri sistemi di dimmerazione (DALI e 1-10V) disponibili su richiesta  
*Phase cut/Triac dimming - alternative dimming systems (DALI and 1-10V) available on demand*

- 1. Satin golden nickel frame
- 2. Satin copper frame
- 3. Striped plexiglass diffuser

*Other finishes available on demand*

**110V:**  
**Ap small** 1 x 13.5W Custom LED; 2700 K; CRI: >90  
**Ap medium** 1 x 27W Custom LED; 2700 K; CRI: >90

Dimmerazione a taglio di fase/Triac - dimmerazione 1-10V disponibile su richiesta  
*Phase cut/Triac dimming - 1-10V dimming system available on demand*

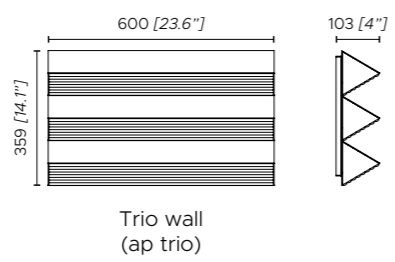

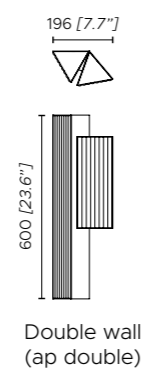

**Fonte luminosa - Light source**

**220 - 240V:**  
**Ap double** 1 x 13.5W Custom LED + 1 x 27W Custom LED;  
 2700 K; CRI: >90  
**Ap trio** 3 x 27W Custom LED; 2700 K; CRI: >90

Dimmerazione a taglio di fase/Triac - altri sistemi  
 di dimmerazione (DALI e 1-10V) disponibili su richiesta  
*Phase cut/Triac dimming - alternative dimming systems*  
 (DALI and 1-10V) available on demand

**110V:**  
**Ap double** 1 x 13.5W Custom LED + 1 x 27W Custom LED;  
 2700 K; CRI: >90  
**Ap trio** 3 x 27W Custom LED; 2700 K; CRI: >90

Dimmerazione a taglio di fase/Triac - dimmerazione  
 1-10V disponibile su richiesta  
*Phase cut/Triac dimming - 1-10V dimming system*  
 available on demand

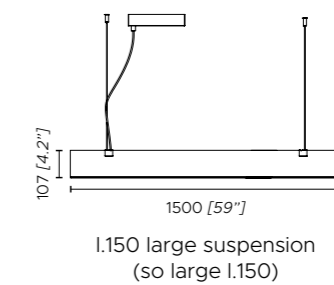
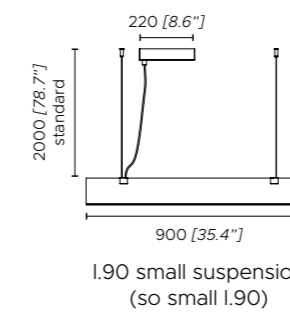

**Fonte luminosa - Light source**

**220 - 240V:**  
**So small I.90** 1 x 40W Custom LED; 2700 K; CRI: >90  
**So large I.150** 1 x 65W Custom LED; 2700 K; CRI: >90

Dimmerazione a taglio di fase/Triac - altri sistemi di dimmerazione (DALI e 1-10V) disponibili su richiesta  
*Phase cut/Triac dimming - alternative dimming systems (DALI and 1-10V) available on demand*

**110V:**  
**So small I.90** 1 x 40W Custom LED; 2700 K; CRI: >90  
**So large I.150** 1 x 65W Custom LED; 2700 K; CRI: >90

Dimmerazione a taglio di fase/Triac - dimmerazione 1-10V disponibile su richiesta  
*Phase cut/Triac dimming - 1-10V dimming system available on demand*

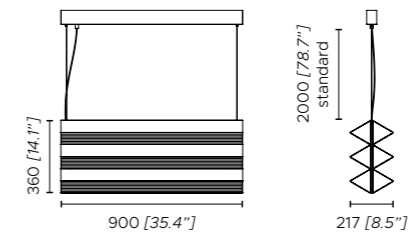

Trio suspension  
(so trio)

**Fonte luminosa - Light source**

**220 - 240V:**

So trio 6 x 40W Custom LED; 2700 K; CRI: >90

Dimmerazione a taglio di fase/Triac - altri sistemi di dimmerazione (DALI e 1-10V) disponibili su richiesta  
*Phase cut/Triac dimming - alternative dimming systems (DALI and 1-10V) available on demand*

**110V:**

So trio 6 x 40W Custom LED; 2700 K; CRI: >90

Dimmerazione a taglio di fase/Triac - dimmerazione 1-10V disponibile su richiesta  
*Phase cut/Triac dimming - 1-10V dimming system available on demand*

# Tenebra

Jan Van Lierde



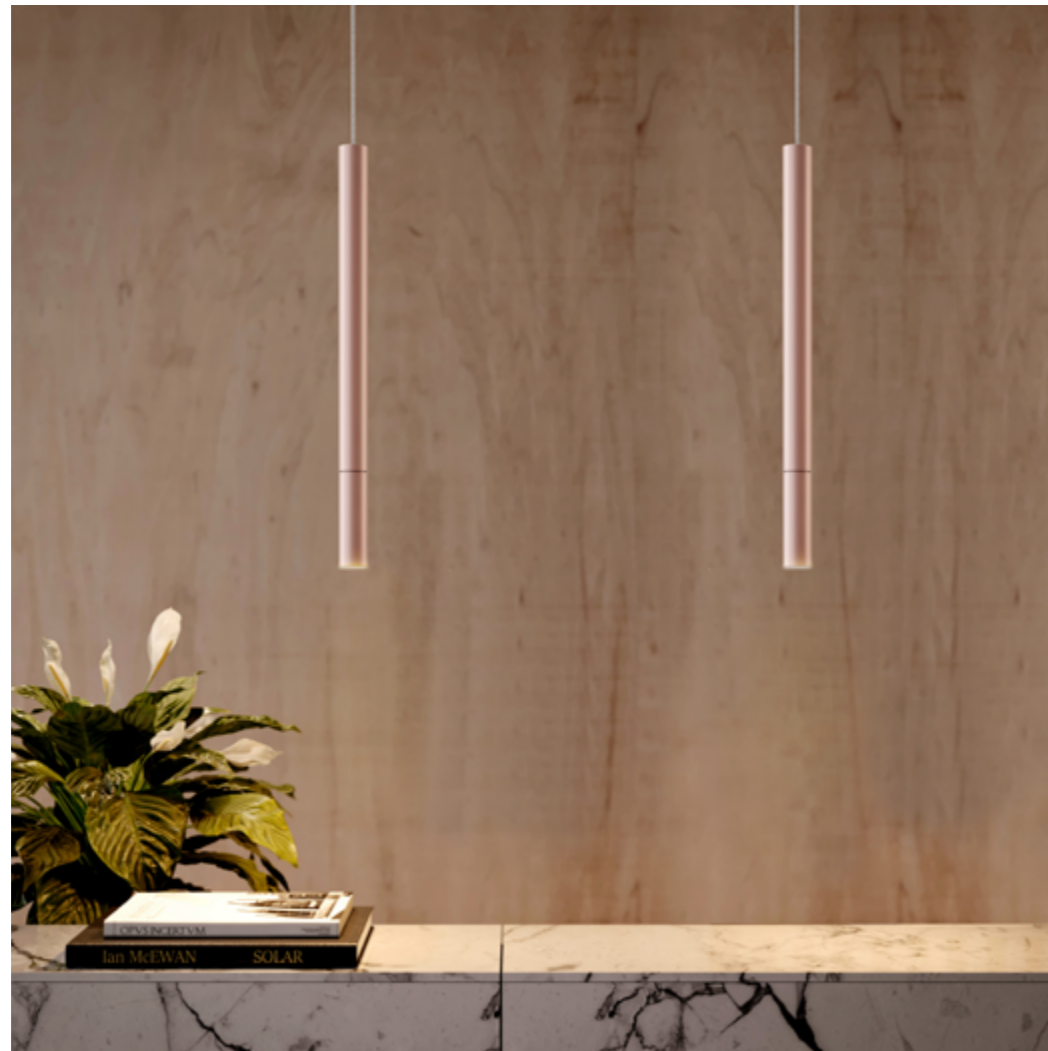

VERSIONE A BATTERIA,  
SENZA ROSONE  
**BATTERY OPERATED  
VERSION, WITHOUT CANOPY**

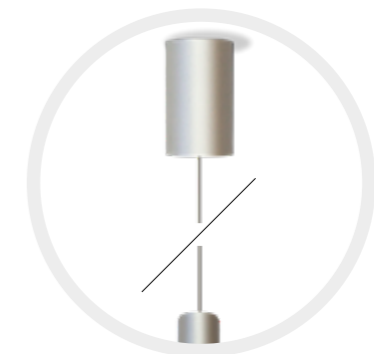

VERSIONE CABLATA,  
CON ROSONE  
**WIRED VERSION,  
WITH CANOPY**

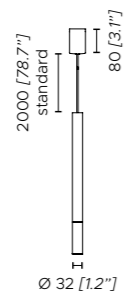

Suspension  
(so)

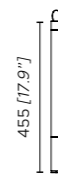

Battery suspension  
(so battery)

1. Laccato argento
2. Laccato oro rosa
3. Laccato nero opaco

**Fonte luminosa - Light source**

**220 - 240V:**  
1 x 3W LED module; 2700 K; CRI: >90

IP65

**Batteria/battery**  
Dimmerabile  
*Dimmable*

1. Silver lacquered
2. Rose gold lacquered
3. Matt black lacquered

**110V:**  
1 x 3W LED module; 2700 K; CRI: >90

IP65



ACCESSORI TENEBRA / TENEBRA ACCESSORIES

DIFFUSORI PER VERSIONE CABLATA E A BATTERIA

WIRED & BATTERY OPERATED DIFFUSERS



1.



2.



3.

- 1. Diffusore cristallo sintetico, Venezia ambra
- 2. Diffusore cristallo sintetico, Lente grigio
- 3. Diffusore cristallo sintetico, Crystal Macedonia

- 1. Diffuser synthetic crystal, Venezia Amber
- 2. Diffuser synthetic crystal, Grey lens
- 3. Diffuser synthetic crystal, Crystal Macedonia

ACCESSORI DI FISSAGGIO

PER VERSIONE A BATTERIA (inclusi)

BATTERY OPERATED HANGING ACCESSORIES (included)



Accessori di fissaggio (inclusi)

- 1 x staffa per attacco a soffitti + 1 x griplock + 1 x bloccacavo + 1 x cavo in acciaio l. 2m + 1 x gancio standard

Hanging accessories (included)

- 1 x ceiling attachment + 1 x griplock + 1 x screw lock + 1 x steel cable l. 2m + 1 x standard hook

Accessori versione a batteria (non inclusi) / Battery operated version accessories (not included)

- ACCESSORI "A" (non inclusi)  
1 x cavo in acciaio l. 2m + 1 x gancio design
- "A" ACCESSORIES (not included)  
1 x steel cable l. 2m + 1 x design hook

- ACCESSORI "B" (non inclusi)  
1 x tirante + 2 x bloccacavo + 1 x cavo in acciaio l. 10m + 6 x griplock
- "B" ACCESSORIES (not included)  
1 x tie rod + 2 x screw lock + 1 x steel cable l. 10m + 6 x griplock

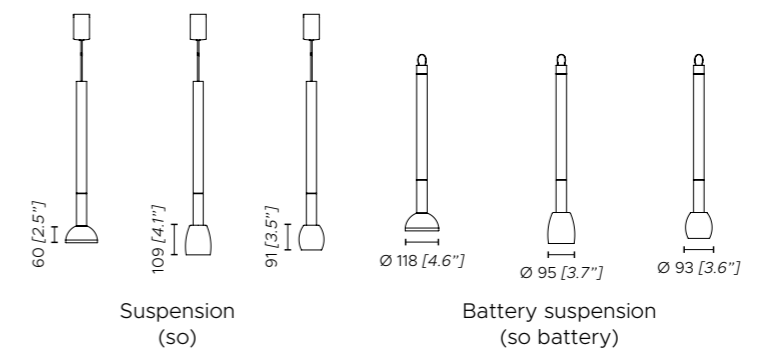

Up

Massimiliano Raggi



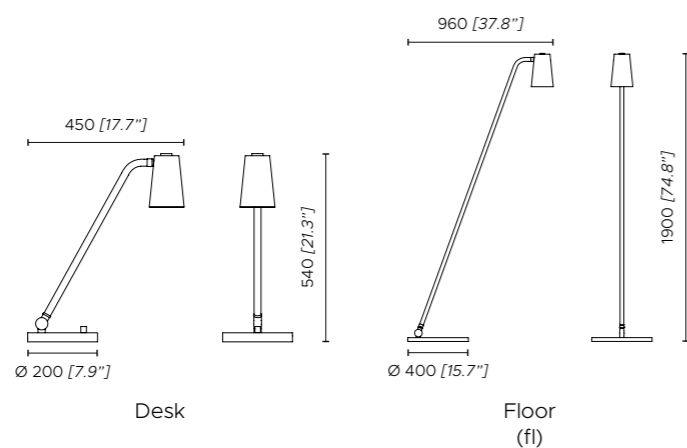

1. Struttura bronzo-nickel spazzolato
2. Cavo in seta color arancione scuro
3. Diffusore esterno: bronzo-nickel spazzolato
4. Diffusore interno: crema lucido

1. Brushed bronze-nickel frame
2. Dark orange silk rope
3. Outside diffuser: brushed bronze-nickel
4. Inside diffuser: polished cream

#### Fonte luminosa - Light source

**220 - 240V:**  
 Ap 1 x 5W E27 LED  
 Desk 1 x 10W E27 LED  
 Fl 1 x 14W E27 LED

**110V:**  
 Ap 1 x 5W E26 LED  
 Desk 1 x 10W E26 LED  
 Fl 1 x 14W E26 LED

#### Desk - ap

Interruttore rotativo ON-OFF su base  
 Rotary ON-OFF switch on the base

#### Fl

Disponibile su richiesta versione con dimmer a piede, compatibile solo con lampadine LED dimmerabili  
 Foot dimmer available on demand, compatible with dimmable LED light bulbs only

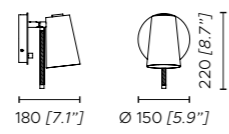

Wall  
(ap)

# Vegas

Massimiliano Raggi



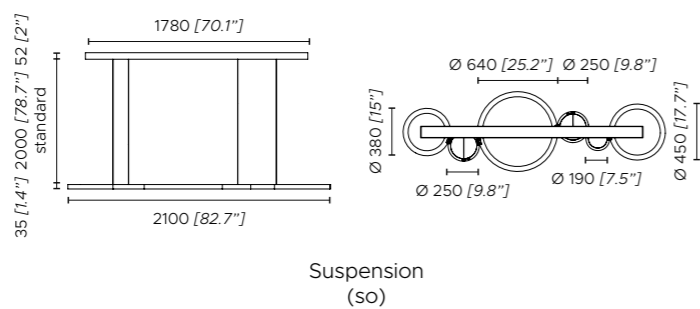

- 1. Rosone bronzo spazzolato
- 2. Anelli grandi in legno bronzo scuro
- 3. Anelli piccoli in legno bronzo chiaro
- 4. Dischi diffusori in alicrite effetto alabastro

- 1. Satin bronze canopy
- 2. Larger rings dark bronze painted wood
- 3. Smaller rings in light bronze painted wood
- 4. Alabaster effect alicrite discs diffusers

**Fonte luminosa - Light source**

**220 - 240V:**  
 3 x 12W COB LED + 1 x 8W Panel LED  
 + 2 x 10W Panel LED; 2700 K; CRI: >90

**110V:**  
 3 x 12W COB LED + 1 x 8W Panel LED  
 + 2 x 10W Panel LED; 2700 K; CRI: >90

Dimmerazione a taglio di fase/Triac - altri sistemi di dimmerazione (DALI e 1-10V) disponibili su richiesta  
*Phase cut/Triac dimming - alternative dimming systems (DALI and 1-10V) available on demand*

Dimmerazione a taglio di fase/Triac - dimmerazione 1-10V disponibile su richiesta  
*Phase cut/Triac dimming - 1-10V dimming system available on demand*



**Sartoria  
Tailoring**

# Athena

Massimiliano Raggi





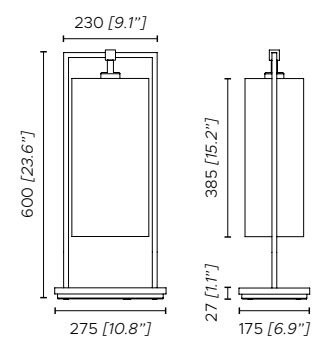

Table  
(ta)

### Struttura / Frame



1.



2.

1. Nickel lucido / *Polished nickel*  
2. Rovere tinto marrone scuro / *Dark brown stained oak*

### Paralume / Shade



1.

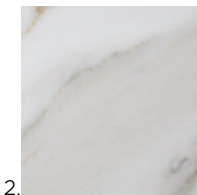

2.

1. Cotone bianco / *White cotton*  
2. Tessuto effetto marmo bianco Calacatta / *White Calacatta marble printed fabric*

### Fonte luminosa - Light source

**220 - 240V:**  
1 x 13W E27 LED

**110V:**  
1 x 13W E26 LED

Disponibile su richiesta versione con dimmer su cavo, compatibile solo con lampadine LED dimmerabili  
*Dimmer switch on the cable available on demand, compatible with dimmable LED light bulbs only*

# Circus & Circus led

Contardi Studio





### Struttura / Frame



Laccato bianco / White lacquered

### Paralume / Shade

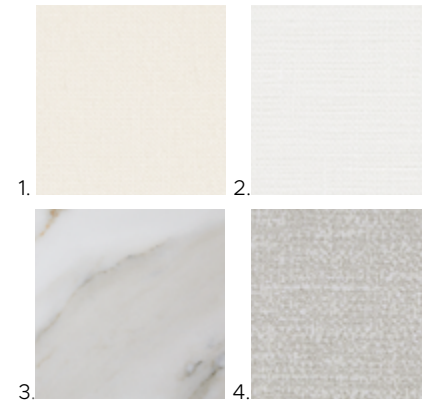

1. Cotone bianco / White cotton
2. Lino bianco / White linen
3. Tessuto effetto marmo bianco Calacatta / White Calacatta marble printed fabric
4. Bouclé color sabbia / Sand colour bouclé

*Altri tessuti sono disponibili su richiesta  
Other fabrics available on demand*

### Passamaneria opzionale / Optional trim



- |                         |                          |
|-------------------------|--------------------------|
| 1. Senape / Mustard     | 1. Blu scuro / Dark blue |
| 2. Rosso / Red          | 2. Grigio / Grey         |
| 3. Azzurro / Light blue | 6. Nero / Black          |

*Altri colori di passamanerie sono disponibili su richiesta  
Other trim colours available on demand*

### Fonte luminosa Circus - Circus light source

#### 220 - 240V:

50 - 75 3 x 14W E27 LED  
90 - 120 - 150 4 x 14W E27 LED

#### 110V:

50-75 3 x 14W E26 LED  
90 - 120 - 150 4 x 14W E26 LED

Compatibile con sistemi di controllo remoto in caso di utilizzo di lampadine LED dimmerabili  
Compatible with remote control systems when dimmable LED bulbs are used

### Fonte luminosa Circus LED - Circus LED light source

#### 220 - 240V:

50 - 75 1 x 53W LED custom board;  
3000 K; CRI: >90  
90 - 120 - 150 1 x 70W LED custom board;  
3000 K; CRI: >90

Dimmerazione a taglio di fase/Triac - altri sistemi di dimmerazione (DALI e 1-10V) disponibili su richiesta  
Phase cut/Triac dimming - alternative dimming systems (DALI and 1-10V) available on demand

#### 110V:

50 - 75 1 x 53W LED custom board;  
3000 K; CRI: >90  
90 - 120 - 150 1 x 70W LED custom board;  
3000 K; CRI: >90

Dimmerazione a taglio di fase/Triac - dimmerazione 1-10V disponibile su richiesta  
Phase cut/Triac dimming - 1-10V dimming system available on demand

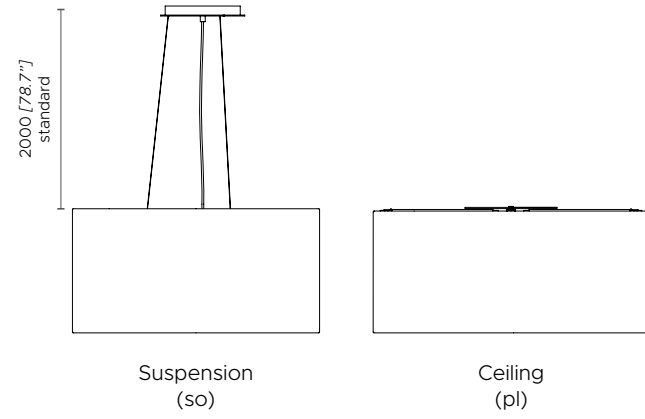

**Circus**

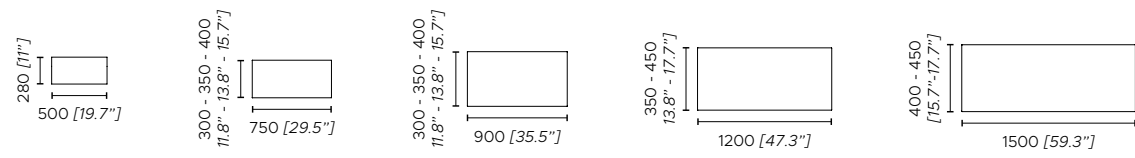

**Circus LED**

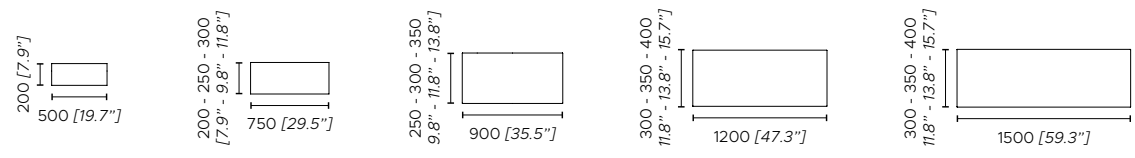

# Coco Mega & Deluxe

Coco Mega: Tristan Auer

Coco Deluxe: Tristan Auer & Frédéric Sicard



**Struttura / Frame**



1. Nickel lucido / Polished nickel

**Paralume / Shade**

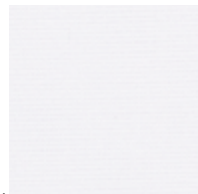

1. Cotone bianco / White cotton  
 2. Tessuto effetto marmo bianco Calacatta / White Calacatta marble printed fabric

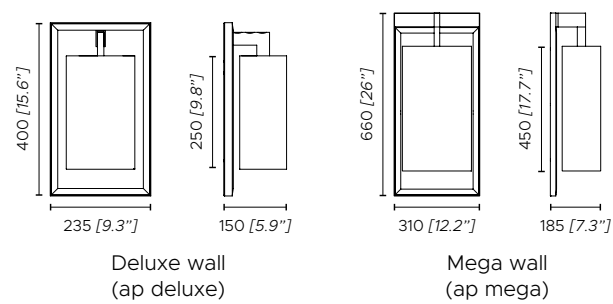
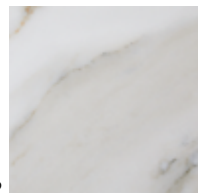

**Fonte luminosa - light source**

**220 - 240V:**

Mega ap - ta 1 x 14W E27 LED  
 Deluxe ap - ta 1 x 10W E27 LED

**110V:**

Mega ap - ta 1 x 14W E26 LED  
 Deluxe ap - ta 1 x 10W E26 LED

**Mega ap - Deluxe ap**

Compatibile con sistemi di controllo remoto in caso di utilizzo di lampadine LED dimmerabili  
 Compatible with remote control systems when dimmable LED bulbs are used

**Mega ta - Deluxe ta**

Disponibile su richiesta versione con dimmer su cavo, compatibile solo con lampadine LED dimmerabili  
 Dimmer switch on the cable available on demand, compatible with dimmable LED light bulbs only

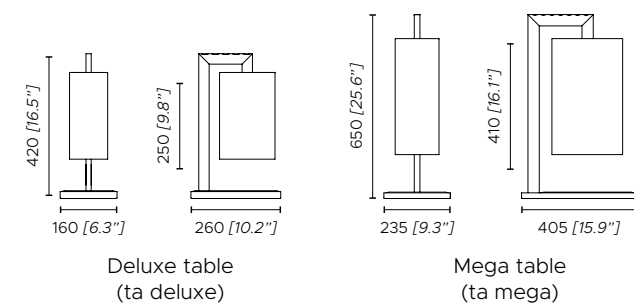



## Coco & Coconette

Tristan Auer & Frédéric Sicard

**Struttura / Frame**



**Coco - Coco mini IP44**

1. Nickel lucido / *Polished nickel*

**Coconette**

2. Bronzo spazzolato chiaro opaco / *Matt light satin bronze*

**Paralume / Shade**

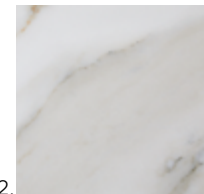

**Coco - Coconette**

1. Cotone bianco / *White cotton*  
 2. Tessuto effetto marmo bianco Calacatta / *White Calacatta marble printed fabric*

**Coco mini IP44**

3. Tessuto impermeabile bianco / *Waterproof white fabric*



Coconette



Coco

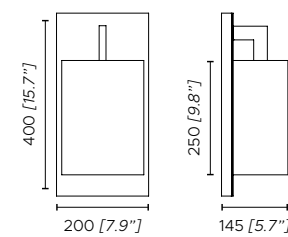

Coconette

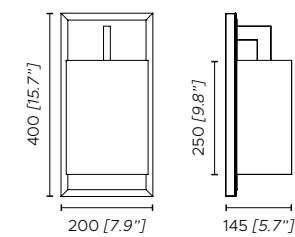

Coco

**Fonte luminosa - light source**

**220 - 240V:**

Coco - Coconette 1 x 10W E27 LED  
 Coco mini IP44 1 x 9W G9 LED

**110V:**

Coco - Coconette 1 x 10W E26 LED  
 Coco mini IP44 1 x 9W G9 LED

Compatibile con sistemi di controllo remoto in caso di utilizzo di lampadine LED dimmerabili  
*Compatible with remote control systems when dimmable LED bulbs are used*



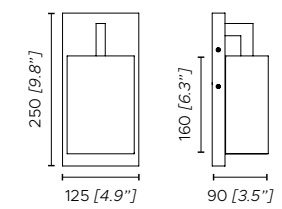

Coco mini IP44



# Ovale

Contardi Studio

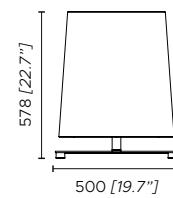
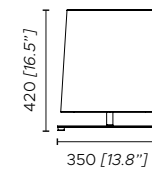

Table  
(ta)



Small table  
(ta small)



### Struttura / Frame



1.

2.

1. Bronzo spazzolato chiaro opaco / *Matt light satin bronze*  
 2. Laccato nero seta opaco / *Matt black silk lacquered*

### Paralume / Shade

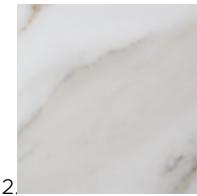

1.

2.

1. Cotone bianco / *White cotton*  
 2. Tessuto effetto marmo bianco Calacatta / *White Calacatta marble printed fabric*

① *Passamanerie disponibili su richiesta*  
*Trims available on demand*

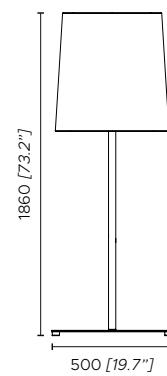

Floor  
(f)

### Fonte luminosa - Light source

**220 - 240V:**  
 Ta small 1 x 10W E27 LED  
 Ta 1 x 13W E27 LED  
 FI x 14W E27 LED

**110V:**  
 Ta small 1 x 10W E26 LED  
 Ta 1 x 13W E26 LED  
 FI x 14W E26 LED

### Ta - ta small

Disponibile su richiesta versione con dimmer su cavo, compatibile solo con lampadine LED dimmerabili  
*Dimmer switch on the cable available on demand, compatible with dimmable LED light bulbs only*

### FI

Disponibile su richiesta versione con dimmer a piede, compatibile solo con lampadine LED dimmerabili  
*Foot dimmer available on demand, compatible with dimmable LED light bulbs only*





Ap

Ap led

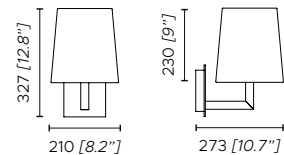

Wall  
(ap)

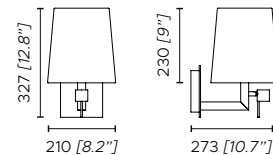

Wall led  
(ap led)

**Struttura / Frame**



1.



2.

- 1. Bronzo spazzolato chiaro opaco / *Matt light satin bronze*
- 2. Laccato nero seta opaco / *Matt black silk lacquered*

**Paralume / Shade**



1.

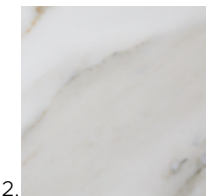

2.

- 1. Cotone bianco / *White cotton*
- 2. Tessuto effetto marmo bianco Calacatta / *White Calacatta marble printed fabric*

 *Passamanerie disponibili su richiesta*  
*Trims available on demand*

**Fonte luminosa - Light source**

**220 - 240V:**

- Ap - ta 1 x 10W E27 LED
- Ap LED 1 x 10W E27 LED +  
1 x 3W LED module; 2700 K; CRI: >90
- Ta desk 1 x 12W E27 LED
- FI - liseuse x 14W E27 LED

**110V:**

- Ap - ta 1 x 10W E26 LED
- Ap LED 1 x 10W E26 LED +  
1 x 3W LED module; 2700 K; CRI: >90
- Ta desk 1 x 12W E26 LED
- FI - liseuse x 14W E26 LED

**Ap**

Compatibile con sistemi di controllo remoto in caso di utilizzo di lampadine LED dimmerabili  
*Compatible with remote control systems when dimmable LED bulbs are used*

**Ta - ta desk**

Disponibile su richiesta versione con dimmer su cavo, compatibile solo con lampadine LED dimmerabili  
*Dimmer switch on the cable available on demand, compatible with dimmable LED light bulbs only*

**FI - liseuse**

Disponibile su richiesta versione con dimmer a piede, compatibile solo con lampadine LED dimmerabili  
*Foot dimmer available on demand, compatible with dimmable LED light bulbs only*

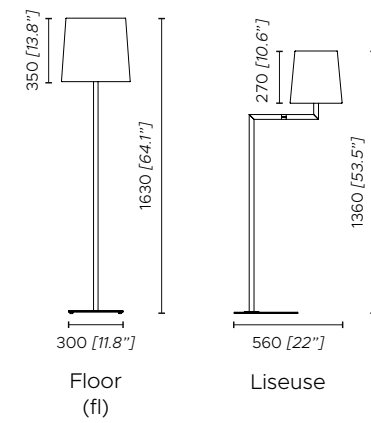
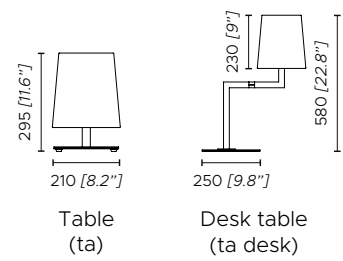
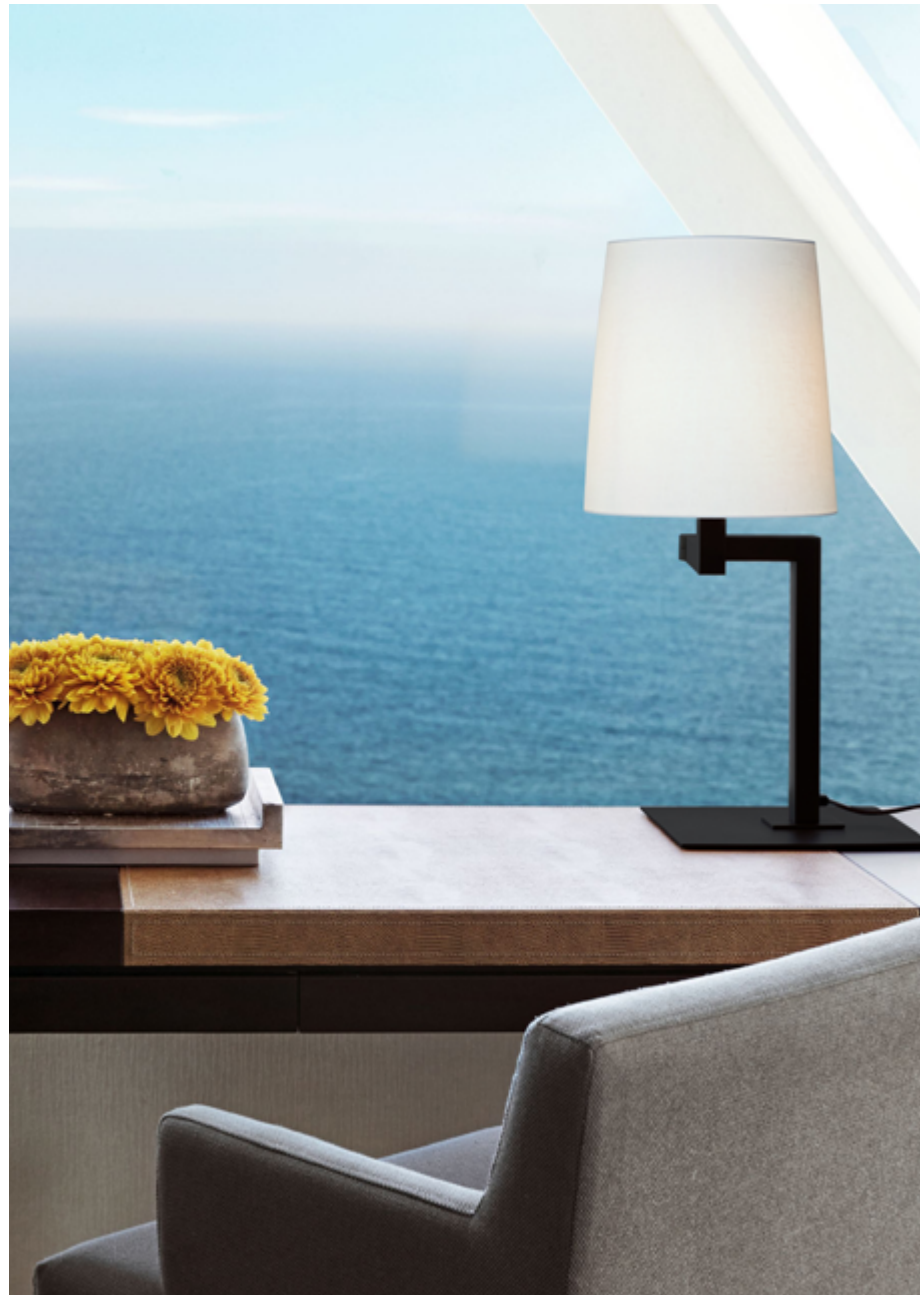



 contardi

outdoor





BLENDING  
TECHNOLOGY  
& CREATIVE  
DESIGN



### **1. Lo stile incontra la sostanza** *Timeless design created in Italy*

La nostra Collezione Outdoor è un chiaro esempio di questa combinazione ideale: un modo per portare all'esterno il mondo indoor, mantenendo le stesse caratteristiche decorative e di qualità del prodotto per interni, senza dimenticare l'aspetto pragmatico relativo alla destinazione d'uso. L'utilizzo di materiali e tessuti decorativi di alta qualità è combinato con finiture e caratteristiche richieste dai più alti standard, tra cui la certificazione IP65 e il trattamento di cataforesi "Marine Grade".

*We at Contardi interpret the outdoor collection as a way to bring the interior design to the open-air. The idea is to keep the same decorative and qualitative characteristics of the indoor products without forgetting the pragmatic aspect, specifically the intended use. The use of high-quality decorative materials and fabrics is successfully combined with finishes and regulations required for the highest standards, such as the IP65 and the "Marine Grade".*

B

6 **BABU**

C

14 **CALYBABU**  
18 **CALYPSO OUTDOOR** so, fl  
34 **COCO OUTDOOR**  
38 **CUBE OUTDOOR** wired, battery

F

44 **FREEDOM** wired, battery

L

50 **LAGOON**

M

56 **MUSE LANTERN OUTDOOR** so, wired, battery  
64 **MUSE OUTDOOR** so, wired, battery

T

72 **TENEBRA** wired, battery

**Lampada a parete**  
Wall lamp

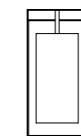

Coco Outdoor  
34



Freedom  
44

**Lampada a sospensione**  
Suspension lamp



Calypso Outdoor  
18



Muse Lantern Outdoor  
56



Muse Outdoor  
64



Tenebra  
72

**Lampada da terra & pouf**  
Floor lamp & pouf



Babu  
6



Calypso Outdoor  
18



Cube Outdoor  
38



Freedom  
44

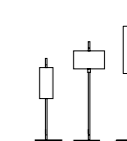

Lagoon  
50



Muse Lantern Outdoor  
56



Muse Outdoor  
64



Calybabu  
14

**Lampada da tavolo**  
Table lamp



Freedom  
44



Muse Lantern Outdoor  
56



Muse Outdoor  
64

**Lampada a batteria**  
Battery lamp



Cube Outdoor  
38



Freedom  
44



Muse Lantern Outdoor  
56



Muse Outdoor  
64



Tenebra  
72

# Babu

Massimiliano Raggi



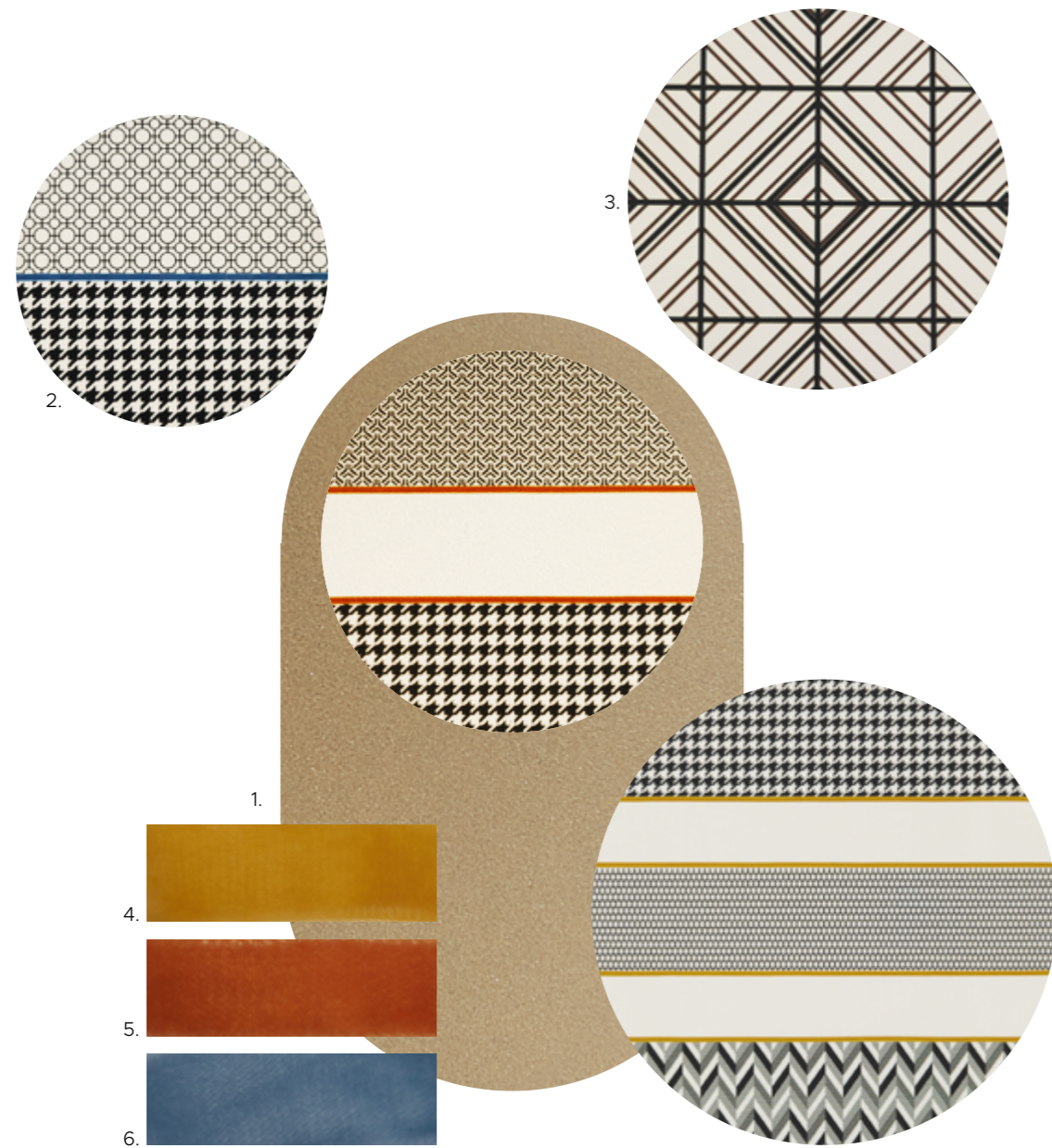

1. Acciaio laccato effetto champagne, trattamento cataforesi Marine Grade

2. Stampa Textile digitale 3D su tessuto  
3. Stampa Tribal digitale 3D su tessuto

4. Passamaneria in velluto outdoor senape  
5. Passamaneria in velluto outdoor arancio  
6. Passamaneria in velluto outdoor blu avio

*Stampa digitale 3D su tessuto personalizzabile su richiesta*

**Fonte luminosa - Light source**

**220 - 240V:**  
Small 1 x 17W Strip LED; 3000 K; CRI: >90  
Medium 1 x 24W Strip LED; 3000 K; CRI: >90  
Large 1 x 34W Strip LED; 3000 K; CRI: >90

IP65

1. Champagne lacquered steel, Marine Grade with cataphoresis treatment

2. 3D digital Textile printing on fabric  
3. 3D digital Tribal printing on fabric

4. Mustard colour velvet trim for outdoor use  
5. Orange colour velvet trim for outdoor use  
6. Aviation blue colour velvet trim for outdoor use

*3D digital printing fabric customizable fabric on demand*

**110V:**  
Small 1 x 17W Strip LED; 3000 K; CRI: >90  
Medium 1 x 24W Strip LED; 3000 K; CRI: >90  
Large 1 x 34W Strip LED; 3000 K; CRI: >90

IP65

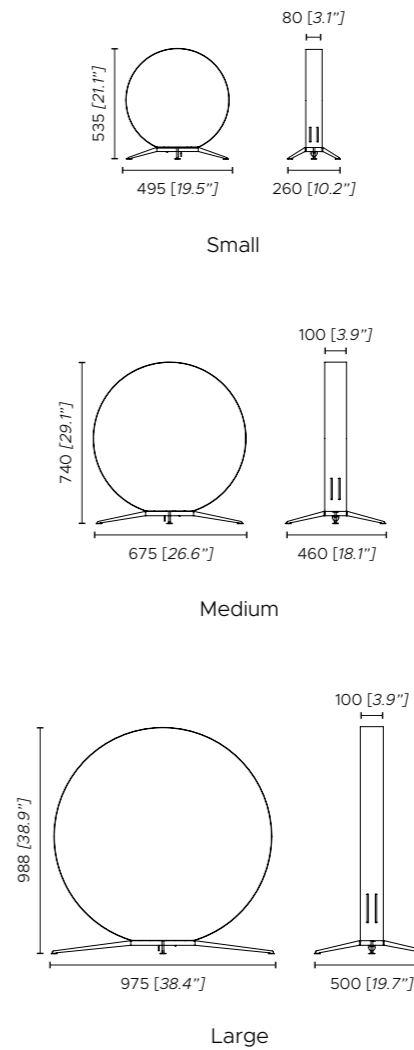



STAMPA 3D **TEXTILE & TRIBAL**  
3D PRINT **TEXTILE & TRIBAL**



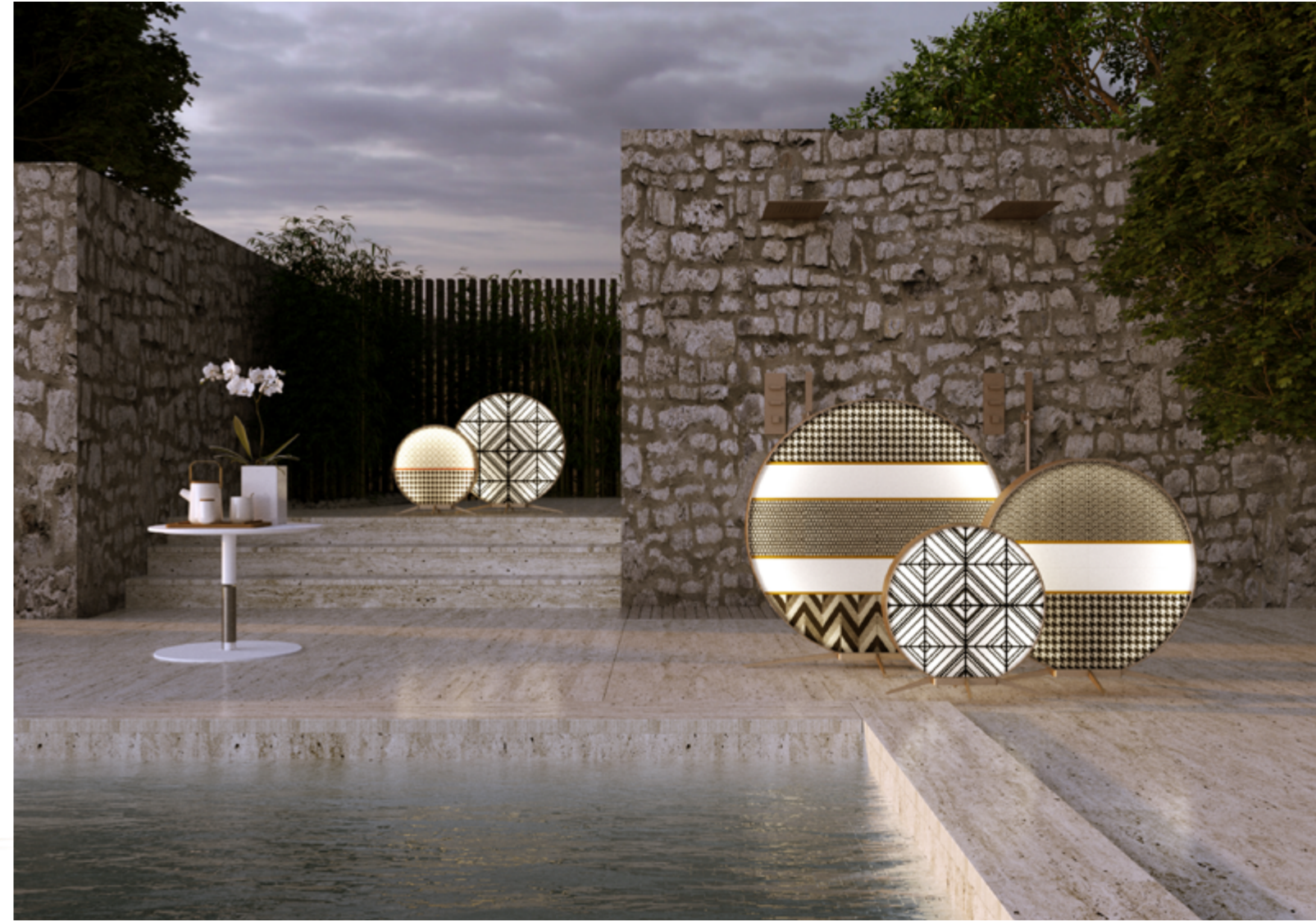

# Calybabu

Massimiliano Raggi





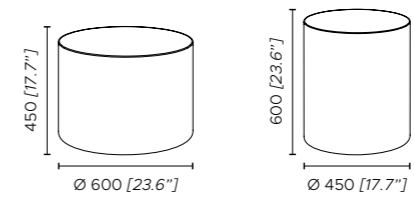
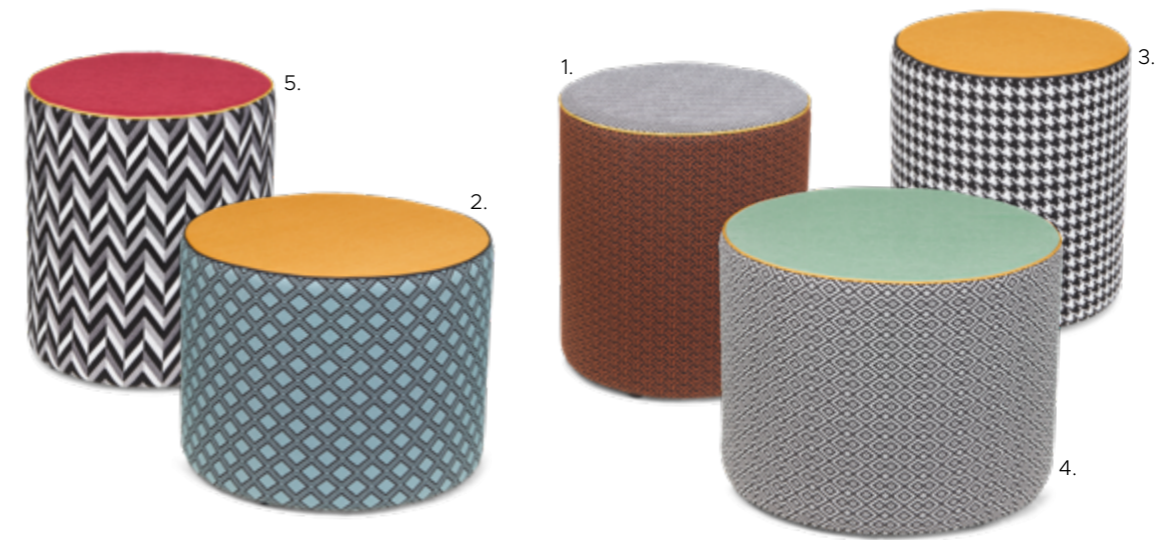

1. Pattern H  
2. Pattern I  
3. Pattern L

4. Pattern M  
5. Pattern N

# Calypso outdoor

Servomuto





- 1. Struttura ottone satinato
- 2. Corda da marina impermeabile intrecciata in tinta verde
- 3. **Paralume so:** Antigua, Guadaloupe, Martinique
- 4. Diffusore vetro trasparente

**Fonte luminosa - Light source**

**220 - 240V:**  
1 x 9W E27 T8 Tubular LED

IP65

- 1. Satin brass frame
- 2. Green waterproof braided rope
- 3. **So shade:** Antigua, Guadaloupe, Martinique
- 4. Transparent glass diffuser

**110V:**  
1 x 9W E26 T8 Tubular LED

IP65

Compatibile con sistemi di controllo remoto in caso di utilizzo di lampadine LED dimmerabili  
*Compatible with remote control systems when dimmable LED bulbs are used*



# CALYPSO SO



Antigua  
Mint



Guadeloupe  
Mint



Martinique  
Yellow



Antigua  
Black



Guadeloupe  
Black



Martinique  
Black



Antigua  
Sale & Pepe



Guadeloupe  
Sale & Pepe



Martinique  
Building

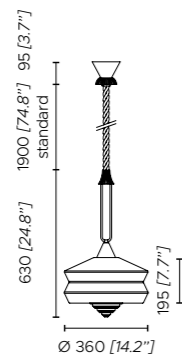

Antigua

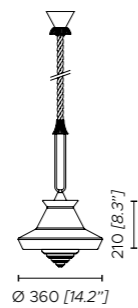

Guadeloupe

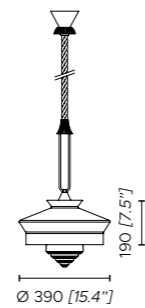

Martinique





## CALYPSO SO XL



**Antigua**  
Mint



**Guadaloupe**  
Sale & Pepe



**Martinique**  
Yellow

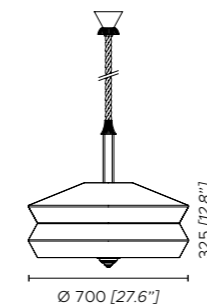

Antigua

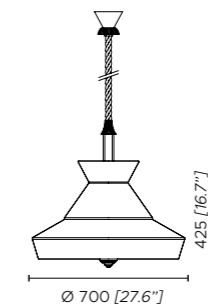

Guadaloupe

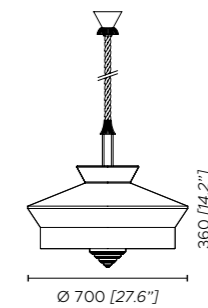

Martinique

**Fonte luminosa - Light source**

**220 - 240V:**  
1 x 9W E27 T8 Tubular LED

IP65

**110V:**  
1 x 9W E26 T8 Tubular LED

IP65

Compatibile con sistemi di controllo remoto in caso di utilizzo di lampadine LED dimmerabili  
Compatible with remote control systems when dimmable LED bulbs are used



CALYPSO  
**FLOOR  
OUTDOOR**  
Servomuto



GEOMETRIC  
**PATTERNS**  
& BRIGHT  
**COLOURS**

---

TRAME GEOMETRICHE & COLORI BRILLANTI

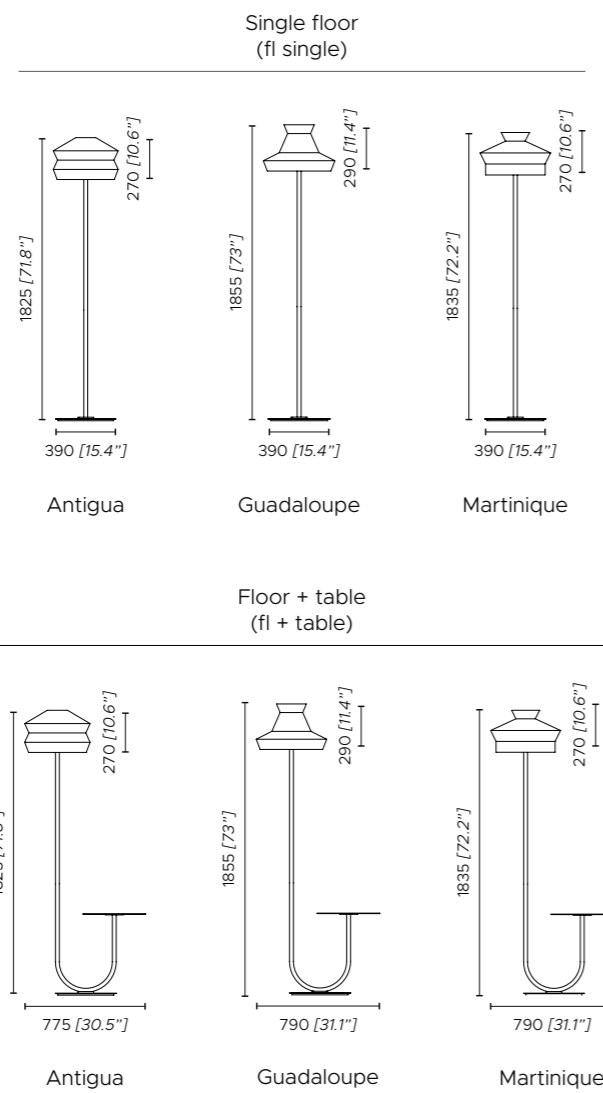

- 1. Laccato nero opaco
- 2. Laccato verde reseda

3. **Paralume fl:** Antigua, Guadaloupe, Martinique

**Fonte luminosa - Light source**

**220 - 240V:**  
1 x 9W E27 T8 Tubular LED

IP65

- 1. Matt black lacquered
- 2. Reseda green lacquered

3. **Fl shade:** Antigua, Guadaloupe, Martinique

**110V:**  
1 x 9W E26 T8 Tubular LED

IP65

Compatibile con sistemi di controllo remoto in caso di utilizzo di lampadine LED dimmerabili  
Compatible with remote control systems when dimmable LED bulbs are used





# Coco outdoor

Tristan Auer



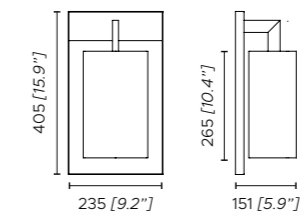

Small

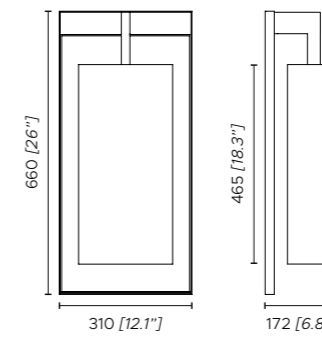

Mega

- 1. Acciaio spazzolato
- 2. Resina effetto legno marino moca scuro con trattamento impermeabilizzante
- 3. Tessuto impermeabile Sale & Pepe

**Fonte luminosa - Light source**

**220 - 240V:**  
 Small 1 x 10W E27 LED  
 Mega 1 x 14W E27 LED

IP65

- 1. Satin steel
- 2. Dark mocha marine wood effect resin with waterproof treatment
- 3. Sale & Pepe waterproof fabric

**110V:**  
 Small 1 x 10W E26 LED  
 Mega 1 x 14W E26 LED

IP65

Compatibile con sistemi di controllo remoto in caso di utilizzo di lampadine LED dimmerabili  
 Compatible with remote control systems when dimmable LED bulbs are used



## Cube outdoor

Massimiliano Raggi

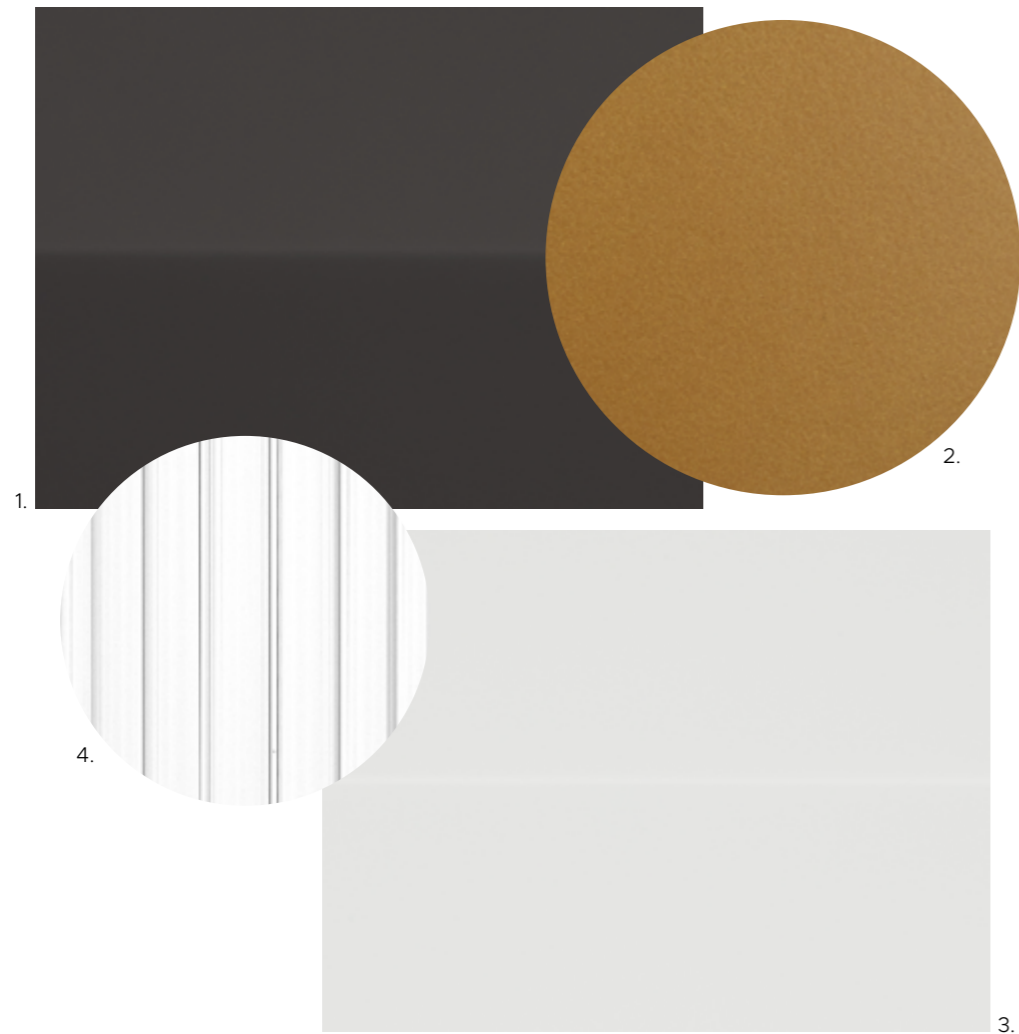

- 1. Esterno: bronzo scuro
- 2. Interno: laccato oro, trattamento cataforesi Marine Grade
- 3. Laccato bianco opaco, trattamento cataforesi Marine Grade
- 4. Diffusore plexiglass rigato

- 1. Outside: dark bronze
- 2. Inside: gold lacquered, Marine Grade with cataphoresis treatment
- 3. Matt white lacquered, Marine Grade with cataphoresis treatment
- 4. Striped plexiglass diffuser

**Fonte luminosa - Light source**

**220 - 240V:**  
**Cablata/wired** 1 x 10W E27 LED  
**Batteria/battery** 1 x 4W LED module; 2700 K; CRI: >90

IP65

**110V:**  
**Cablata/wired** 1 x 10W E26 LED  
**Batteria/battery** 1 x 4W LED module; 2700 K; CRI: >90

IP65

**Cablata/wired**

Compatible con sistemi di controllo remoto in caso di utilizzo di lampadine LED dimmerabili  
 Compatible with remote control systems when dimmable LED bulbs are used



Cablata / Wired

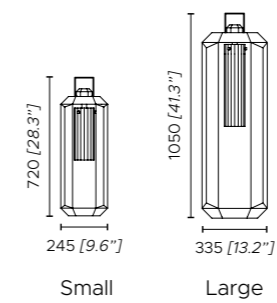

Batteria / Battery

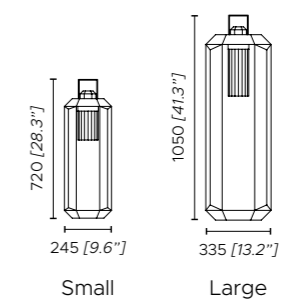



VERSIONE A **BATTERIA**  
**BATTERY OPERATED VERSION**



ACCENSIONE / SPEGNIMENTO  
ON / OFF SWITCHING

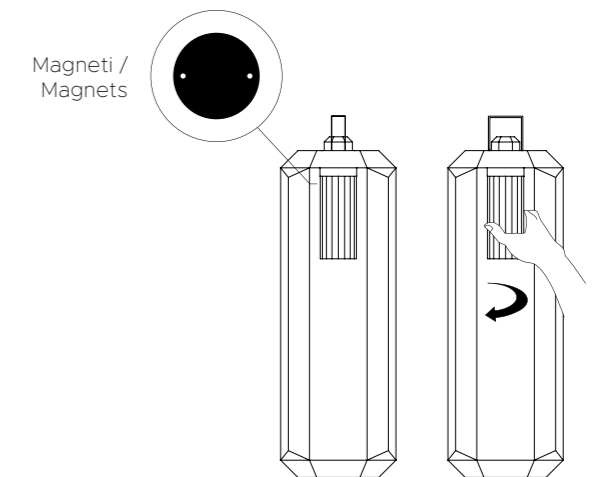

# Freedom

Massimiliano Raggi



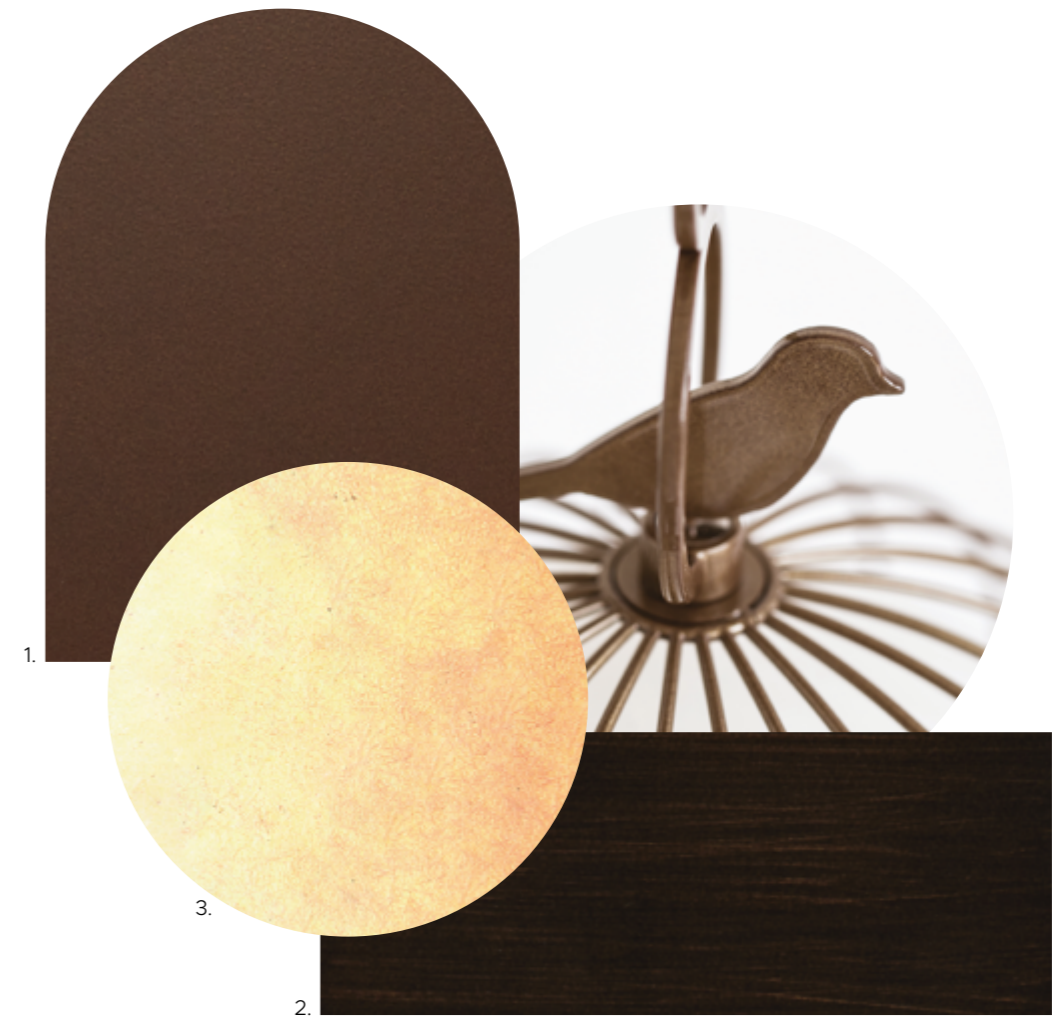

1. Gabbia in metallo verniciato bronzo
2. Base in legno marino marrone scuro con trattamento cataforesi
3. Diffusore vetroresina crema

**Fonte luminosa - Light source**

**220 - 240V:**  
**Cablata/wired** 1 x 10W E27 LED  
**Batteria/battery** 1 x 3W LED module; 2700 K; CRI: >90

IP65

**Cablata/wired**

Compatibile con sistemi di controllo remoto in caso di utilizzo di lampadine LED dimmerabili  
 Compatible with remote control systems when dimmable LED bulbs are used

1. Cage in bronze lacquered metal
2. Dark brown marine wood with waterproof treatment for the base
3. Cream-coloured fiberglass diffuser

**110V:**  
**Cablata/wired** 1 x 10W E26 LED  
**Batteria/battery** 1 x 3W LED module; 2700 K; CRI: >90

IP65





**ACCESSORI** FREEDOM BATTERY  
*FREEDOM BATTERY ACCESSORIES*



Gancio da parete  
Hook for wall

Gancio per piantana  
Hook for floor

Piastra da terra  
Ground plate

# Lagoon

Servomuto



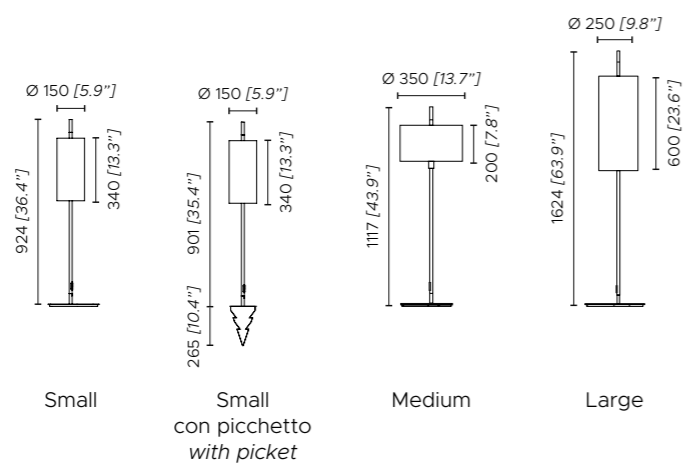

- 1. Laccato nero opaco
- 2. Laccato rame

- 3. Paralume Noimea Goyave (Pierre Frey)
- 4. Paralume Dominica Caraibes (Pierre Frey)
- 5. Paralume Bayamo Mimosa (Pierre Frey)

**Fonte luminosa - Light source**

**220 - 240V:**  
1 x 9W E27 T8 Tubular LED

IP65

- 1. Matt black lacquered
- 2. Copper lacquered

- 3. Noimea Goyave shade (Pierre Frey)
- 4. Dominica Caraibes shade (Pierre Frey)
- 5. Bayamo Mimosa shade (Pierre Frey)

**110V:**  
1 x 9W E26 T8 Tubular LED

IP65

Compatibile con sistemi di controllo remoto in caso di utilizzo di lampadine LED dimmerabili  
Compatible with remote control systems when dimmable LED bulbs are used



# Muse lantern outdoor

Tristan Auer



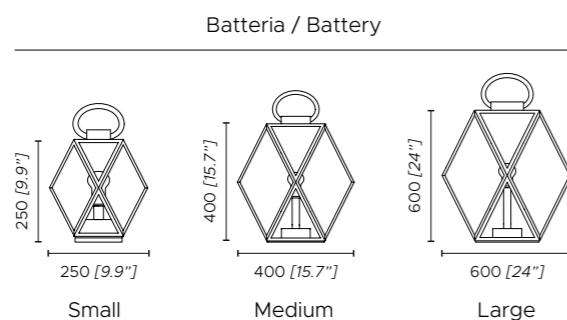

1. Laccato bronzo, trattamento cataforesi Marine Grade

2. Maniglia in cuoio intrecciata marrone

3. Diffusore acrilico color ambra

1. Bronze lacquered, Marine Grade with cataphoresis treatment

2. Brown braided leather handle

3. Amber acrylic diffuser

**Fonte luminosa - Light source**

**220 - 240V:**  
**Cablata/wired** - so 1 x 10W E27 LED  
**Batteria/battery** 1 x 3W LED module; 3000 K; CRI: >90

**110V:**  
**Cablata/wired** - so 1 x 10W E26 LED  
**Batteria/battery** 1 x 3W LED module; 3000 K; CRI: >90

IP65

IP65

**Cablata/wired**  
 Compatible con sistemi di controllo remoto in caso di utilizzo di lampadine LED dimmerabili  
 Compatible with remote control systems when dimmable LED bulbs are used



Cablata / Wired

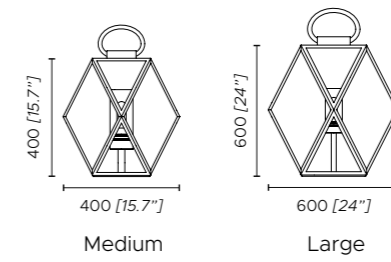

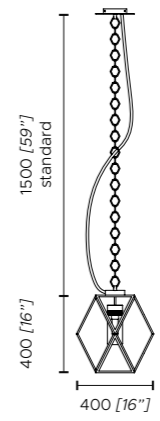

Medium suspension  
(so medium)

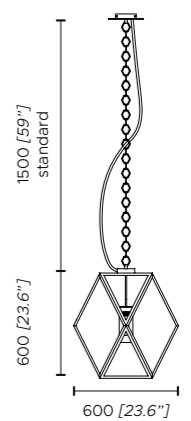

Large suspension  
(so large)



# Muse outdoor

Tristan Auer



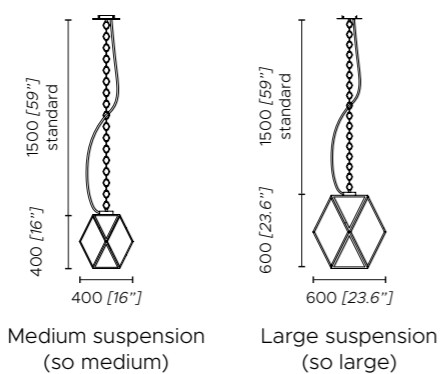

- 1. Laccato bianco opaco, trattamento cataforesi Marine Grade
- 2. Laccato nero opaco, trattamento cataforesi Marine Grade

- 3. Maniglia in cuoio intrecciato bianco/nero

- 4. Diffusore acrilico satinato

**Fonte luminosa - Light source**

**220 - 240V:**  
**Cablata/wired** - so 1 x 10W E27 LED  
**Batteria/battery** 1 x 3W LED module; 3000 K; CRI: >90

IP65

**Cablata/wired**

Compatibile con sistemi di controllo remoto in caso di utilizzo di lampadine LED dimmerabili  
 Compatible with remote control systems when dimmable LED bulbs are used

- 1. Matt white lacquered, Marine Grade with cataphoresis treatment
- 2. Matt black lacquered, Marine Grade with cataphoresis treatment

- 3. White/black braided leather handle

- 4. Satin acrylic diffuser

**110V:**  
**Cablata/wired** - so 1 x 10W E26 LED  
**Batteria/battery** 1 x 3W LED module; 3000 K; CRI: >90

IP65



Cablata / Wired

Batteria / Battery

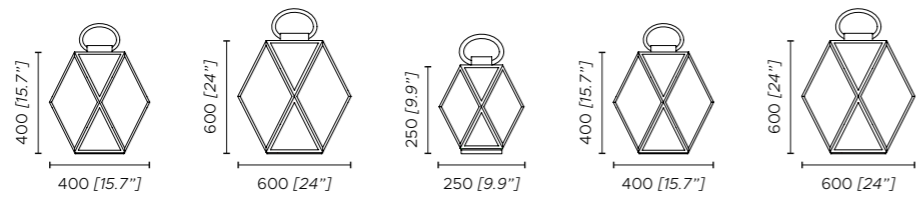



# Tenebra

Jan Van Lierde



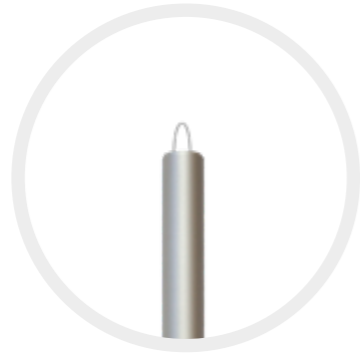

VERSIONE **A BATTERIA,**  
**SENZA ROSONE**  
**BATTERY OPERATED**  
**VERSION, WITHOUT CANOPY**

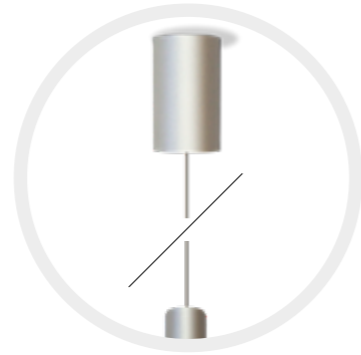

VERSIONE **CABLATA,**  
**CON ROSONE**  
**WIRED VERSION,**  
**WITH CANOPY**

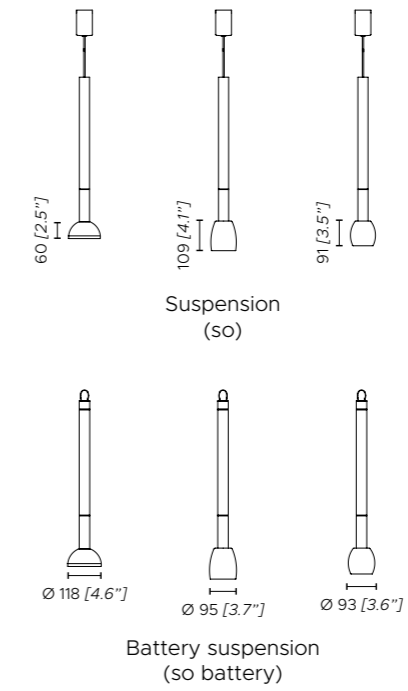

- 1. Laccato argento
- 2. Laccato oro rosa
- 3. Laccato nero opaco

**Fonte luminosa - Light source**

**220 - 240V:**  
1 x 3W LED module; 2700 K; CRI: >90

IP65

**Batteria/battery**  
Dimmerabile  
*Dimmable*

- 1. Silver lacquered
- 2. Rose gold lacquered
- 3. Matt black lacquered

**110V:**  
1 x 3W LED module; 2700 K; CRI: >90

IP65

## ACCESSORI TENEBRA / TENEBRA ACCESSORIES

DIFFUSORI PER VERSIONE  
CABLATA E A BATTERIAWIRED & BATTERY OPERATED  
DIFFUSERS

1.



2.



3.

1. Diffusore cristallo sintetico, Venezia ambra
2. Diffusore cristallo sintetico, Lente grigio
3. Diffusore cristallo sintetico, Crystal Macedonia

1. Diffuser synthetic crystal, Venezia Amber
2. Diffuser synthetic crystal, Grey lens
3. Diffuser synthetic crystal, Crystal Macedonia

ACCESSORI DI FISSAGGIO  
PER VERSIONE A BATTERIA (inclusi)BATTERY OPERATED  
HANGING ACCESSORIES (included)

## Accessori di fissaggio (inclusi)

1 x staffa per attacco a soffitti + 1 x griplock +  
1 x bloccacavo + 1 x cavo in acciaio l. 2m +  
1 x gancio standard

## Hanging accessories (included)

1 x ceiling attachment + 1 x griplock + 1 x screw lock +  
1 x steel cable l. 2m + 1 x standard hook

## Accessori versione a batteria (non inclusi) / Battery operated version accessories (not included)



ACCESSORI "A" (non inclusi)  
1 x cavo in acciaio l. 2m + 1 x gancio design

"A" ACCESSORIES (not included)  
1 x steel cable l. 2m + 1 x design hook



ACCESSORI "B" (non inclusi)  
1 x tirante + 2 x bloccacavo + 1 x cavo in acciaio l.10m +  
6 x griplock

"B" ACCESSORIES (not included)  
1 x tie rod + 2 x screw lock + 1 x steel cable l. 10m +  
6 x griplock



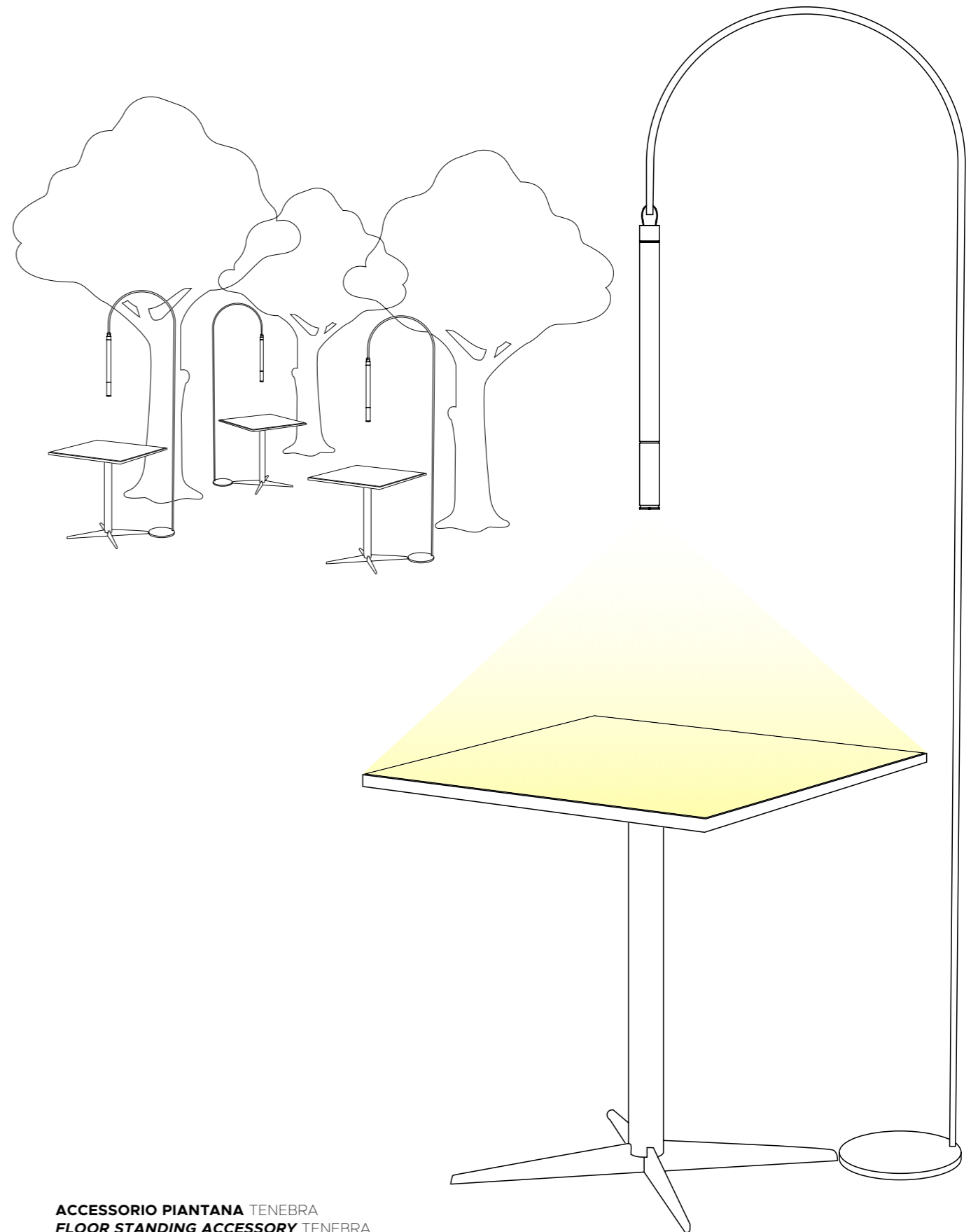

**ACCESSORIO PIANTANA TENEBRA**  
**FLOOR STANDING ACCESSORY TENEBRA**





## THANKS TO

**Graphic Project:**

Claudia Parisi

**Photo Creative Direction:**

STUDIOBLUM

**Styling:**

Martina Caiazzo

**Mise en page:**

Martina Castiglieri

**Photos:**

Francesco Romeo

Lakeroom

Marco Reggi

**Render:**

Operavisual

Studio Massimiliano Raggi

MKV Design

Arché Agency

**Photos of page:**

Casablanca Fotografia (p. 63)

Fabio Grande (p. 67)

Milène Servelle Photographe (p. 159)

Yvan Grubski Phothographer (p.7\_i)

Francis Amiand Photographe (p. 62\_out)

Stuart Pearce (p. 71\_out)

**Styling of page:**

John Mac Donald, Tilburg (p. 42, 184)

BenchMark Design, Tilburg (p. 45)

NB-Studio, Moscow (p. 61)

Joaquim Homs (p. 63)

Alessandra Notarangelo Architetto, Italy (p. 67)

Grani Studio, Sochi (p. 98)

Tamma Architecture, Monaco (FR) (p. 147)

Goddard Little Fair, London (p. 178)

Maurizio Di Mauro Architetto, Italy (p. 181)

Maison Numéro 20 / Oscar Lucien Ono, Paris (p. 62\_out)

Gunter & Co Interiors, London (p. 69\_out)

FM Architettura d'interni, Italy (p. 71\_out)

**Thanks to:**

MONOMIO

Ilya Barton

Jole Lombardini

Marco Billotti

Stefano Mandelli

Pietro Di Pace

Meroni e Colzani

CTS Salotti

Casa Casati

On House Milano

Thesign srl

Buro Tsum Restaurant, Moscow

Cavo Tagoo, Mykonos

Motel One Frankfurt Römer, Frankfurt

Fonteverde Hotel, San Casciano dei Bagni

Bartolo & Sons, Palermo

Egetemeier Wohnkultur, Germany

Sabrina Montecarlo, Monaco (FR)

Four Season Hotel Megeve, France

**Print:**

Grafiche Antiga, Crocetta del Montello (TV)

©Contardi Lighting srl

02.2023



**CONTARDI LIGHTING Srl**

Via A. Manzoni, 134/140 - 20811 Cesano Maderno (MB) - Italia  
Tel. +39 0362 301381 - Fax +39 0362 307473

[sales@contardi-italia.it](mailto:sales@contardi-italia.it) - [contardi-italia.com](http://contardi-italia.com)