

contardi

Collections

 **contardi**

COUTURIER OF LIGHT



Design and production Made in Italy

Contardi Lighting is based in Brianza, a region internationally recognized as the ultimate furniture district and the cradle of Italian design. This is where Contardi products come to life, sometimes conceived and developed in-house, and sometimes the result of coordination with the creative flair of international designers. These designers work closely with the company's technical office, which, thanks to its vast experience, creates products of extraordinary quality and attention to detail. Local, "zero-mile" production, entrusted to carefully selected suppliers within the Brianza district, ensures the renowned quality of "Made in Italy," appreciated and recognized worldwide through decades of industry experience.

The archi-decorative style

Contardi Lighting's style is defined as 'archi-decorative', a style in which a harmonious balance between aesthetics and functionality is achieved through the convergence of several elements: the variety of materials used, the elegance of the finishes, and the bespoke approach, on one hand, which define the unmistakable character of each design, and on the other, technological innovation, adherence to the highest safety standards, and compliance with all the required certifications for various markets. For Contardi Lighting, a decorative lighting object is an ambitious and sophisticated product: it must be able to illuminate and do so masterfully.

Il design e la produzione Made in Italy

Contardi Lighting ha sede in Brianza, territorio riconosciuto a livello internazionale come il distretto per eccellenza dell'arredo e culla del design italiano. È qui che prende vita il design dei prodotti Contardi, talvolta concepiti e sviluppati internamente, talvolta frutto del coordinamento con l'estro creativo di designer internazionali. Questi ultimi collaborano strettamente con l'ufficio tecnico dell'azienda, che grazie alla sua vasta esperienza, dà origine a prodotti di straordinaria qualità e cura dei dettagli. La produzione locale, a "chilometro zero", affidata a fornitori accuratamente selezionati nel distretto brianzolo, attraverso decenni di esperienza nel settore, assicura la rinomata qualità del Made in Italy, apprezzata e riconosciuta in tutto il mondo.

Lo stile archi-decorativo

Lo stile di Contardi Lighting si definisce archi-decorativo ovvero uno stile in cui l'armonioso equilibrio tra estetica e funzionalità è ottenuto dal confluire di diversi elementi: la varietà dei materiali impiegati, l'eleganza delle finiture e l'approccio sartoriale, che definiscono il carattere inconfondibile di ogni proposta da un lato, e la tecnologia avanzata, il rispetto dei più elevati standard in termini di sicurezza e il possesso di tutte le certificazioni richieste dai vari mercati dall'altro. Per Contardi Lighting l'oggetto luminoso decorativo è un prodotto ambizioso e sofisticato: deve saper illuminare e farlo magistralmente.



Contardi USA

Contardi Lighting's international growth was solidified in 2015 with the opening of its American subsidiary, Contardi USA, in New York.

This was a crucial step in a market that has always played a key role for the brand and has seen the completion of important projects in the hospitality sector over the years, thanks to Contardi Lighting's ability to develop cutting-edge lighting solutions that fully comply with the highest standards and specific required certifications.

With the opening and presence of the American subsidiary, Contardi ensures a direct presence in one of the world's key locations, responding in real-time to the needs arising from this market.

La crescita internazionale di Contardi Lighting è stata consacrata nel 2015 dall'apertura a New York della filiale americana, la Contardi USA.

Una tappa fondamentale in un mercato che da sempre riveste un ruolo chiave per il brand e che ha visto, nel corso degli anni, la realizzazione di importanti progetti legati al mondo dell'hospitality, grazie alla capacità di Contardi Lighting di sviluppare soluzioni illuminotecniche d'avanguardia, nel pieno rispetto dei più elevati standard e delle certificazioni specifiche richieste.

Con l'apertura e presenza della filiale americana, Contardi garantisce un presidio diretto in uno dei punti nevralgici del mondo rispondendo in tempo reale alle esigenze provenienti da questo mercato.



Designers

CHIARA CABERLON



Chiara Caberlon is an architect and interior designer who has turned the art of creativity into a profession. For her, beauty is a way of life, reflected in attention to detail, harmony, and balance. Her studio, founded in 2004, stands out for its innovation in tailor-made hospitality concepts, combining flexibility and bespoke design.

Chiara Caberlon è un architetto e interior designer che ha trasformato il gioco della creatività in professione. Per lei, il bello è un modo di vivere, riflesso nell'attenzione ai dettagli, nell'armonia e nell'equilibrio. Il suo studio fondato nel 2004 si distingue per l'innovazione nei concept di ospitalità tailor-made unendo flessibilità e sartorialità.

CONTROVENTO

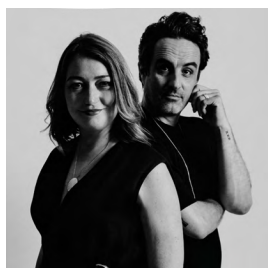

Controvento is a creative collective that combines design, strategy, and cultural vision. With a multidisciplinary approach and an international team, it designs objects, spaces, and experiences that connect people and brands, blending storytelling, craftsmanship, and innovation to create designs that leave a lasting impact, today and tomorrow.

Controvento è un collettivo creativo che unisce design, strategia e visione culturale. Con un approccio multidisciplinare e un team internazionale, progetta oggetti, spazi ed esperienze che connettono persone e brand, fondendo storytelling, artigianato e innovazione per creare design capaci di lasciare un segno, oggi e domani.

DAAA HAUS



DAAA Haus is a multidisciplinary architecture and design studio that sees design as a language to improve the world. Inspired by creativity, fun, and a sense of responsibility, they create projects that anticipate change, meet needs, and leave a lasting mark on the contemporary landscape.

DAAA Haus è uno studio multidisciplinare di architettura e design che vede nel design un linguaggio per migliorare il mondo. Ispirati da creatività, divertimento e senso di responsabilità, creano progetti che anticipano i cambiamenti, rispondono ai bisogni e lasciano un'impronta duratura nel paesaggio contemporaneo.

DAINELLI STUDIO



Founded in 2007 by Leonardo and Marzia Dainelli, Dainelli Studio stands out for its continuous aesthetic and formal research, which is embodied in a refined design that pays close attention to the harmony between shapes, colors, and materials. Each of their projects carries with it a deep design culture combined with knowledge of both industrial and artisanal production techniques and processes.

Fondato nel 2007 da Leonardo e Marzia Dainelli, Dainelli Studio si distingue per la continua ricerca estetica e formale che si concretizza in un design ricercato, attento all'armonia tra forme, colori e materiali. Ogni loro progetto, porta con sé una profonda cultura progettuale unita alla conoscenza delle tecniche e dei processi produttivi industriali ed artigianali.

ALESSANDRO MUNGE

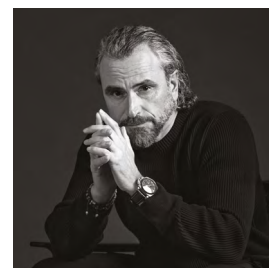

Founder and creative director of Studio Munge, Alessandro Munge designs iconic projects worldwide, combining architecture, interior, and product design. With a narrative and visionary style, he creates engaging experiences and spaces that blend luxury, innovation, and timeless identity, connecting people and enhancing brands.

Fondatore e direttore creativo di Studio Munge, Alessandro Munge firma progetti iconici in tutto il mondo, unendo architettura, interior e product design. Con uno stile narrativo e visionario, crea esperienze coinvolgenti e spazi che coniugano lusso, innovazione e identità senza tempo, che connettono le persone e valorizzano i brand.

PAOLA NAVONE / OTTO STUDIO



Architect, interior designer, art director, Paola Navone is a designer with an eclectic, candid, and dreamlike soul. Her spirit blends the flavors and colors of the southern world with the tastes and forms of the tradition-rich West. From this stems her inexhaustible curiosity for exploring materials, forms, and structures, which today is a defining element of Otto Studio.

Architetto, interior designer, art director, Paola Navone è una progettista dall'anima eclettica, schietta e sognatrice. Nella sua visione convivono sapori e colori del sud del mondo, uniti al gusto e alle forme dell'Occidente ricco di tradizioni. Da tutto ciò deriva l'inesauribile curiosità verso la ricerca di materie, forme e strutture, oggi elemento distintivo di Otto Studio.

MASSIMILIANO RAGGI



Interior and product designer, Massimiliano Raggi creates refined and timeless projects through a creative process aimed at achieving a synergy between function, formal research, and stylistic harmony. The clean lines and delicate details of his products are enhanced by the use of high-quality materials, evoking a sense of sophisticated essentiality.

Interior e product designer, Massimiliano Raggi crea progetti raffinati e senza tempo attraverso un processo creativo teso a raggiungere una sinergia tra funzione, ricerca formale e armonia stilistica. Le linee pulite e i dettagli delicati dei suoi prodotti sono valorizzati dall'uso di materiali pregiati, evocando un senso di sofisticata essenzialità.

CONTARDI STUDIO







Contardi Studio is Contardi's in-house Research & Development team, where engineers and designers work synergistically to create decorative and functional lighting solutions. Driven by a careful analysis of trends, materials, technologies, and project requirements, it develops innovative products ideal for both residential and commercial spaces.

Contardi Studio è il team interno di Ricerca e Sviluppo di Contardi, dove tecnici e designer collaborano sinergicamente per creare soluzioni di illuminazione decorativa e funzionale. Guidato da un'attenta analisi di trend, materiali, tecnologie e requisiti progettuali, sviluppa prodotti innovativi ideali per spazi residenziali e commerciali.







Indoor index

| | | | | |
|-----|----------------|---------------------------------------------------------------------------------------|---------------------------------------------------------------------------------------|---------------------------------------------------------------------------------------|
| P16 | Alma |  |  |  |
| P34 | Bianca |  | | |
| P44 | Fly XL |  |  |  |
| P56 | Hat |  |  |  |
| P70 | Picchio |  |  |  |

INDOOR ICONS / ICONE INDOOR

| | | | | |
|---------------------------------------------------------------------------------------|---------------------------------------------------------------------------------------|---------------------------------------------------------------------------------------|---------------------------------------------------------------------------------------|---------------------------------------------------------------------------------------|
|  |  |  |  |  |
| Suspension Sospensione | Wall Parete | Table Tavolo | Floor Terra | Reading Lettura |

Outdoor index

| | | |
|------|--------------|-------------------------------------------------------------------------------------------------------------------------------------------------------------------------------------------------------------------------------------------------------------|
| P82 | Bloom |  |
| P90 | Clara |    |
| P100 | Kiki |   |

OUTDOOR ICONS / ICONE OUTDOOR

| | | | | |
|---------------------------------------------------------------------------------------|---------------------------------------------------------------------------------------|---------------------------------------------------------------------------------------|---------------------------------------------------------------------------------------|---------------------------------------------------------------------------------------|
|  |  |  |  |  |
| Ceiling Plafone | Wall Parete | Table Tavolo | Floor Terra | Battery Batteria |

Indoor



Alma

CONTROVENTO

Alma transforms light into a poetic presence. Blown glass and pleated fabric diffusers blend together in pendant, table and floor lamps. Sculptural shapes and delicate colors create light, contemporary compositions that redefine space with elegance and a touch of surprise, creating welcoming, refined environments with a distinctive character.

Alma trasforma la luce in una presenza poetica. Vetro soffiato e diffusore in tessuto plissé si fondono in sospensioni, lampade da tavolo e da terra. Forme scultoree e colori delicati danno vita a composizioni leggere e contemporanee, capaci di ridefinire lo spazio con eleganza e sorpresa, creando ambienti accoglienti, raffinati e dal carattere distintivo.

PH
P
P





Detail of Alma's pleated fabric
with integrated light source.
Dettaglio del tessuto plissettato di Alma
con fonte luminosa integrata.



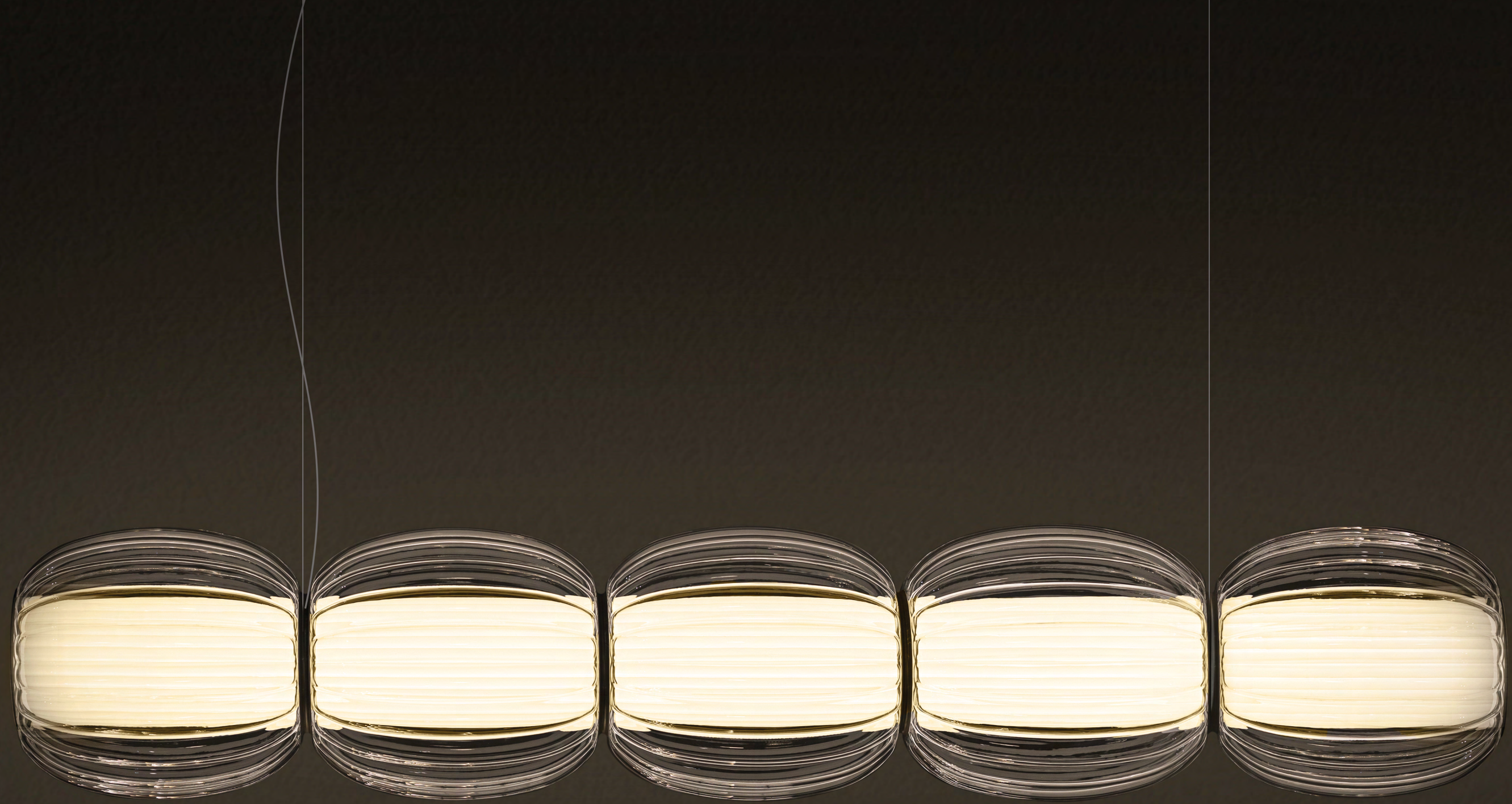



Alma Plurima suspension,
fumé glass finish.
Alma sospensione Plurima,
finitura vetro fumé.



Alma table lamp,
fabric diffuser and fumé glass detail.
Alma tavolo,
diffusore in tessuto con vetro fumé.



Totem floor lamp,
fumé glass finish.
Lampada da terra Totem,
finitura vetro fumé.



Alma

IP20



SUSPENSION / SOSPENSIONE

AURA

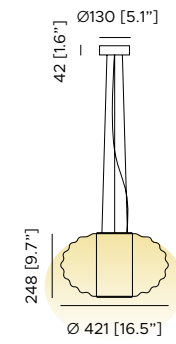

LUME

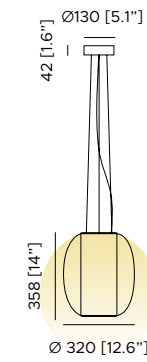

NOVA

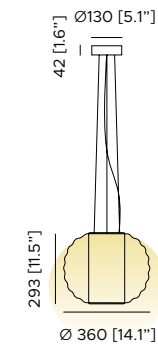

MULTIPLA

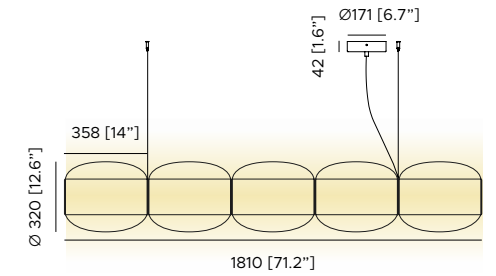

PLURIMA

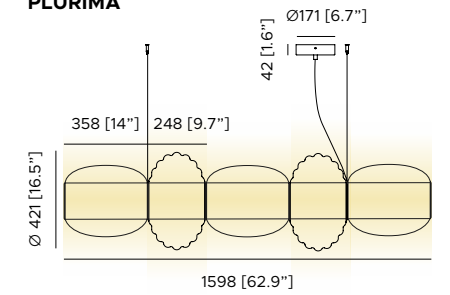

LIGHT SOURCE / FONTE LUMINOSA

AURA - LUME - NOVA

220-240V · 110V | 1x12 W LED module
2.280 Lm | 2.700 K | CRI >90

MULTIPLA

220-240V · 110V | 1x38 W Custom strip LED
5.456 Lm | 2.700 K | CRI >90

PLURIMA

220-240V · 110V | 1x32 W Custom strip LED
4.695 Lm | 2.700 K | CRI >90

Dimming / Dimmerazione

AURA - LUME - NOVA - MULTIPLA - PLURIMA

Phase cut (Triac) / Taglio di fase (Triac)
1-10V | DALI on demand / 1-10V | DALI su richiesta

FINISHES / FINITURE

Frame / Struttura

AURA - LUME - NOVA - MULTIPLA - PLURIMA

Golden nickel
Nickel dorato

Diffuser / Diffusore

AURA - LUME - NOVA

Amber colour glass
Vetro colore ambra
White fabric inside
Interno tessuto bianco

Plum colour glass
Vetro colore ametista

Fumé colour glass
Vetro colore fumé

MULTIPLA - PLURIMA

Fumé colour glass
Vetro colore fumé
White fabric inside
Interno tessuto bianco

CABLE / CAVO

2000mm [79.7"] standard

AURA - LUME - NOVA - MULTIPLA - PLURIMA

Coaxial cable
Cavo coassiale
Steel cables for the balance
Cavi di bilanciamento in acciaio

Extra cable / Cavo extra

Up to 5000 mm [196.8"] on demand / Fino a 5000 mm [196.8"] su richiesta

Alma

IP20



TABLE / TAVOLO

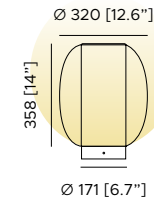

TOTEM

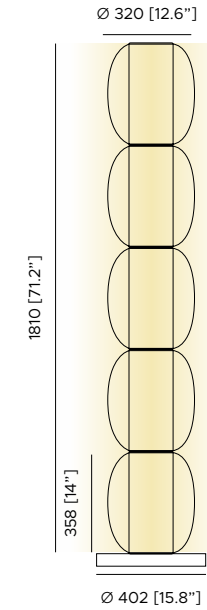

LIGHT SOURCE / FONTE LUMINOSA

Dimming / Dimmerazione

TABLE / TAVOLO

220-240V · 110V | 1x12 W LED module
2.280 Lm | 2.700 K | CRI >90

TABLE / TAVOLO

Dimmable switch on the base / Interruttore sulla base dimmerabile

TOTEM

Dimmable foot control / Interruttore a piede dimmerabile

FINISHES / FINITURE

Frame / Struttura

Diffuser / Diffusore

TABLE / TAVOLO - TOTEM

Golden nickel
Nickel dorato

TABLE / TAVOLO

Amber colour glass
Vetro colore ambra
White fabric inside
Interno tessuto bianco

Plum colour glass
Vetro colore ametista

Fumé colour glass
Vetro colore fumé

TOTEM

Fumé colour glass
Vetro colore fumé
White fabric inside
Interno tessuto bianco

CABLE / CAVO

2000mm [79.7"]
+ 300mm [11.8"] standard

TABLE / TAVOLO - TOTEM

Black colour fabric
Tessuto colore nero

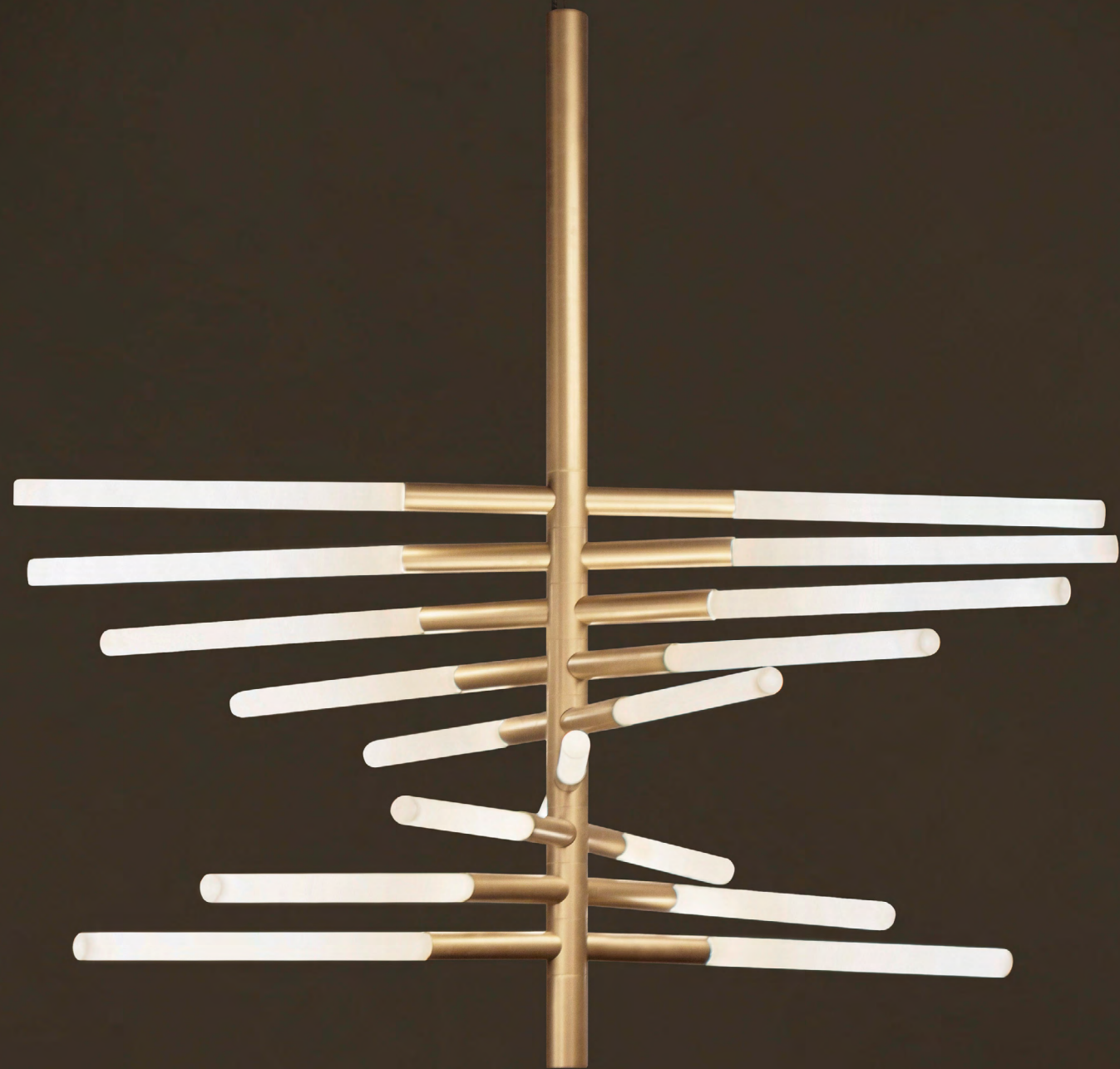

Bianca

DAINELLI STUDIO

Inspired by the perfect geometry of a snowflake, Bianca Twist introduces a new helical configuration that enhances the light's sense of lightness and dynamism. A striking presence, designed to define space with balance, elegance, and an aesthetic suspended between nature and engineering.

Ispirata alla geometria perfetta del fiocco di neve, Bianca Twist introduce una nuova configurazione elicoidale che esalta la leggerezza e il dinamismo della luce. Una presenza scenografica, pensata per definire lo spazio con equilibrio, eleganza e un'estetica sospesa tra natura e ingegneria, ideale per grandi ambienti e installazioni creative.





Bianca Twist suspension, bronze finish.
Bianca sospensione Twist, finitura bronzo.



Bianca Twist suspension detail,
bronze finish with Contardi logo.
Dettaglio di Bianca sospensione Twist,
finitura bronzo con logo Contardi.



Bianca

IP20



SUSPENSION / SOSPENSIONE

TWIST MEDIUM

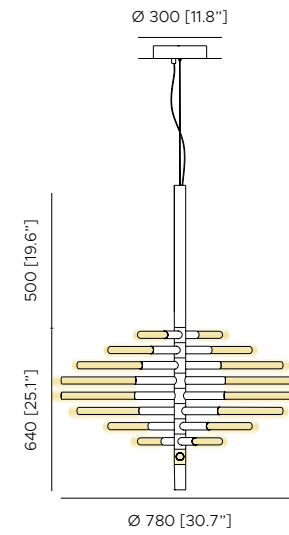

TWIST LARGE

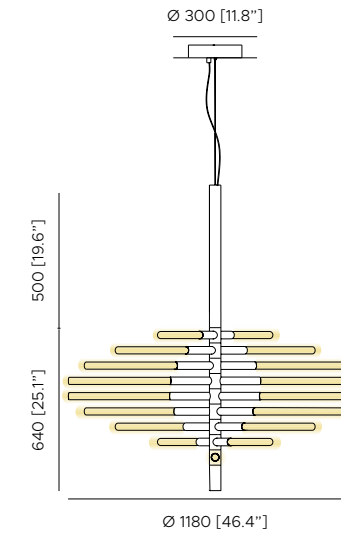

INCLUDED BULBS / LAMPADINE INCLUSE

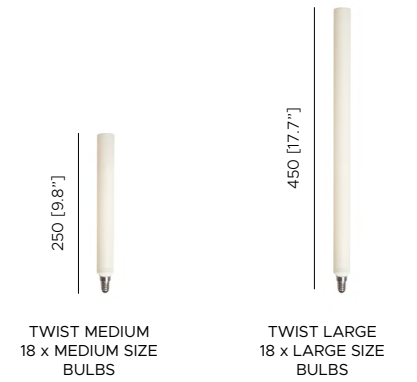

LIGHT SOURCE / FONTE LUMINOSA

TWIST MEDIUM

220-240V · 110V | 18x5.6 W Custom LED light bulbs
18x490 Lm (8.820 Lm tot.) | 3.000 K | CRI >90

TWIST LARGE

220-240V · 110V | 18x9.1 W Custom LED light bulbs
18x900 Lm (16.200 Lm tot.) | 3.000 K | CRI >90

Dimming / Dimmerazione

TWIST MEDIUM - TWIST LARGE

Phase cut (Triac) / Taglio di fase (Triac)
1-10V | DALI on demand / 1-10V | DALI su richiesta

FINISHES / FINITURE

Frame / Struttura

TWIST MEDIUM - TWIST LARGE

Gold Oro Bronze Bronzo

Diffuser / Diffusore

TWIST MEDIUM - TWIST LARGE

Milky white glass Vetro bianco latte

CABLE / CAVO

2000mm [79.7"] standard

TWIST MEDIUM - TWIST LARGE

Coaxial cable Cavo coassiale Steel cable for the balance Cavo di bilanciamento in acciaio

Extra cable / Cavo extra

Up to 5000 mm [196.8"] on demand / fino a 5000 mm [196.8"] su richiesta
Up to 10000 mm [393.7"] on demand / fino a 10000 mm [393.7"] su richiesta



Fly XL

MASSIMILIANO RAGGI

The Fly collection expands into new dimensions: Multipla pendant and linear wall sconce now reach up to 2400 mm, while a new Picture version extends to 1800 mm. Pure, lightweight luminous lines that discreetly traverse space—ideal for scenic and architectural projects where light and form coexist with harmony and precision.

La collezione Fly si estende in nuove dimensioni: sospensione Multipla e versione a parete lineare raggiungono i 2400 mm, mentre il modello Picture si estende fino a 1800 mm. Segni luminosi puri e leggeri che attraversano lo spazio con discrezione, ideali per progetti scenografici e architettonici, in cui luce e forma convivono con armonia e precisione.

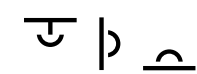





Fly XL wall lamp, brushed bronze-nickel finish,
height 2400 mm.
Lampada a parete Fly XL, finitura bronzo-nickel
spazzolato, altezza 2400 mm.



Detail of Fly XL Picture,
satin golden nickel finish.
Dettaglio di Fly XL Picture,
finitura nickel dorato satinato.





Fly XL

IP20

SUSPENSION / SOSPENSIONE

MULTIPLA L.2400

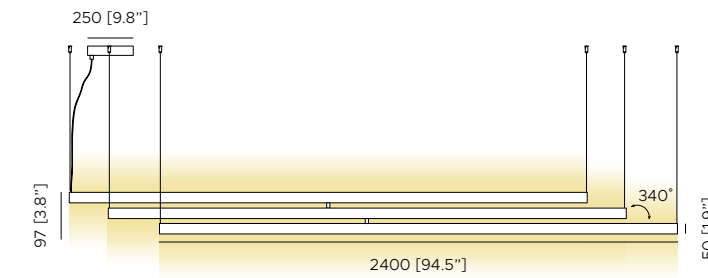

LIGHT SOURCE / FONTE LUMINOSA

MULTIPLA L.2400

220-240V · 110V

Upper emission / Emissione superiore 1x98 W Strip LED | 12.544 Lm

Lower emission / Emissione inferiore 1x99 W Strip LED | 12.672 Lm

2.700 K | CRI >90

Dimming / Dimmerazione

MULTIPLA L.2400

Phase cut (Triac) / Taglio di fase (Triac)

1-10V | DALI on demand / 1-10V | DALI su richiesta

FINISHES / FINITURE

Frame / Struttura

MULTIPLA L.2400

 Satin golden nickel
Nickel dorato satinato

 Brushed bronze-nickel
Bronzo-nickel spazzolato

CABLE / CAVO

2000mm [79.7"] standard

MULTIPLA L.2400

 Transparent steel
Acciaio trasparente

 Steel cables for the balance
Cavi di bilanciamento in acciaio

Extra cable / Cavo extra

Up to 5000 mm [196.8"] on demand / fino a 5000 mm [196.8"] su richiesta
Up to 10000 mm [393.7"] on demand / fino a 10000 mm [393.7"] su richiesta

Fly XL

IP20 | IP44

WALL / PARETE

WALL H.2400

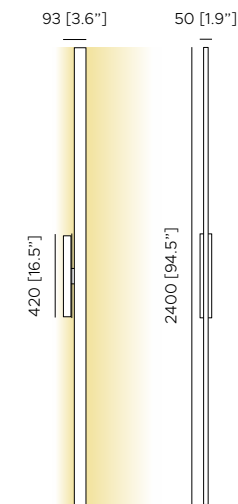

Supplied with square plate to cover junction box for North American market.

PICTURE L.1800

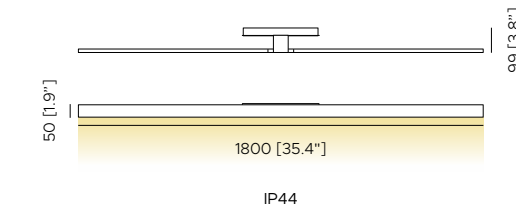

Supplied with square plate to cover junction box for North American market.

FLOOR / PIANTANA

LONG H.2470

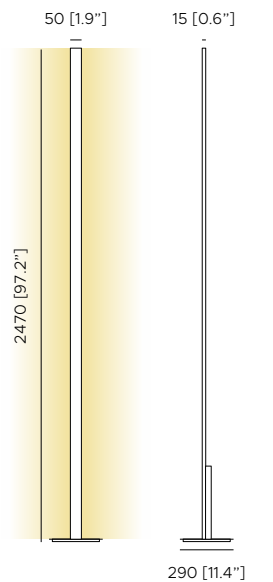

LIGHT SOURCE / FONTE LUMINOSA

WALL H.2400 / PARETE H.2400

220-240V · 110V
 Front emission / Emissione frontale 1x33.6 W Strip LED | 2.920 Lm
 Back emission / Emissione retro 2x24 W Strip LED | 4.360 Lm
 2.700 K | CRI >90

PICTURE L.1800

220-240V · 110V | 1x35 W Strip LED
 4.140 Lm | 2.700 K | CRI >90 | IP44

LONG H.2470

220-240V · 110V
 Front emission / Emissione frontale 1x34.5 W Strip LED | 4.050 Lm
 Back emission / Emissione retro 1x49 W Strip LED | 5.800 Lm
 2.700 K | CRI >90

Dimming / Dimmerazione

WALL H.2400 / PARETE H.2400 - PICTURE L.1800

Phase cut (Triac) / Taglio di fase (Triac)
 1-10V | DALI on demand / 1-10V | DALI su richiesta

LONG H.2470

Dimmable with double switch on board / Dimmerabile con doppio interruttore a bordo

FINISHES / FINITURE

Frame / Struttura

WALL H.2400 / PARETE H.2400 - PICTURE L.1800 - LONG H.2470

Satin golden nickel
 Brushed bronze-nickel
 Nickel dorato satinato Bronzo-nickel spazzolato

CABLE / CAVO

2000mm [79.7"]
 + 300mm [11.8"] standard

LONG H.2470

Black colour fabric
 Tessuto colore nero



Hat

PAOLA NAVONE - OTTO STUDIO

Essential yet full of character, Hat is a tribute to 1950s French design. The pendant, table, and floor lamps, covered with rope and topped with white lampshades, celebrate a relaxed elegance. Material and light interact in perfect harmony, balancing craftsmanship with a contemporary vision, all with a touch of sophisticated vintage charm.

Essenziale ma ricca di carattere, Hat è un omaggio al design francese degli anni '50. Le lampade a sospensione, da tavolo e da terra, rivestite in corda e illuminate da paralumi bianchi, celebrano un'eleganza rilassata. Materia e luce dialogano in perfetto equilibrio tra artigianalità e visione contemporanea, con un tocco vintage sofisticato.

OTTO





Covering rope, japanese red finish.
Available also in graphite grey colour.
Corda di rivestimento, finitura rosso giapponese.
Disponibile anche nella colorazione grigio grafite.



Hat floor lamp, white linen lampshade
and graphite grey rope stem.
Lampada da terra Hat, paralume in lino bianco,
stelo rivestito in corda grigio grafite.



Hat table lamp, white linen lampshade, and japanese red rope.
Available also with tyvek lampshade and graphite grey rope.
Hat tavolo, paralume in lino bianco, stelo in corda rosso giapponese.
Disponibile anche con paralume in tyvek e corda grigio grafite.

Hat

IP20

SUSPENSION / SOSPENSIONE

MEDIUM

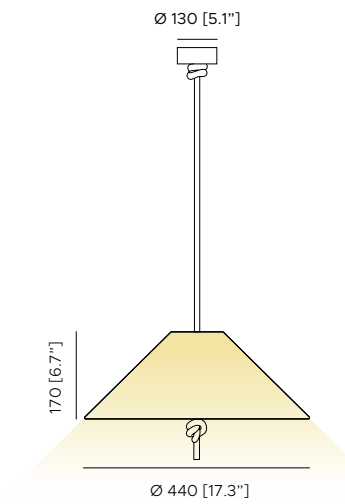

LARGE

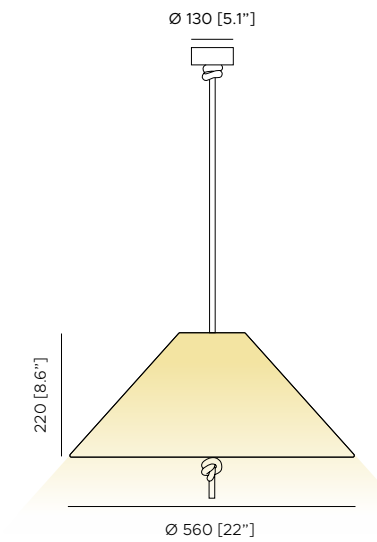

LIGHT SOURCE / FONTE LUMINOSA

MEDIUM

220-240V · 110V | 1x12 W LED module
1.440 Lm | 3.000 K | CRI >90

LARGE

220-240V · 110V | 1x14 W LED module
1.680 Lm | 3.000 K | CRI >90

Dimming / Dimmerazione

Phase cut (Triac) / Taglio di fase (Triac)

FINISHES / FINITURE

Canopy / Rosone

MEDIUM - LARGE

Graphite grey
Grigio grafite

Japanese red
Rosso giapponese

Diffuser / Diffusore

MEDIUM - LARGE

White linen
Lino bianco

Tyvek
Tyvek

CABLE / CAVO

2000mm [79.7"] standard

MEDIUM - LARGE

Graphite grey rope
Corda grigio grafite

Japanese red rope
Corda rosso giapponese

Extra cable / Cavo extra

Up to 5000 mm [196.8"] on demand / fino a 5000 mm [196.8"] su richiesta





Hat

IP20

TABLE / TAVOLO

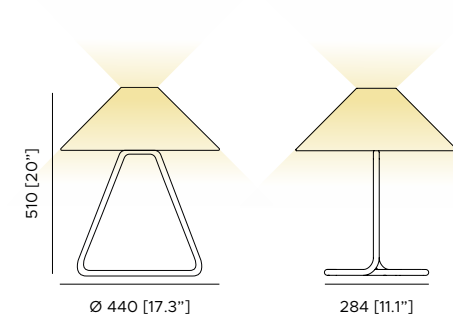

FLOOR / PIANTANA

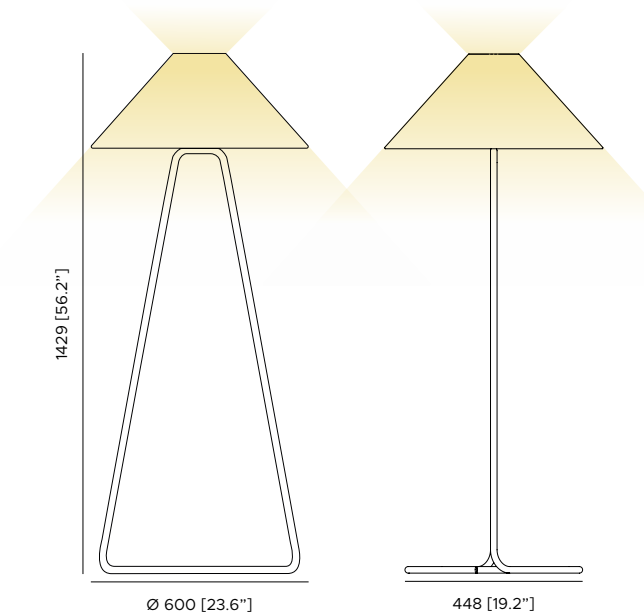

LIGHT SOURCE / FONTE LUMINOSA

TABLE / TAVOLO

220-240V | 1x11 W E27 full light LED bulb
Bulb not included / Lampadina non inclusa

FLOOR / PIANTANA

220-240V | 1x12 W E27 full light LED bulb
Bulb not included / Lampadina non inclusa

TABLE / TAVOLO

110V | 1x11 W E26 full light LED bulb
Bulb not included / Lampadina non inclusa

FLOOR / PIANTANA

110V | 1x12 W E26 full light LED bulb
Bulb not included / Lampadina non inclusa

Dimming / Dimmerazione

TABLE / TAVOLO

Dimmable switch on the cable / Interruttore su cavo dimmerabile

FLOOR / PIANTANA

Dimmable foot control / Interruttore a piede dimmerabile

FINISHES / FINITURE

Frame / Struttura

TABLE / TAVOLO - FLOOR / PIANTANA

Graphite grey rope / Corda grigio grafite
Japanese red rope / Corda rosso giapponese

Diffuser / Diffusore

TABLE / TAVOLO - FLOOR / PIANTANA

White linen / Lino bianco
Tyvek / Tyvek

CABLE / CAVO

2000mm [79.7"]
+ 300mm [11.8"] standard

TABLE / TAVOLO - FLOOR / PIANTANA

Black colour fabric / Tessuto colore nero



Picchio

ALESSANDRO MUNGE

Inspired by the grace of the woodpecker, the collection reimagines the reading lamp as a sculptural and interactive object. Available in wall and table versions, it blends mechanics, elegance, and freedom of movement, offering precise, ergonomic, and poetic light. Ideal for both residential spaces and contract settings that demand functionality and style.

Ispirata alla grazia del picchio, la collezione reinterpreta la lampada da lettura come oggetto scultoreo e interattivo. In versione da parete e da tavolo, combina meccanica, eleganza e libertà di movimento, offrendo una luce precisa, ergonomica e poetica. Ideale per spazi domestici e ambienti contract che richiedono funzionalità e stile.





INDOOR



Picchio wall lamp,
bronze-nickel finish, driver on board.
Lampada a parete Picchio,
finitura bronzo-nickel, driver integrato.





Picchio table lamp, polished aluminum structure,
cognac leather details.
Lampada da tavolo Picchio, struttura in alluminio lucido,
dettagli in pelle colore cognac.

Picchio

IP20



WALL / PARETE

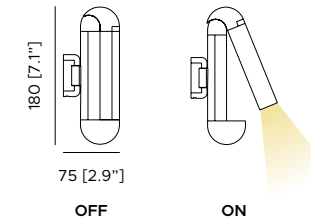

WITHOUT BASE
(remote driver)
SENZA BASE
(driver remoto)

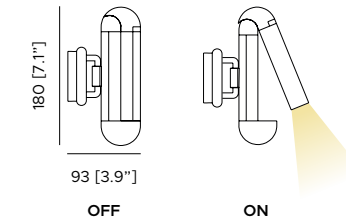

WITH BASE
(driver on board)
CON BASE
(driver integrato)

Supplied with round plate
to cover junction box
for North American market.

TABLE / TAVOLO

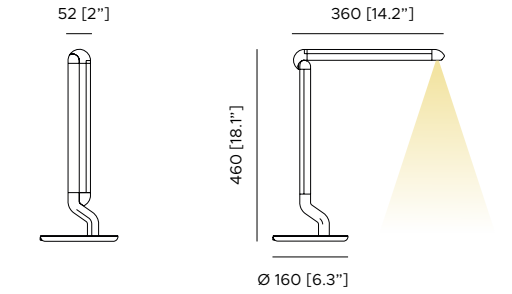

MOVEMENT / MOVIMENTO

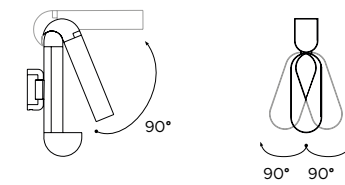

SIDE VIEW
(opening)
VISTA LATERALE
(apertura)

TOP VIEW
(rotation)
VISTA SUPERIORE
(rotazione)

MOVEMENT / MOVIMENTO

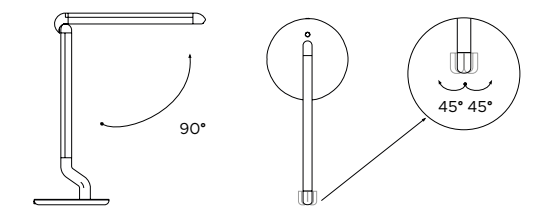

SIDE VIEW
(opening)
VISTA LATERALE
(apertura)

TOP VIEW
(rotation)
VISTA SUPERIORE
(rotazione)

LIGHT SOURCE / FONTE LUMINOSA

Dimming / Dimmerazione

FINISHES / FINITURE

Frame with leather details /
Struttura con dettagli in pelle

Frame without leather details /
Struttura senza dettagli in pelle

CABLE / CAVO

2000mm [79.7"]
+ 300mm [11.8"] standard

WALL / PARETE - TABLE / TAVOLO

220-240V · 110V | 1x3 W LED module
500 Lm | 2.700 K | CRI >90

TABLE / TAVOLO

Dimmable switch on the base / Interruttore sulla base dimmerabile

WALL / PARETE - TABLE / TAVOLO

| | |
|----------------------------------------|-------------------------------------|
| Polished aluminium Alluminio lucido | Bronze-nickel Bronzo-nickel |
| Cognac leather Pelle cognac | Coffee leather Pelle color caffè |

WALL / PARETE - TABLE / TAVOLO

| | |
|----------------------------------------|--------------------------------|
| Polished aluminium Alluminio lucido | Bronze-nickel Bronzo-nickel |
|----------------------------------------|--------------------------------|

TABLE / TAVOLO

| |
|--------------------------------------------|
| Black colour fabric Tessuto colore nero |
|--------------------------------------------|

Outdoor



Bloom

DAAA HAUS

Bloom brings the elegance of a blossoming flower to the garden. With fluid lines inspired by the calla lily, this outdoor collection by DAAA Haus is designed to blend seamlessly with nature. The silicone diffuser softens the light, creating a warm, theatrical atmosphere in any open-air space, whether private or contract, enhancing every detail.

Bloom porta nei giardini l'eleganza di un fiore che sboccia. Con linee fluide ispirate alla calla, la collezione outdoor firmata DAAA Haus è pensata per fondersi con la natura. Il diffusore in silicone ammorbidisce la luce, creando atmosfere avvolgenti e scenografiche in ogni spazio open air, sia privato che contract, valorizzando ogni dettaglio.

h





Bloom outdoor lamp IP65, with glowing pistil.
Lampada da esterno IP65 Bloom, con pistillo luminoso.



Detail of Bloom soft petal diffuser.
Dettaglio del diffusore morbido a petalo di Bloom.



Bloom

IP65

FLOOR / TERRA

TINY

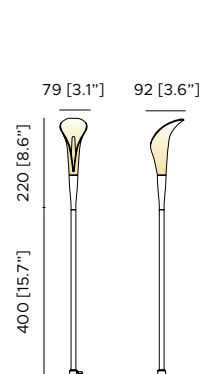

LONG

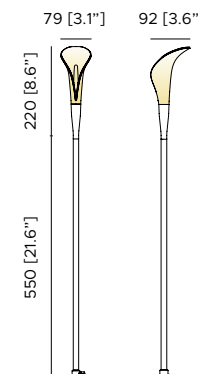

TINY

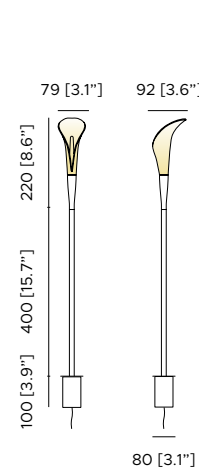

LONG

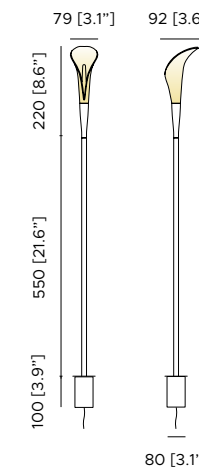

WITHOUT ANCHORING (remote driver)
SENZA ANCORAGGIO (driver remoto)

WITH ANCHORING (driver on board)
CON ANCORAGGIO (driver integrato)

FIXING ACCESSORIES FOR BLOOM WITH REMOTE DRIVER / ACCESSORI PER FISSAGGIO BLOOM CON DRIVER REMOTO

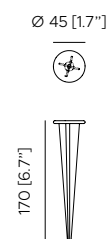
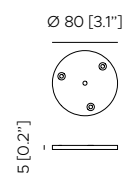

Floor anchoring
Fissaggio a pavimento

Ground anchoring
Picchetto per terreno

LIGHT SOURCE / FONTE LUMINOSA

TINY - LONG
220-240V · 110V | 1x3 W LED module
500 Lm | 2.700 K | CRI >90

FINISHES / FINITURE

Frame / Struttura

TINY - LONG
Dark green
Verde scuro

Diffuser / Diffusore

TINY - LONG
White silicon
Silicone bianco

CABLE / CAVO

2000mm [79.7"] standard

TINY - LONG
Black
Nero



Clara

CHIARA CABERLON
IN COLLABORATION WITH MARCO FORBICIONI

Clara is renewed with new finishes and features: the warmth of Vienna straw in a chocolate colour and a wired version of the lamp. With the floor stand accessory for the battery-powered version, available in two heights, Clara gracefully adapts to any setting, blending tradition and innovation, and offering new compositional possibilities for residential or refined hospitality projects.

Clara si veste di nuove finiture e funzionalità: il calore della paglia di Vienna nel colore cioccolato e la versione cablata della lampada. Con l'accessorio piantana per la declinazione a batteria, in due altezze, Clara si adatta con grazia a ogni ambiente, tra tradizione e innovazione, offrendo nuove possibilità compositive per progetti residenziali o di hôtellerie sofisticata.

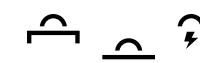





Detail of Clara battery version,
chocolate resin diffuser with Vienna straw effect.
Dettaglio di Clara versione a batteria,
diffusore in resina effetto paglia di Vienna, colore cioccolato.

Clara small battery version, bronze frame,
chocolate resin diffuser with Vienna straw effect.
Clara versione a batteria small, struttura bronzo,
diffusore in resina effetto paglia di Vienna, colore cioccolato.



Clara

IP65



BATTERY / BATTERIA - WIRED / CABLATA

SMALL

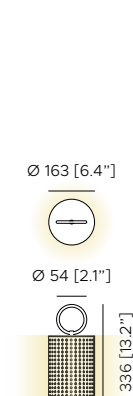

MEDIUM

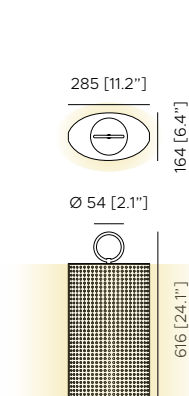

LARGE

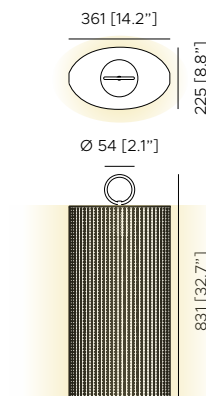

CLARA SMALL BATTERY ACCESSORY / ACCESSORIO CLARA SMALL BATTERIA

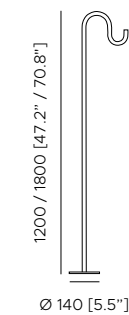

With base for fixing to the floor
Con base per fissaggio a terra

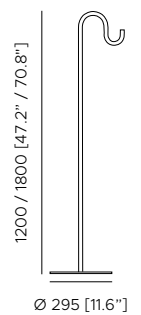

free standing

LIGHT SOURCE / FONTE LUMINOSA

BATTERY / BATTERIA

220-240V · 110V | 1x3 W LED module
400 Lm | 3.000 K | CRI >90

WIRED / CABLATA

220-240V | 1x5 W E27 LED
Bulb h. max. 95mm
Bulb not included | Lampadina non inclusa

WIRED / CABLATA

110V | 1x5 W E26 LED
Bulb h. max. 95mm
Bulb not included | Lampadina non inclusa

FINISHES / FINITURE

Frame / Struttura

BATTERY / BATTERIA - WIRED / CABLATA

Bronze
 Matt white
 Bronzo Bianco opaco

Diffuser / Diffusore

BATTERY / BATTERIA - WIRED / CABLATA

Vienna straw resin effect
 Vienna straw resin effect chocolate colour
 Resina effetto paglia di Vienna
 (only with bronze lacquered frame)
 Resina effetto paglia di Vienna colore cioccolato (solo con struttura laccato bronzo)

Accessory / Accessorio

CLARA SMALL BATTERY / CLARA BATTERIA SMALL

Bronze
 Bronzo

CABLE / CAVO

2000mm [79.7"] standard

WIRED / CABLATA

Black
 Nero



Kiki

CONTARDI STUDIO

Kiki expands to outdoor settings with new IP65 versions, available as wall-mounted with or without a base. Essential and versatile, this wall light brings the elegance of pop design outdoors, ensuring performance and durability without compromising style. A contemporary icon that combines technical functionality with aesthetic personality.

Kiki si apre all'outdoor con le nuove versioni IP65, da parete con o senza basetta. Essenziale e versatile, questa applique porta l'eleganza del design pop anche all'esterno, garantendo performance e resistenza, senza rinunciare allo stile. Un'icona contemporanea capace di coniugare funzionalità tecnica e personalità estetica.







Kiki Zest outdoor lamp IP65,
white opal glass diffuser, deep black frame.
Lampada outdoor IP65 Kiki Zest,
diffusore in vetro opale bianco, struttura nero intenso.



Kiki

IP65

WALL / PARETE - CEILING / PLAFONE

BUD

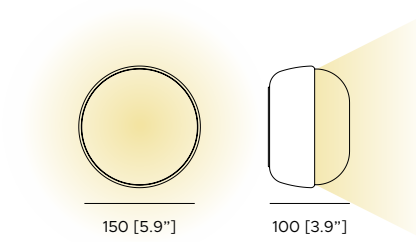

WALL / PARETE

ZEST

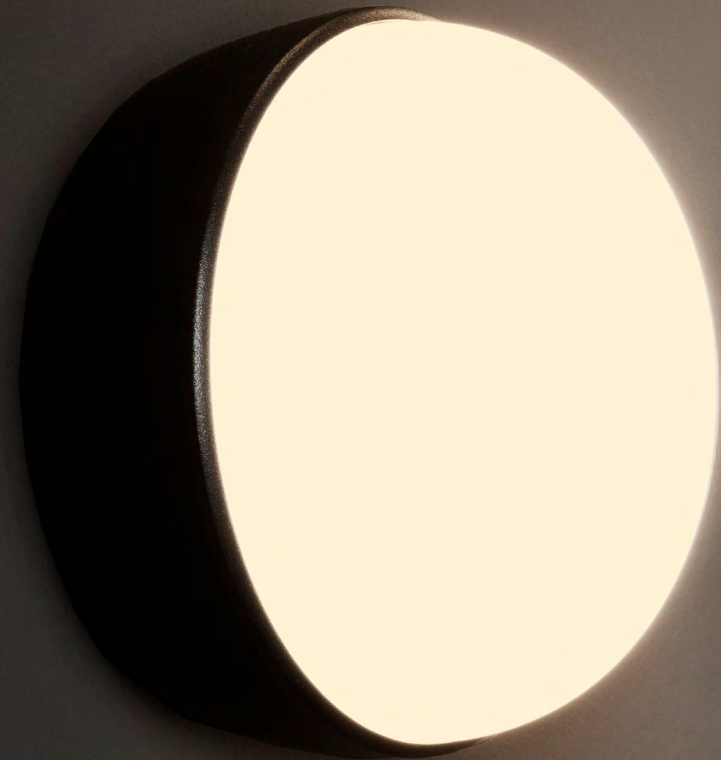
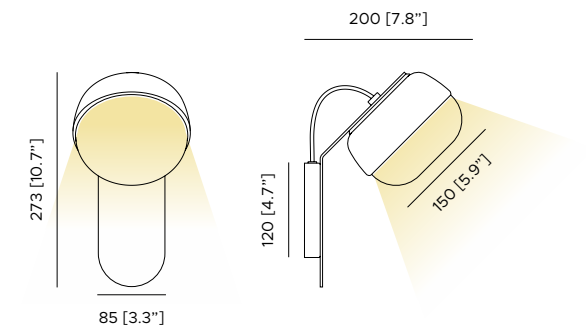

LIGHT SOURCE / FONTE LUMINOSA

BUD - ZEST
220-240V · 110V | 1x4.5 W Custom LED
495 Lm | 2.700 K | CRI >90

FINISHES / FINITURE
Frame / Struttura

BUD - ZEST
■ Deep black
Nero intenso

Diffuser / Diffusore

BUD - ZEST
■ Opal white glass
Vetro bianco opale



THANKS TO

Graphic Project

Dainelli Studio
Claudia Parisi
Blackspace

Mise en page

Claudia Parisi
Martina Castiglieri

Photography

Carolina Gheri
Controvento
Marco Reggi

Render

Dainelli Studio
Truetopia

Print

Grafiche Antiga, Crocetta del Montello (TV)

© Contardi Lighting Srl
09.2025

The images are for illustrative purposes only.
Our finishes are the result of delicate handcraft processes.

Le immagini sono inserite a solo scopo illustrativo. Le nostre finiture sono il risultato di delicati processi di lavorazione artigianale.

All rights reserved. No part of this publication may be reproduced or transmitted in any form or by any means, electronic or mechanical, without prior permission of the owner. All copyrights and intellectual property rights, including trademarks, patents and copyrights, remain the property of Contardi Lighting Srl and are explicitly reserved.

Tutti i diritti sono riservati. Nessuna parte di questa pubblicazione può essere riprodotta o trasmessa in alcuna forma o con alcun mezzo, elettronico o meccanico, senza il permesso preventivo del proprietario. Tutti i diritti d'autore e di proprietà intellettuale, inclusi marchi, brevetti e copyright, restano di proprietà di Contardi Lighting Srl e sono espressamente riservati.

CONTARDI LIGHTING SRL
Headquarters

Via A. Manzoni, 134/140
20811 Cesano Maderno – MB
Italy

Tel. +39 0362 301381
sales@contardi-italia.it

CONTARDI MILANO
Showroom

Corso Monforte, 20
20122 Milano – MI
Italy

Tel. +39 02 82765952
milano@contardi-italia.it

CONTARDI USA, INC.
USA Branch

303 5th Avenue, Suite 706
10016 New York - NY
United States

Tel. +1 718 715 0717
info@contardi-usa.com

Follow Contardi Lighting on:



