

Kiki

CONTARDI STUDIO



Kiki

CONTARDI STUDIO



BUD
WALL|CEILING



ZEST
WALL

Kiki expands to outdoor settings with new IP65 versions, available as wall-mounted with or without a base. Essential and versatile, this wall light brings the elegance of pop design outdoors, ensuring performance and durability without compromising style. A contemporary icon that combines technical functionality with aesthetic personality.

Kiki si apre all'outdoor con le nuove versioni IP65, da parete con o senza basetta. Essenziale e versatile, questa applique porta l'eleganza del design pop anche all'esterno, garantendo performance e resistenza, senza rinunciare allo stile. Un'icona contemporanea capace di coniugare funzionalità tecnica e personalità estetica.

P3

Kiki Bud

P4

Kiki Zest

KIKI BUD

LIGHT EFFECT | EFFETTO LUMINOSO

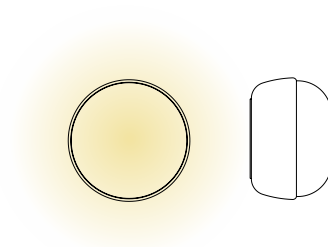
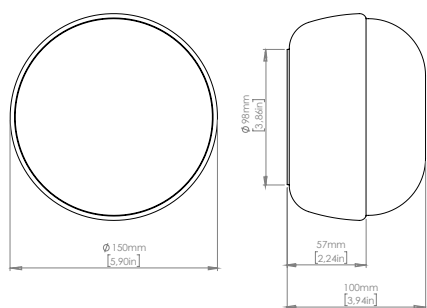

LIGHT SOURCE | FONTE LUMINOSA

220-240V · 110V | 1x4.5 W Custom LED
495 Lm | 2.700 K | CRI >90 | IP65

FINISHES | FINITURE

METAL FRAME | STRUTTURA METALLICA

 Deep black
Nero intenso

GLASS DIFFUSER | DIFFUSORE IN VETRO

 Opal white
Bianco opale

Packaging | Imballi

BUD	220x200xh.200mm [8.6"x7.8"xh.7.8"]
	1 kg [2.2 lbs]

LIGHT EFFECT | EFFETTO LUMINOSO

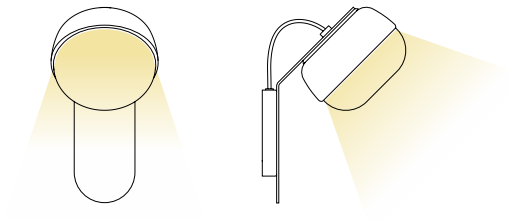
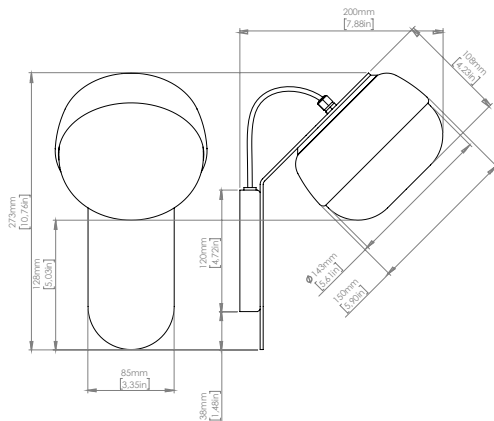

LIGHT SOURCE | FONTE LUMINOSA

220-240V · 110V | 1x4.5 W Custom LED
495 Lm | 2.700 K | CRI >90 | IP65

FINISHES | FINITURE

METAL FRAME | STRUTTURA METALLICA

 Deep black
Nero intenso

GLASS DIFFUSER | DIFFUSORE IN VETRO

 Opal white
Bianco opale

Packaging | Imballi

ZEST	220x220x370mm [8.6x8.6x14.5]
	2 kg [4.4 lbs]



CONTARDI LIGHTING Srl

ITALY HEADQUARTERS
contardi-italia.com

CONTARDI USA Inc

USA BRANCH
contardi-usa.com

Copyright and/or design rights subsist in this drawing. No part of this drawing may be reproduced in any material form (including photocopying or storing in any medium electronic means, whether or not intentionally and whether or not as part or a larger publication) without the express permission of the copyright owner, Contardi Lighting S.r.l.. Further and without prejudice to the above, this drawing and all information relating thereto is confidential, and shall not be communicated to a third party without the consent of Contardi lighting srl. Contardi Lighting Srl asserts all rights to be identified as the author of the work and otherwise.

WARNING: The doing of any unauthorised act in relation to a copyright work may result in both a civil claim for damages and criminal prosecution.