

Picchio

ALESSANDRO MUNGE



Picchio

ALESSANDRO MUNGE



WITH BASE | WITHOUT BASE

WALL



TABLE

Inspired by the grace of the woodpecker, the collection reimagines the reading lamp as a sculptural and interactive object. Available in wall and table versions, it blends mechanics, elegance, and freedom of movement, offering precise, ergonomic, and poetic light. Ideal for both residential spaces and contract settings that demand functionality and style.

Ispirata alla grazia del picchio, la collezione reinterpretava la lampada da lettura come oggetto scultoreo e interattivo.

In versione da parete e da tavolo, combina meccanica, eleganza e libertà di movimento, offrendo una luce precisa, ergonomica e poetica. Ideale per spazi domestici e ambienti contract che richiedono funzionalità e stile.

- P3 **Picchio wall without base**
- P4 **Picchio wall with base**
- P5 **Picchio table**

WITHOUT BASE

LIGHT EFFECT | EFFETTO LUMINOSO

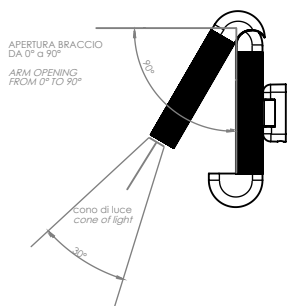
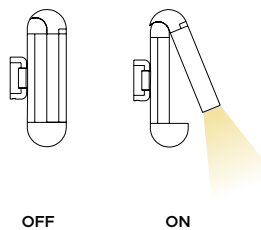
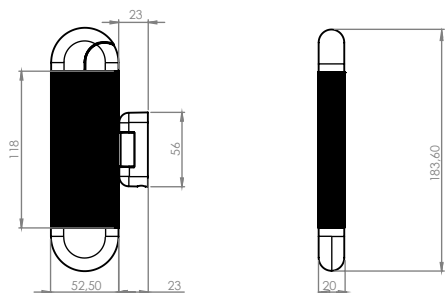





LIGHT SOURCE | FONTE LUMINOSA



220-240V · 110V | 1x3 W LED module
500 Lm | 2.700 K | CRI >90

FINISHES | FINITURE

FRAME WITH LEATHER DETAILS | STRUTTURA CON DETTAGLI IN PELLE

- | | |
|--|--|
|  Polished aluminium Alluminio lucido |  Bronze-nickel Bronzo-nickel |
|  Cognac leather Pelle cognac |  Coffee leather Pelle caffè |

FRAME WITHOUT LEATHER DETAILS | STRUTTURA SENZA DETTAGLI IN PELLE

- | | |
|--|--|
|  Polished aluminium Alluminio lucido |  Bronze-nickel Bronzo-nickel |
|--|--|

Packaging | Imballi

| | |
|----------------------|----------------------------------|
| REMOTE DRIVER | 215x120xh.55mm [8.4"x4.7"xh2.1"] |
| | 0,4 kg [0.8 lbs] |

LIGHT EFFECT | EFFETTO LUMINOSO

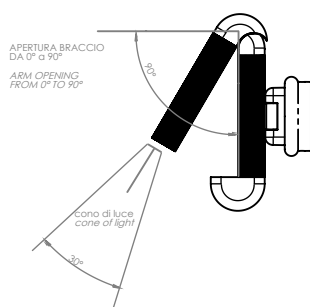
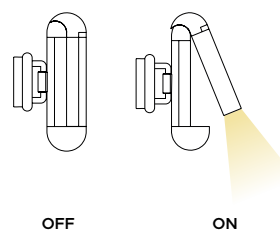
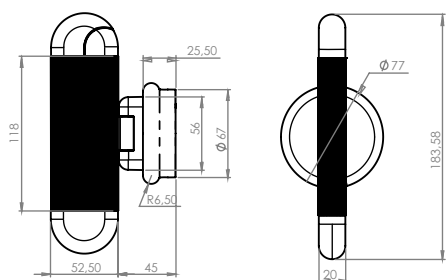





LIGHT SOURCE | FONTE LUMINOSA



220-240V · 110V | 1x3 W LED module
500 Lm | 2.700 K | CRI >90

FINISHES | FINITURE

FRAME WITH LEATHER DETAILS | STRUTTURA CON DETTAGLI IN PELLE

- | | |
|--|--|
|  Polished aluminium Alluminio lucido |  Bronze-nickel Bronzo-nickel |
|  Cognac leather Pelle cognac |  Coffee leather Pelle caffè |

FRAME WITHOUT LEATHER DETAILS | STRUTTURA SENZA DETTAGLI IN PELLE

- | | |
|--|--|
|  Polished aluminium Alluminio lucido |  Bronze-nickel Bronzo-nickel |
|--|--|

Packaging | Imballi

| | |
|------------------------|----------------------------------|
| DRIVER ON BOARD | 215x120xh.55mm [8.4"x4.7"xh2.1"] |
| | 0,5 kg [1.1"] |

TABLE

LIGHT EFFECT | EFFETTO LUMINOSO

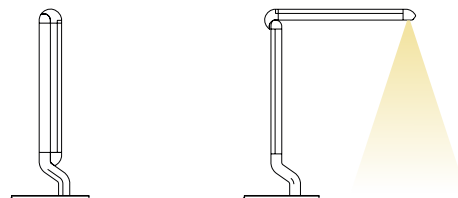
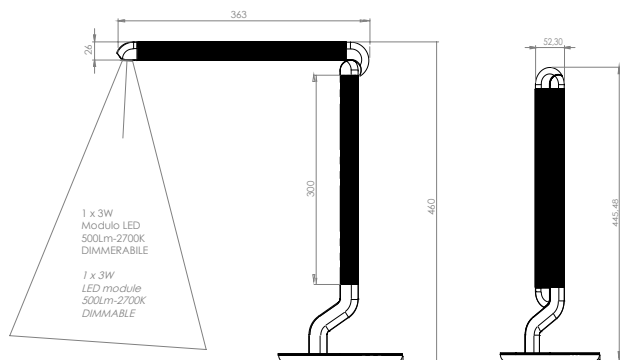

LIGHT SOURCE | FONTE LUMINOSA

220-240V · 110V | 1x3 W LED module
500 Lm | 2.700 K | CRI >90

DIMMING | DIMMERAZIONE

Dimmer on board | Dimmer a bordo

FINISHES | FINITURE

FRAME WITH LEATHER DETAILS | STRUTTURA CON DETTAGLI IN PELLE

- Polished aluminium
Alluminio lucido
- Bronze-nickel
Bronzo-nickel
- Cognac leather
Pelle cognac
- Coffee leather
Pelle caffè

FRAME WITHOUT LEATHER DETAILS | STRUTTURA SENZA DETTAGLI IN PELLE

- Polished aluminium
Alluminio lucido
- Bronze-nickel
Bronzo-nickel

Packaging | Imballi

| | |
|--------------|-------------------------------------|
| TABLE | 200x200xh.500mm [7.8"x7.8"xh.19.6"] |
| | 3,5 kg [6.6 lbs] |



CONTARDI LIGHTING Srl

ITALY HEADQUARTERS
contardi-italia.com

CONTARDI USA Inc

USA BRANCH
contardi-usa.com

Copyright and/or design rights subsist in this drawing. No part of this drawing may be reproduced in any material form (including photocopying or storing in any medium electronic means, whether or not intentionally and whether or not as part or a larger publication) without the express permission of the copyright owner, Contardi Lighting S.r.l.. Further and without prejudice to the above, this drawing and all information relating thereto is confidential, and shall not be communicated to a third party without the consent of Contardi lighting srl. Contardi Lighting Srl asserts all rights to be identified as the author of the work and otherwise.

WARNING: The doing of any unauthorised act in relation to a copyright work may result in both a civil claim for damages and criminal prosecution.